



5GIGE VISION CAMERAS

Alvium G5/G5X User Guide

V2.0.0

FW 00.13.01.794391f9

Note: Lenses are not part of this product.

**Quick links**

- [Alvium G5/G5X cameras at a glance](#) on page 15
- [Contact us](#) on page 19
- [Contents](#) on page 20

Read before use

EN - English

Safety

Before using the camera, read these safety instructions. Observe the warnings at all times. Use the camera only as stated in the [Intended use](#) on page 39.

**CAUTION****Risk of burns**

A camera in operation can reach temperature levels which could cause burns.

**CAUTION****Injury by falling cameras or lenses**

A falling camera or lens can cause injury.

**CAUTION****Risk of cuts by sharp edges of lens mounts**

The threads of the lens mount can have sharp edges.

Intended use

Intended use of Allied Vision product is the integration into vision systems by professionals. All Allied Vision product is sold in a B2B setting.

DA - Dansk

Sikkerhed

Læs sikkerhedsanvisningerne, før kameraet bruges. Overhold alle advarsler. Brug kun kameraet som anført i [Intended use](#) på side 39.



FORSIGTIG

Forbrændingsfare

Når kameraet bruges, kan det blive meget varmt og forårsage forbrændinger.



FORSIGTIG

Kvæstelser, hvis kameraet eller linser falder ned

Falder kameraet eller linsen ned, kan dette forårsage kvæstelser.



FORSIGTIG

Fare for snitsår på linsemodulets skarpe kanter

Linsemodulets gevind kan have skarpe kanter.

Tilsligtet brug

Allied Vision produktets tilsligtede brug er en indbygning i et visionssystem, udført af fagfolk. Alle Allied Vision produkter sælges i B2B.

DE - Deutsch

Sicherheit

Bevor Sie die Kamera benutzen, lesen Sie diese Sicherheitshinweise. Beachten Sie diese Hinweise immer. Verwenden Sie die Kamera nur wie beschrieben in [Intended use](#) auf Seite 39.



VORSICHT

Gefahr von Verbrennungen

Im Betrieb kann die Kamera Temperaturen erreichen, die zu Verbrennungen führen.



VORSICHT

Verletzung durch fallende Kameras oder Objektive

Eine fallende Kamera oder ein fallendes Objektiv kann Verletzungen verursachen.



VORSICHT

Schnitte durch scharfkantige Objektivgewinde

Objektivgewinde können scharfe Kanten haben.

Bestimmungsgemäßer Gebrauch

Allied Vision Produkte sind bestimmt für die Integration in Bildverarbeitungssysteme durch Fachpersonal. Alle Allied Vision Produkte werden in einer B2B-Umgebung verkauft.

ES - Español

Seguridad

Antes de utilizar la cámara lea estas instrucciones de seguridad. Observe las advertencias en todo momento. Utilice la cámara solo tal y como se estipula en el [Intended use](#) en la página 39.



ATENCIÓN

Riesgo de quemaduras

Una cámara en funcionamiento puede alcanzar temperaturas que podrían provocar quemaduras.



ATENCIÓN

Lesiones en caso de que las cámaras o las lentes se caigan

Si una cámara o una lente se cae puede provocar lesiones.



ATENCIÓN

Riesgo de cortes debido a los bordes afilados del objetivo

Las roscas de los objetivos pueden tener bordes afilados.

Uso previsto

El uso previsto del producto Allied Vision es la integración en el sistema de visión por parte de profesionales. Todos los productos Allied Vision se venden dentro de una relación B2B.

FI - Suomi

Turvallisuus

Lue nämä turvallisuusohjeet ennen kameran käyttöä. Noudata varoituksia joka hetki. Käytä kameraa ainoastaan kohdassa [Intended use](#) sivulla 39 kuvatulla tavalla.



HUOMIO

Palovammojen vaara

Käytössä olevan kameran saavuttamat lämpötilatasot voivat aiheuttaa palovammoja.



HUOMIO

Putoavien kameroiden tai linssien aiheuttamat vammat

Putoava kamera tai linssi voi aiheuttaa vammoja.



HUOMIO

Linssien kiinnikkeiden terävien reunojen aiheuttamien viiltovammojen vaara

Linssin kiinnikkeiden kierteiden reunat voivat olla teräviä.

Käyttötarkoitus

Allied Vision-tuotteen käyttötarkoitus on integrointi kuvajärjestelmiin ammattilaisten toimesta. Kaikki Allied Vision-tuotteet myydään B2B-ympäristössä.

FR - Français

Sécurité

Veillez lire ces consignes de sécurité avant d'utiliser la caméra. Respectez continuellement les avertissements. Utilisez la caméra uniquement comme indiqué sous [Intended use](#), page 39.



ATTENTION

Risque de brûlures

Une caméra en service peut atteindre des niveaux de température susceptibles d'entraîner des brûlures.



ATTENTION

Blessures en cas de chute de caméras ou d'objectifs

La chute d'une caméra ou d'un objectif peut entraîner des blessures.



ATTENTION

Risque de coupures sur les bords tranchants des montures d'objectif

Les filetages des montures d'objectif peuvent présenter des bords tranchants.

Utilisation prévue

L'utilisation prévue du produit Allied Vision est son intégration dans des systèmes de vision par le soin de professionnels. Tout produit Allied Vision est vendu dans un cadre B2B.

עברית - HE

בטיחות

לפני השימוש במצלמה, עליך לקרוא את הוראות הביטחון האלו. עליך לממש הוראות ביטחון אלו תמיד. השימוש במצלמה הוא רק לפי מה שכתוב ב"כוונת השימוש" (Intended use) בעמוד 39.

זהירות

סכנת כווייה

בזמן הפערת המצלמה עלולות טמפרטורות גבוהות לעלות, שיכולות לגרום לכוויות.



זהירות

פגיעה מנפילת מצלמות או עדשות

מצלמה או עדשה שנופלות עלולות לגרום לפגיעה.



זהירות

סכנה להחתך מתבריג חד של העדשה

תבריג תושבת העדשה עלול להיות חד עד כדי פגיעה.



שימוש מיועד

מוצרי AlliedVision מיועדים לשילוב במערכות ממוחשבת לעיבוד צילומים ע"י אנשי מקצוע. כל מוצרי AlliedVision נמכרים לשימוש בסביבת B2B.

IT - Italiano

Sicurezza

Leggere queste istruzioni per la sicurezza prima di utilizzare la telecamera. Osservare sempre tutte le avvertenze. Utilizzare la telecamera come descritto alla sezione [Intended use](#) a pagina 39.



ATTENZIONE

Pericolo di ustioni

Durante il funzionamento una telecamera può raggiungere temperature elevate che possono essere causa di ustioni.



ATTENZIONE

Lesioni dovute alla caduta di telecamere o lenti

La caduta di una telecamera o di una lente può causare delle lesioni.



ATTENZIONE

Pericolo di tagliarsi sui bordi affilati degli attacchi della lente

I bordi della filettatura dell'attacco della lente possono essere affilati.

Usò previsto

Il prodotto Allied Vision è concepito per essere integrato in sistemi di monitoraggio in campo professionale. Tutti i prodotti Allied Vision sono venduti in uno scenario B2B.

JA - 日本語

安全性

本カメラを使用する前に、この安全の手引きをお読みください。常に、警告事項を守ってください。必ず、[Intended use 39](#) ページの通りに、本カメラを使用してください。



注意

やけどの危険性

作動中のカメラは、やけどを引き起こす温度まで熱くなる恐れがあります。



注意

カメラまたはレンズの落下によるけが

カメラまたはレンズが落下すると、けがをする恐れがあります。



注意

レンズマウントの鋭利な端部で切り傷の危険性

レンズマウントのギザギザの部分が鋭利である可能性があります。

用途

Allied Vision製品は、専門家が視覚装置に統合することを意図したものです。すべてのAllied Vision製品は、企業間取り引き用に販売されています。

NL - Nederlands

Veiligheid

Lees deze veiligheidsinstructies voordat u de camera gaat gebruiken. Neem deze waarschuwingen altijd in acht. Gebruik de camera uitsluitend, zoals aangegeven in het [Intended use](#) op pagina 39.



VOORZICHTIG

Risico van verbranding

Een camera die gebruikt wordt, kan temperatuurwaarden bereiken die brandwonden kunnen veroorzaken.



VOORZICHTIG

Letsel door vallende camera's of lenzen

Een vallende camera of lens kan letsel veroorzaken.



VOORZICHTIG

Risico van snijwonden door scherpe randen van lensbevestigingen

Het schroefdraad van de lensbevestiging kan scherpe randen hebben.

Beoogd gebruik

Het beoogde gebruik van het Allied Vision-product is de integratie in optische systemen door professionals. Alle Allied Vision-producten worden verkocht in de B2B-markt.

NO - Norsk

Sikkerhet

Les disse sikkerhetsinstruksene før du bruker kameraet. Følg advarslene til en hver tid. Bruk kun kameraet i samsvar med [Intended use](#) på side 39.



FORSIKTIG

Risiko for brannskader

Et kamera i bruk kan nå temperaturnivåer som kan forårsake brannskader.



FORSIKTIG

Skade ved fallende kameraer eller linser

Et fallende kamera eller en fallende linse kan forårsake skade.



FORSIKTIG

Risiko for kutt fra skarpe kanter på linsefester

Sporene på linsefestet kan ha skarpe kanter.

Tiltenkt bruk

Den tiltenkte bruken av Allied Vision-produktet er integrering i visjonssystemer av profesjonelle. Alle Allied Vision-produkter selges i en forretning til forretning-situasjon.

SV - Svenska

Säkerhet

Läs igenom säkerhetsinstruktionerna innan du använder kameran. Var hela tiden särskilt uppmärksam på varningarna. Använd enbart kameran på det sätt som anges i [Intended use](#) på sida 39.



VARNING

Risk för brännskada

En kamera i drift kan komma upp i temperaturer som kan orsaka brännskador.



VARNING

Risk för skador från fallande kameror eller objektiv

Fallande kameror eller objektiv kan förorsaka skador.



VARNING

Risk för skärsår från vassa kanter på objektivfattningar

Objektivets gängor kan ha vassa kanter.

Avsedd användning

Den avsedda användningen av Allied Vision-produkter är integrering i visionssystem av fackmän. Samtliga Allied Vision-produkter säljs i en B2B-miljö.

ZH - 简体中文版

安全需知

使用本相机前，请阅读本安全说明书。请务必遵守相关警告 和 [Intended use](#) 于第 39 页。



注意事项

烫伤风险

相机操作过程中温度可能上升并导致烫伤风险。



注意事项

相机或者镜头跌落造成伤害

相机或者镜头可能会跌落并造成伤害。



注意事项

镜头接口的锐利边缘划伤风险

镜头接口螺纹边缘可能较为锐利。

预期用途

Allied Vision 产品的预期用途是由专业人士整合到视觉系统中。所有 Allied Vision 的产品均通过 B2B 渠道销售。

Alvium G5/G5X cameras at a glance



Get an overview of Alvium G5/G5X documentation:

Consider for Alvium G5/G5X cameras	16
Shipping contents.....	16
What else do you need?	16
Alvium Pol- using polarization (coming soon)	17

Consider for Alvium G5/G5X cameras

This user guide applies to Alvium G5 models that can be operated in UDP mode, and to Alvium G5X models that can be operated in UDP mode or in TCP mode. The current document version includes Alvium G5X-2050 and G5X-2460 as first models. In a future version of this document, all existing Alvium G5 models will be available as Alvium G5X models.



Firmware version for Alvium G5X models

While Alvium G5 models are supported by the latest firmware version, Alvium G5X models require FW 00.12.00.00611a22. A future common firmware version will support G5 and G5X.

Topic	Details
Camera startup time	Current Alvium G5/G5X cameras have a boot sequence that may take up to 30 seconds. We aim to reduce the startup-time by future updates.
Camera installation	Alvium G5/G5X cameras require different hardware and settings than 1000BASE-T cameras like Mako or Prosilica GT cameras. We suggest you: <ul style="list-style-type: none"> • Build up general knowledge: Tips and tricks to connect 5GBASE-T on page 181. • Set up a quick running test: Installing the camera on page 144. • Find solutions for issues: Troubleshooting common issues on page 197.
Switches	We recommend you to avoid using switches with Alvium G5/G5X cameras. Better use a separate NIC per camera.

Shipping contents

- Alvium G5/G5X camera
- Download Instructions for First Camera Operation document

What else do you need?

This is a selection of helpful downloads:

Download	Link
Alvium Cameras Features Reference	www.alliedvision.com/en/support/technical-documentation/alvium-gige-documentation
Application notes	
Alvium Modular Concept for extended hardware options, such RCG (Removed Cover Glass)	
Vimba X SDK for Windows, Linux, and Linux/ARM, including Vimba X Viewer , Firmware Updater , and Driver Installer for Windows	www.alliedvision.com/en/products/software/vimba-x-sdk

Table 1: Downloads for Alvium G5/G5X cameras (sheet 1 of 2)

Download	Link
Firmware downloads	www.alliedvision.com/en/support/firmware-downloads
STEP files	Find downloads for your Alvium model at www.alliedvision.com/en/camera-selector
Assembling Alvium Cameras from CAD Component (application note)	www.alliedvision.com/en/support/technical-documentation/alvium-gige-documentation
Accessories , such as interface cables and cards, power and I/O cables, power supplies, lenses, and tripod adapters	www.alliedvision.com/en/products/accessories

Table 1: Downloads for Alvium G5/G5X cameras (sheet 2 of 2)

Alvium Pol - using polarization (coming soon)

Alvium polarizer cameras are equipped with Sony IMX Polarsens sensors that support four-directional polarization using filters directly in front of the sensor. With these cameras, you can replace additional polarizer filters on the lens used in typical applications. In many cases, polarizer sensors can adapt easily to setups with varying polarization angles; there is no need to change or rotate optical polarization filters anymore.

You can use polarized light imaging, for example, to reduce reflections or for surface analysis regarding stress and defects. [Figure 1](#) shows how the orientation of the polarization filters affects brightness values for the sub-images:



Figure 1: Polarization angle versus image brightness in sub-images

Current models:

- [Alvium G5-507m/c Pol \(coming soon\)](#) on page 78
- [Alvium G5-508m/c Pol](#) on page 84



Please observe

For first series models, pixel processing has not been adjusted to enable the complete functionality available with non-polarizer models:

- Only raw pixel formats are supported, but no formats for polarizer sensors.
- Features based on pixel processing are available but cannot be used to generate a proper output. For example, color processing, binning, convolution filter, DPC, or FPNC are not supported.



More information

See the Pixel based polarizer application note at www.alliedvision.com/en/support/technical-documentation/alvium-usb-documentation.

Contact us

Website, email

General

www.alliedvision.com/en/contact
info@alliedvision.com

Distribution partners

www.alliedvision.com/en/avt-locations/avt-distributors

Support

www.alliedvision.com/en/support
www.alliedvision.com/en/about-us/contact-us/technical-support-repair-/-rma

Offices

Europe, Middle East, and Africa (Headquarters)

Allied Vision Technologies GmbH
Taschenweg 2a
07646 Stadtroda, Germany
T// +49 36428 677-0 (Reception)
T// +49 36428 677-230 (Sales)
F// +49 36428 677-28

Asia-Pacific

China

Allied Vision Technologies
(Shanghai) Co., Ltd.
2-2109 Hongwell Int. Plaza
1602# ZhongShanXi Road
Shanghai 200235, China
T// +86 21 64861133

Singapore

Allied Vision Technologies Asia Pte. Ltd
82 Playfair Rd, #07-01 D'Lithium
Singapore 368001
T// +65 6634 9027

North, Central, and South America

Canada

Allied Vision Technologies Canada Inc.
300 – 4621 Canada Way
Burnaby, BC V5G 4X8, Canada
T// +1 604 875 8855

USA

Allied Vision Technologies, Inc.
102 Pickering Way- Suite 502
Exton, PA 19341, USA
Toll-free// +1-877-USA-1394
T// +1 978 225 2030

Contents

Read before use	2
EN - English	2
DA - Dansk	3
DE - Deutsch	4
ES - Español	5
FI - Suomi	6
FR - Français	7
HE - עברית	8
IT - Italiano	9
JA - 日本語	10
NL - Nederlands	11
NO - Norsk	12
SV - Svenska	13
ZH - 简体中文版	14
Alvium G5/G5X cameras at a glance	15
Consider for Alvium G5/G5X cameras	16
Shipping contents	16
What else do you need?	16
Alvium Pol - using polarization (coming soon)	17
Contact us	19
Document history and conventions	25
Document history	26
Conventions used in this user guide	33
Typographic styles	33
Symbols and notes	33
Acronyms and terms	34
Compliance, safety, and intended use	36
Camera identification	37
Compliance notifications	37
For customers in the US	37
For customers in Canada	38
Pour utilisateurs au Canada	38
Avoid electromagnetic interferences	38
Intended use	39
Copyright and trademarks	39
Your safety	40
Camera mounting	41
Product safety	42
Electrical connections	42
Optical components	44
Mechanical components	47

Specifications	48
Applied standards	49
GenICam	49
IP class	49
Shock and vibration	49
Notes on specifications	51
Sensor	51
Exposure time and frame rates	52
Triggering and sensor shutter types	54
Brightness with G5-812 UV cameras	56
Digital binning	56
Sensor binning	56
Multiple regions	57
Operation for typical power consumption	60
Dimensions and mass	60
Alvium G5/G5X model specifications	61
Alvium G5-052m/c	61
Alvium G5-130 VSWIR	63
Alvium G5-203m/c	66
Alvium G5-240m/c	68
Alvium G5-291m/c	71
Alvium G5-320 VSWIR (coming soon)	73
Alvium G5-500m/c	75
Alvium G5-507m/c Pol (coming soon)	78
Alvium G5-508m/c	81
Alvium G5-508m/c Pol	84
Alvium G5-510m/c	87
Alvium G5-511m/c	90
Alvium G5-530 VSWIR (coming soon)	93
Alvium G5-811m/c	95
Alvium G5-812 UV	98
Alvium G5-1240m/c	101
Alvium G5-1242m/c	104
Alvium G5-1620m/c	107
Alvium G5-2040m/c	110
Alvium G5/G5X-2050m/c	113
Alvium G5/G5X-2460m/c	117
White balance default	122
Dimensions and mass	123
Technical drawings	123
C-Mount	123
CS-Mount	124
S-Mount	125
Lens mounts and maximum protrusion	126
IR cut filter	127
Sensor position accuracy	128
Sensor shift and rotation	128
Sensor tilt	129

User sets.	130
Supported features.	130
Trigger features and UserSetDefault.	130
Camera feature availability.	131
Lenses: Focal length vs. field of view	133
About this chapter.	134
Parameters in tables.	134
Optical vignetting with certain lenses	134
About S-Mount lenses.	135
Focal length versus field of view	135
Alvium G5-052m/c	135
Alvium G5-130m VSWIR.	136
Alvium G5-203m/c	136
Alvium G5-240m/c	137
Alvium G5-291m/c	137
Alvium G5-320 VSWIR	138
Alvium G5-500m/c	138
Alvium G5-507m/c Pol, -508m/c, -508m/c Pol	139
Alvium G5-510m/c, -511m/c	139
Alvium G5-530 VSWIR	140
Alvium G5-811m/c, -812 UV	140
Alvium G5-1240m/c	141
Alvium G5-1242m/c	141
Alvium G5-1620m/c	142
Alvium G5-2040m/c	142
Alvium G5/G5X-2050m/c.	143
Alvium G5/G5X-2460m/c.	143
Installing the camera	144
Touching hot cameras.	145
Mounting the heat sink.	145
Mounting the camera	146
Bottom or top mounting	146
Front mounting.	147
Adapting maximum torque values	147
Mounting the lens.	148
Mounting and focusing S-Mount lenses.	149
Configuring the host computer	152
Installing the NIC driver	152
IP settings	153
Adjusting the NIC driver settings.	154
Connecting to the host computer	155
Configuring IP settings	155
Powering up the camera.	156
Powering the camera via I/O port.	156
Powering the camera via PoE	156
Software for your Alvium G5	157
Allied Vision software.	157

Third-party software	157
Camera interfaces	158
I/Os: Precautions	159
Back panel	160
I/O connector pin assignment	161
I/Os and GPIOs	162
Isolated input description	162
I/O use for UART	162
Isolated output description	163
Non-isolated GPIOs description	165
Status LEDs	167
LED codes	167
Error state	167
Triggering and timings	168
Trigger signal flow	169
Trigger latency	169
Triggering with rolling shutter cameras	170
Ignored triggers	171
Trigger features and UserSetDefault	171
Image data flow	172
Image data flow diagram	173
FPNC support	174
Firmware update	175
Please note	176
Firmware update with Vimba X	176
Updating the firmware	177
Error handling	179
Performance and troubleshooting	180
Tips and tricks to connect 5GBASE-T	181
Hardware selection	181
NIC hardware installation	182
NIC firmware and drivers	182
NIC driver settings	183
Operation system settings	184
Vimba X TL settings	184
Sharing network bandwidth	188
Optimizing performance	188
Image transfer with rolling shutter cameras	188
Parameter changes	189
Value changes by feature interdependencies	190
Dark current compensation	192
Shutter types affecting image readout	193
DevicePowerSavingMode	194
Operating systems and bandwidth	194

Reference system	195
Feature values	196
Troubleshooting common issues	197
Camera is not powered	197
Camera is not detected in the viewer	197
Camera cannot acquire images	198
Avoiding dropped packets	199
Index	200

Document history and conventions



This chapter includes:

Document history	26
Conventions used in this user guide.....	33
Acronyms and terms	34

Document history

Version	Date	Remarks
V2.0.0	2024-Mar-22	<p>Release: Firmware version: 00.13.01.794391f9 Alvium G5X models require FW 00.12.00.00611a22.</p> <ul style="list-style-type: none"> Added Available subregion resolutions on page 58. Added QE curve for Alvium G5-812 UV on page 98. Added DevicePowerSavingMode on page 194. Applied editorial changes.
V1.9.0	2024-Mar-05	<p>Firmware version: 00.13.00.71d891fe Alvium G5X models require FW 00.12.00.00611a22.</p> <ul style="list-style-type: none"> Added introduction for Alvium Pol- using polarization (coming soon) on page 17. Added contents for manufacturing conditions regarding Sensor cleanliness on page 45. Added a note that the output bit depth affects the minimum available exposure times in Sensor ADC readout modes for maximum frame rates on page 53. Added contents for Brightness with G5-812 UV cameras on page 56. Updated exposure time ranges in Alvium G5/G5X model specifications on page 61 Changed Specifications on page 48 and in Lenses: Focal length vs. field of view on page 133: <ul style="list-style-type: none"> Added models coming soon: Alvium G5-320 VSWIR, -507 Pol, and -530 VSWIR. Updated data for G5-508 Pol (G5-508c Pol is coming soon). Aligned sensor size values to 1 decimal place. Updated contents in IP settings on page 153. Added instructions for Configuring IP settings on page 155. Added a note for Cognex VisionPro in Third-party software on page 157. Extended the name of the camera's I/O connector from TFM-105-02-L-D to TFM-105-02-L-DH in Back panel on page 160. <p>Continued on next page.</p>

Table 2: Document history (sheet 1 of 7)

Version	Date	Remarks
V1.9.0	2024-Mar-05	<p>Firmware version: 00.13.00.71d891fe Alvium G5X models require FW 00.12.00.00611a22.</p> <p>Continued from previous page.</p> <ul style="list-style-type: none"> Added information on FPNC support on page 174 and updated corresponding data in Camera feature availability on page 131. Renamed chapter Frame rate jitter to Parameter changes on page 189 and added contents for stopped streaming. Applied editorial changes.
V1.8.0	2023-Dec-04	<p>Release: Firmware version: 00.13.00.71d891fe Alvium G5X models require FW 00.12.00.00611a22.</p> <ul style="list-style-type: none"> Updated table for Frame rates with rolling shutter sensors on page 55. Extended information on Sensor binning on page 56. Changes to Alvium G5/G5X model specifications on page 61: <ul style="list-style-type: none"> Updated frame rates. Added 2.5GBASE-T mode. Changed width resolution for G5-510 and -511 from 2472 to 2464 pixels. (The width resolution for these models is 2464 with all firmware versions. In earlier versions of this user guide, 2472 pixels were specified incorrectly.) Separated Raw color pixel formats from RGB color pixel formats. Added support for sensor binning for G5-203m, -240m, -291m, -508m, and -508m Pol. Updated Camera feature availability on page 131.
V1.7.0	2023-Nov-07	<p>Firmware version: 00.12.00.00611a22</p> <ul style="list-style-type: none"> Added Alvium G5-508 Pol in Alvium G5/G5X model specifications on page 61 and in Focal length versus field of view on page 135.

Table 2: Document history (sheet 2 of 7)

Version	Date	Remarks
V1.6.1	2023-Oct-26	Firmware version: 00.12.00.00611a22 <ul style="list-style-type: none"> Added data for the South Korean KC Safety Certification in Compliance notifications on page 37. In order to avoid misunderstandings, truncated the name of the camera's I/O connector to TFM-105-02-L-D in Back panel on page 160.
V1.6.0	2023-Sep-27	Firmware version: 00.12.00.00611a22 <ul style="list-style-type: none"> Added G5-203 model in Specifications on page 48 and in Focal length versus field of view on page 135. Reduced minimum operating temperature to -20 °C in Alvium G5/G5X model specifications on page 61. Applied editorial changes.
V1.5.1	2023-Jul-18	Firmware version: 00.12.00.00611a22 Added Alvium G5-240 models in Specifications on page 48 and Focal length versus field of view on page 135.
V1.5.0	2023-Jul-12	Firmware version: 00.12.00.00611a22 <ul style="list-style-type: none"> Renamed the title and contents from Alvium G5 to Alvium G5/G5X to include new G5X models. Updates to Alvium G5/G5X model specifications on page 61: <ul style="list-style-type: none"> Changed horizontal resolution for G5-510 and G5-511. Added G5X-2050 and G5X-2460 as first models supporting TCP mode in addition to standard UDP mode supported by all G5 models. Added Global reset shutter (GRS) to G5-2050 for shutter type.
V1.4.1	2023-Jun-15	Firmware version: 00.12.00.00611a22 <ul style="list-style-type: none"> Updated compliance with GigE Vision standard to V2.2 in Applied standards on page 49. Added 12-bit pixel formats in Alvium G5/G5X model specifications on page 61. Completed contents in Camera feature availability on page 131. Applied editorial changes.

Table 2: Document history (sheet 3 of 7)

Version	Date	Remarks
V1.4.0	2023-Jun-06	<p>Release: Firmware version: 00.12.00.00611a22</p> <ul style="list-style-type: none"> Updated Hebrew contents in Read before use on page 2. Added data on multiple regions and sensor binning for selected models in Alvium G5/G5X model specifications on page 61, in Camera feature availability on page 131, and in Image data flow on page 172. Updated QE curve for G5-130 VSWIR in Alvium G5/G5X model specifications on page 61. Updated maximum resolution values and the according frame rates for Alvium G5-1620m/c on page 107 to 5328 (H) × 3040 (V). Reduced value for sensor shift with G5-2050 models to 150 μm in Sensor position accuracy on page 128. Corrected data in table for I/O use for UART on page 162. Updated contents for Vimba X. Applied editorial changes.
V1.3.0	2023-Jan-17	<p>Firmware version: 00.11.00.9cf0c21e</p> <ul style="list-style-type: none"> Updated values for minimum bandwidth to reach maximum frame rates in Alvium G5/G5X model specifications on page 61. Corrected the width value in the specifications for Alvium G5-1620m/c on page 107. Added Alvium G5-1242 and G5-2040 models in Alvium G5/G5X model specifications on page 61 and Focal length versus field of view on page 135. Reduced contents in Operating systems and bandwidth on page 194. Applied editorial changes.

Table 2: Document history (sheet 4 of 7)

Version	Date	Remarks
V1.2.0	2022-Nov-14	<p>Release: Firmware version: 00.11.00.9cf0c21e</p> <ul style="list-style-type: none"> • Updated the title image. • Added note that lenses are not part of the product. • Updated standard references in Applied standards on page 49. • Added note on deviations from stated frame rates in Operation for maximum frame rates on page 52 • Replaced previous calculated values for ROI frame rates by measured values in Alvium G5/G5X model specifications on page 61. • Added Alvium G5-510 models in Alvium G5/G5X model specifications on page 61 and Focal length versus field of view on page 135. • Changes to Camera feature availability on page 131: <ul style="list-style-type: none"> - Removed Image Chunk Data - Added Sequencer. • Added contents for Ethernet Flow Control to avoid dropped frames in NIC driver settings on page 183. • Updated and restructured contents on the Reference system on page 195. • Applied editorial changes.
V1.1.5	2022-Sep-27	<p>Firmware version: 00.10.00.6c9062b1</p> <p>Removed FPNC availability for G5-052 and G5-291 in Camera feature availability on page 131 and in Image data flow on page 172.</p>
V1.1.4	2022-Sep-20	<p>Firmware version: 00.10.00.6c9062b1</p> <p>Applied editorial changes</p>

Table 2: Document history (sheet 5 of 7)

Version	Date	Remarks
V1.1.3	2022-Sep-19	<p>Firmware version: 00.10.00.6c9062b1</p> <ul style="list-style-type: none"> Added Hebrew contents to Read before use on page 2. Changed units KB to KByte, MB to MByte, and MBps to MByte/s for clarity. Update note for PoE in Product safety on page 42 and removed note for PoE in I/Os: Precautions on page 159. Updates to Alvium G5/G5X model specifications on page 61: <ul style="list-style-type: none"> Adjusted values for bandwidth in Factors for exposure time and frame rates on page 53. Removed data for Alvium G5-030 VSWIR from, also in Focal length versus field of view on page 135. Corrected max. gain for Alvium G5-130 VSWIR to 42 dB. Set all models to Available. <p>Applied editorial changes.</p>
V1.1.2	2022-Aug-05	<p>Firmware version: 00.10.00.6c9062b1</p> <p>Added power consumption values and removed “Coming soon” status for Alvium G5-812 UV on page 98.</p>
V1.1.1	2022-Jul-22	<p>Firmware version: 00.10.00.6c9062b1</p> <p>Added values for minimum and maximum exposure times in Alvium G5/G5X model specifications on page 61.</p>

Table 2: Document history (sheet 6 of 7)

Version	Date	Remarks
V1.1.0	2022-Jul-20	<p>Release: Firmware version: 00.10.00.6c9062b1</p> <ul style="list-style-type: none"> Replaced notes to inquire with Allied Vision Sales representatives by download links to the Allied Vision website. Added Camera identification on page 37, including Model ID for DoC assignment. Updated data in Alvium G5/G5X model specifications on page 61 for: <ul style="list-style-type: none"> ROI frame rates and exposure time ranges Maximum gain for Sony IMX global shutter cameras increased to 48 dB Added G5-052, 291, and -812 UV models in Alvium G5/G5X model specifications on page 61 and Focal length versus field of view on page 135. Added the information that Alvium G5-511 is supplied on request only to Sensor position accuracy on page 128. Added new functionalities to Camera feature availability on page 131. Added warning against voltage levels of serial communication and wrong polarity of external power in I/Os: Precautions on page 159. Added I/O use for UART on page 162. Removed FPNC support for VSWIR models in Image data flow on page 172. Removed the section “Feature value changes on a streaming camera” from Optimizing performance on page 188. Applied editorial changes.
V1.0.2	2022-Apr-22	<p>Firmware version: 00.08.00.6727174b</p> <ul style="list-style-type: none"> Added contents for Alvium G5-511 in Alvium G5/G5X model specifications on page 61 and Focal length versus field of view on page 135. Updated values for Exposure Mode of various models in Alvium G5/G5X model specifications on page 61.
V1.0.1	2022-Mar-28	<p>Firmware version: 00.08.00.6727174b</p> <p>Updated power consumption values for PoE operation in Alvium G5/G5X model specifications on page 61.</p>
V1.0.0	2022-Mar-24	<p>Release: Firmware version: 00.08.00.6727174b</p> <p>Release version</p>

Table 2: Document history (sheet 7 of 7)

Conventions used in this user guide

To give this manual an easily understood layout and to emphasize important information, the following typographical styles and symbols are used.

Typographic styles

Style (example)	Function
Emphasis	Programs, or highlighting important things
Feature names	GenICam features names
<i>Feature options</i>	Features options and register's options that are selectable by the user
UI Element	Text that is displayed, or output, by the system for the user, like parts of the GUI, dialog boxes, buttons, menus, important information, windows titles.
Reference	Links to webpages and internal cross references

Table 3: Typographic styles

Symbols and notes



CAUTION

Risk of burns

Precautions are described



CAUTION

Injury by falling cameras or lenses

Precautions are described



CAUTION

Risk of cuts by sharp edges of lens mounts

Precautions are described



NOTICE

Material damage or violation of data security

Precautions are described.



Practical Tip

Additional information helps to understand or ease handling the camera.

Avoiding malfunctions

Precautions are described.

Additional information

Web link or reference to an external source with more information is shown.

Acronyms and terms

The following table provides a list of acronyms and terms used in this document.

Acronym or term	Description
ADC	Analog to Digital Converter
AIA	Automated Imaging Association
CRA	Chief ray angle
EMVA	European Machine Vision Association
ERS	Electronic rolling shutter also known as “rolling shutter”
ESD	Electrostatic Discharge
FCC	Federal Communications Commission
FOV	Field of view
FPNC	Pixed pattern noise correction
fps	Frames per second
Gbit/s	Gigabit per second
GenICam	Generic Interface for Cameras, EMVA
GND	Ground (power)
GPIOs	General purpose inputs and outputs (non-isolated)
GRRS	Global reset release shutter, see GRS
GRS	Global reset shutter, see GRRS
GS	Global shutter
H × V	Horizontal × Vertical (sensor resolution)
KByte	Kilobyte
MByte	Megabyte
MByte/s	Megabyte per second
MP	Megapixels (see P)
N.a.	Not applicable (in tables)
NIC	Network interface card
P	Pixels (see MP)
PSE	Power sourcing equipment

Table 4: Acronyms and terms (sheet 1 of 2)

Acronym or term	Description
QE	Quantum efficiency
RoHS	Restriction of Hazardous Substances Directive
ROI	Region of interest
RS	Rolling shutter
SFNC	Standard Feature Naming Convention (GenICam)
shutter mode	Value of the ShutterMode feature to select between rolling shutter (RS) and global release shutter (GRS)
shutter type	Sensor specific readout, such as rolling shutter (RS) or global shutter (GS)
S-Mount	M12-Mount
TCP	Transmission Control Protocol
UDP	User Datagram Protocol

Table 4: Acronyms and terms (sheet 2 of 2)

Compliance, safety, and intended use



This chapter includes:

Camera identification.....	37
Compliance notifications	37
Intended use	39
Copyright and trademarks	39
Your safety.....	40
Product safety	42

Camera identification

You can identify your Alvium G5/G5X camera like this:



Closed housing Alvium G5/G5X cameras have the Model ID: **A 1 F**.

The variants of closed housing Alvium G5/G5X cameras (model ID: A 1 F) are **KC certified**.

Compliance notifications



National regulations on disposal must be followed.

For customers in the US



Class B digital device

This equipment has been tested and found to comply with the limits for a Class B digital device, pursuant to part 15 of the FCC Rules. These limits are designed to provide reasonable protection against harmful interference in a residential installation. This equipment generates, uses and can radiate radio frequency energy and, if not installed and used in accordance with the instructions, may cause harmful interference to radio communications. However, there is no guarantee that interference will not occur in a particular installation. If this equipment does cause harmful interference to radio or television reception, which can be determined by turning the equipment off and on, the user is encouraged to try to correct the interference by one or more of the following measures:

- Reorient or relocate the receiving antenna.
- Increase the separation between the equipment and receiver.
- Connect the equipment into an outlet on a circuit different from that to which the receiver is connected.
- Consult the dealer or an experienced radio/TV technician for help.

Supplier Declaration of Conformity

Alvium G5/G5X cameras comply with Part 15 of the FCC Rules. Operation is subject to the following two conditions:

1. This device may not cause harmful interference, and
2. This device must accept any interference received, including interference that may cause undesired operation.

Party issuing Supplier's Declaration of Conformity

Allied Vision Technologies GmbH
Taschenweg 2a
07646 Stadtroda, Germany
T// +49 (36428) 677-106
quality@alliedvision.com

Responsible party - US contact information

Allied Vision Technologies, Inc.
102 Pickering Way – Suite 502
Exton, PA 19341, USA
T// +1 978 225 2030

Note: changes or modifications not expressly approved by the party responsible for compliance could void the user's authority to operate the equipment.

For customers in Canada

This apparatus complies with the Class B limits for radio noise emissions set out in the Radio Interference Regulations.

CAN ICES-3 (B) / NMB-3 (B)

Pour utilisateurs au Canada

Cet appareil est conforme aux normes classe B pour bruits radioélectriques, spécifiées dans le Règlement sur le brouillage radioélectrique.

CAN ICES-3 (B) / NMB-3 (B)

Avoid electromagnetic interferences

Interface cables, power cables, and I/O cables are sensitive to electromagnetic interference.

- Use shielded cables only.
- We recommend using cables offered by Allied Vision.
- Avoid coiling.
- We recommend using GPIOs only in environments with low electromagnetic interference.

Moreover, avoid unnecessary bending to prevent damage to the cables.

Intended use

Allied Vision's objective is the development, design, production, maintenance, servicing and distribution of digital cameras and components for image processing. We are offering standard products as well as customized solutions.

Intended use of Allied Vision product is the integration into Vision systems by professionals. All Allied Vision product is sold in a B2B setting.

Allied Vision isn't a legal manufacturer of medical product. Instead, Allied Vision cameras and accessories may be used as components for medical product after design-in by the medical device manufacturer and based on a quality assurance agreement (QAA) between Allied Vision (supplier) and medical device manufacturer (customer). Allied Vision's duties in that respect are defined by ISO 13485, clause 7.2 (customer-related processes, equivalent to ISO 9001, clause 8.2).

Copyright and trademarks

All text, pictures, and graphics are protected by copyright and other laws protecting intellectual property. All content is subject to change without notice.

All trademarks, logos, and brands cited in this document are property and/or copyright material of their respective owners. Use of these trademarks, logos, and brands does not imply endorsement.

Copyright © 2024 Allied Vision GmbH. All rights reserved.

Your safety

This section informs about issues related to your personal safety. Descriptions explain how to avoid hazards and operate Alvium G5/G5X cameras safely.

Handling lens mounts

The lens mount thread has sharp edges. Be careful these edges do not cut your skin when mounting or unmounting lenses.

Handling hot cameras

Depending on the individual setup, Alvium G5/G5X cameras can exceed the specified maximum operating temperature. In many cases, mounting the camera on a metal surface or using a lens will be sufficient to cool the camera effectively. However, especially when operated in higher ambient temperatures, additional measures for heat dissipation, such as using a heat sink, should be considered.

If you have doubts or questions, please feel free to contact your Allied Vision Sales representative for support!

If the mainboard temperature exceeds the specified maximum for more than two seconds, the camera is powered off automatically. The current value for mainboard temperature is output by `DeviceTemperature`. You can use this value to control cooling by software, for example, to control a fan.

However, if you hold the camera in your hands during operation, your skin may get hurt. If you touch the camera when it is heated up, we recommend wearing protective gloves.

Providing optimum heat dissipation

Keep the operating temperature in the specified range to enable best image quality and to protect the camera from damage.

For your safety and to improve image quality, operate the camera:

- Mounted to a base with a high thermal conductivity
- With lens or other optical components mounted
- With heat sinks mounted that have large surface areas (see note below)
- Using conductive media for camera and heat sink mounting
- With active cooling of camera, mounting base, and heat sink, such as by ventilation.
- Reduce high ambient temperature. For example, in outdoor applications with direct sunlight, provide shading by an enclosure.



Heat dissipation

For a suitable heat sink, see www.alliedvision.com/en/support/accessory-documentation.

For more information on heat dissipation, see the Optimum Heat Dissipation for Alvium G5/G5X Cameras application note: www.alliedvision.com/en/support/technical-documentation/alvium-gige-documentation.

Camera mounting

Cameras must be mounted using the mounting threads. If vibration is higher than specified, cameras can disconnect from the mounting. Falling cameras can hurt you. To avoid personal injury:

- Mount the camera according to the instructions in [Mounting the camera](#) on page 146.
- Ensure, shock and vibration do not exceed the specified range, see [Shock and vibration](#) on page 49.
- Use all 3 mounting threads on the bottom of the camera for dynamic applications with high acceleration.
- Use a lens support if you want to use [Heavy lenses](#).

Heavy lenses

For non-static applications, use lenses with a mass less than 140 grams and a length less than 38 mm, where the center of gravity is 20 mm, measured from the lens mount front flange. For heavier or longer lenses, use a lens support and apply additional tests. For more information, please contact support at www.alliedvision.com/en/about-us/contact-us/technical-support-repair/-rma.



Applied mechanical tests

See [Shock and vibration](#) on page 49 for standards compliance.

Product safety

To prevent material damage, read the following and understand how to safely handle and operate the camera. Get helpful details about electrical connections and learn how to optimize camera performance.

Electrical connections

ESD

ESD is dangerous for electronic devices, especially when tools or hands get in contact with connectors and electronic components. We recommend measures to avoid damage by ESD:

- **Unpacking:** Remove the camera from its anti-static packaging only when your body is grounded.
- **Workplace:** Use a static-safe workplace with static-dissipative mat and air ionization.
- **Wrist strap:** Wear a static-dissipative wrist strap to ground your body.
- **Clothing:** Wear ESD clothing. Keep components away from your body and clothing. Even if you are wearing a wrist strap, your body is grounded but your clothes are not.

Cable connections

Provide sufficient strain relief for all cable connections to avoid short circuits and malfunctions.

Camera power

Operating the camera beyond the specified range damages the camera.

Cameras can be powered using the I/O connector at an input range of 12 to 24 VDC, using a limited power source (LPS), according to IEC 62368-1 with minimum 2.0 A. The camera is not intended to be connected to a DC distribution network.

Alternatively, cameras can be powered over Ethernet. However, power consumption and heat generation are higher than with external power, using the I/O connector.

- Make sure that PoE power sourcing equipment is at least compliant to IEEE 802.3af.
- Only use power supplies that meet the insulation requirement according to PELV or SELV. For details, please refer to IEC 61140.
- If using external power supplies by third-party manufacturers, observe polarity to avoid damage to the camera electronics.



PoE versus external power

Powering the camera via PoE results in higher power consumption and heat generation than external power, resulting in higher energy costs and requiring more efficient heat dissipation.



External power supply

For an external power supply, see www.alliedvision.com/en/support/accessory-documentation.

PoE Power Sourcing Equipment (PSE)

Damage to the camera or connected peripherals can occur if PSE is not galvanically isolated from mains and other electrical connections towards the camera (other than Ethernet signals and shield ground).

To avoid damage

- Only use IEEE802.3af/at compliant PSE equipment to power the camera via PoE.
- Ensure the PSE is galvanically isolated from mains and all other electrical connections towards the camera.

I/Os

To avoid damage to the camera, keep the maximum values for

- Isolated I/Os: Input voltage below 24 VDC, output current below 20 mA per output.
- Non-isolated GPIOs: Input voltage below 5.5 VDC, output current below 12 mA.

See [Alvium G5/G5X model specifications](#) on page 61 for details. The maximum length for I/O cables must not exceed 30 meters.



Power supply via I/O cables

If you power the camera via an I/O cable, consider the voltage drop to meet the minimum supply voltage for the camera.

5GBASE-T connection

5GBASE-T NICs

To avoid damage to 5GBASE-T NICs and injectors, make sure that PoE power sourcing equipment is at least compliant to IEEE 802.3af.



5GBASE-T accessories

For Accessories, such as interface cables and cards, see www.alliedvision.com/en/support/accessory-documentation.

Ethernet cables

Proper cable handling enables reliable performance:

- Use Category 6 cables or higher rated Ethernet cables: Cat6 is sufficient for up to 55 m, we recommend using Cat7 especially when 100 m are exceeded.
- Use only shielded cables to avoid electromagnetic interferences.
- Please use cables recommended by Allied Vision.
- Avoid unnecessary bending to prevent damage to the cables.
- Avoid coiling to prevent electromagnetic interference.

Optical components

Provide the following conditions to keep dirt and droplets out of the optical system of camera and lens:

- Dust-free environment
- Low relative humidity
- No condensation.

When camera or lens are stored:

- Cover the lens mount with a protection foil or cap.
- Cover front and back lens with caps.

Sensor

Sensors are sensitive to excessive radiation: focused sunlight, UV light, lasers, and X-rays can damage the sensor. Dirt and scratches can damage the sensor as well. Alvium G5/G5X cameras do not need additional cleaning. Cameras are cleaned before shipping. Incorrect cleaning can damage the sensor or the filter. Therefore, never clean the sensor or the filter.

Protect the camera filter and the sensor from dirt, because dirt becomes more visible the closer it gets to the sensor. In addition, keep the back lens clean.

Hold the camera with the lens mount facing the ground to keep dirt out of the lens mount. When no lens is mounted, protect the sensor and filter by a dust cap.

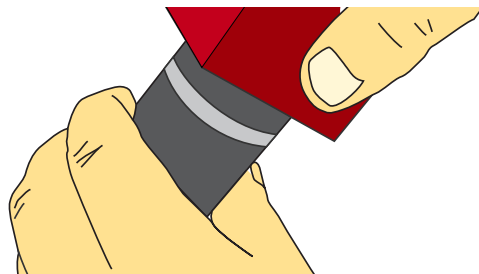

Figure 2: Holding the camera with the lens mount facing the ground

Sensor cleanliness

Definitions for Alvim cameras are shown in <blue>Table 5:

Sensor family	Aperture*	Visible particles quantity	Max. cluster size	Max. cluster quantity
			Pixels at f1/8.0	At f1/8.0
ON Semi	f1/4.0	0	30	2
Sony	f1/8.0	0	0	0

* The incident beam (not related to the lens' angle of view) is $\geq 7^\circ$ for f1/8.0 and $\geq 14^\circ$ for f1/4.0.

Table 5: Sensor cleanliness definitions

Alvim cameras are manufactured to match the requirements of typical machine vision applications. This enables a clean image for typical monitor view. Particles may become visible when the image is viewed critically, such as with contrast enhancement or edge detection.



Advanced sensor cleanliness

If standard definitions for Alvim do not fulfill the requirements of your application, please contact your Allied Vision Sales representative or visit www.alliedvision.com/en/about-us/contact-us/technical-support-repair-/rma.

Lenses

Maximum protrusion

The sensor, filter, or lens can be damaged if a lens exceeding maximum protrusion is mounted to the camera. Use lenses with a maximum protrusion within camera specifications. Figure 3 shows schematics for maximum protrusion. For details, see [Lens mounts and maximum protrusion](#) on page 126.

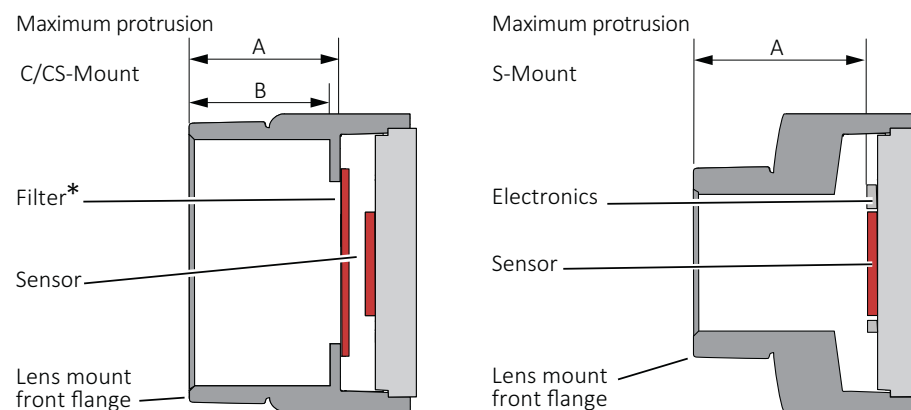

*Only color models are equipped with an IR cut filter

Figure 3: Maximum protrusion C-Mount/CS-Mount and S-Mount

For S-Mount lenses, read [Mounting and focusing S-Mount lenses](#) on page 149 to avoid damage to the sensor, the electronics, and lens.

Mechanical components

Heat sinks

Heat sinks can be used to cool the camera for safety and to improve image quality. Adhere to the instructions provided by the manufacturer of the heat sink.

Conductive media

Some conductive media for heat sinks contain corrosive substances that can damage optical surfaces of the sensor, filter, and lens.

- Cover the optical path of the camera when you apply heat sink compound or adhesive to prevent substances and fumes from damaging optical surfaces.
- Adhere to the instructions and safety notes provided by the manufacturer of the conductive media.
- Ensure that the conductive media is correctly positioned: covering only the components to be cooled.

Specifications



This chapter includes:

Applied standards	49
Notes on specifications	51
Alvium G5/G5X model specifications	61
White balance default	122
Dimensions and mass	123
Technical drawings	123
Lens mounts and maximum protrusion	126
IR cut filter	127
Sensor position accuracy	128
User sets	130
Camera feature availability	131

Applied standards

GenICam

GenICam provides a generic access to cameras and devices that is independent of the interface. This enables operating cameras with USB3 Vision, GigE Vision, or CoaXPress interfaces with a common software.

GenICam consists of multiple modules for different tasks. Allied Vision cameras and software use these modules, such as the SFNC that standardizes feature names and types via an XML file.

Alvium G5/G5X cameras comply to:

- GigE Vision Standard Version 2.2
- GenICam Standard Document Version 2.1.1
- GenAPI Schema Version 1.1
- GenAPI Version 3.1
- GenICam Standard Features Naming Convention (SFNC) Version 2.7
- GenICam Pixel Format Naming Convention (PFNC) Version 2.2

GigE Vision

The GigE Vision standard specifies a **UDP based protocol** for machine vision and imaging products. It provides control over compliant devices by GenICam Applications Programming Interface (API). The GigE Vision standard is administered by the Automated Imaging Association (AIA).

Alvium G5X cameras add TCP based operation, using GigE Vision standard extended by a **custom TCP protocol**.

IP class

Equipped with a lens as intended, Alvium G5/G5X cameras comply with IP40 class according to IEC 60529.

Shock and vibration

Alvium G5/G5X cameras were tested successfully according to the following standards:

- IEC 60068-2-6, sinusoidal vibration testing
- IEC 60068-2-27, shock testing
- IEC 60068-2-64, random vibration testing.

Cameras were inspected before and after the tests. All tests were passed successfully:

Condition	Passed
Mechanics	<ul style="list-style-type: none"> The camera housings showed no deformations. The connections between camera components had not come loose. The sensor position was within the specified tolerances of a new camera.
Camera behavior	Camera functionalities were not affected, no deviations occurred.
Image streaming	Images were streamed without errors.

Table 6: Conditions for passed tests

The conditions for cameras and lenses were the same for all tests. Solid aluminum tubes were used to represent real lenses:

Parameter	Value
Lens dummy length	38 mm
Lens dummy mass	140 g
Center of gravity (CoG) ¹	20 mm

¹For camera and lens dummy assemblies, measured from the lens mount front flange

Table 7: Conditions for lenses

IEC 60068-2-6: Sinusoidal vibration

Frequency	Acceleration	Displacement
10 Hz to 58.1 Hz	Not applicable	1.5 mm
58.1 Hz to 500 Hz	20 g	Not applicable

Table 8: Frequency, acceleration, and displacement for IEC 60068-2-6 tests

Parameter	Value
Axis ¹	x, y, z
Sweep rate	1 oct/min
Sweep duration per axis [hh:mm:ss]	03:45:40
Number of sweeps	10

¹For technical reasons, all three axes are tested with the shaker in the upright position without a sliding table.

Table 9: Other parameters for IEC 60068-2-6 tests

IEC 60068-2-27: Shock

Parameter	Value
Axis	x, y, z
Acceleration	20 g
Number of shocks per axis	10
Duration per axis	11 ms
Waveform	Half sine

Table 10: Parameters for IEC 60068-2-27 tests

IEC 60068-2-64: Random vibration

Frequency	Acceleration
15 Hz to 500 Hz	0.05 g ² /Hz

Table 11: Frequency and acceleration for IEC 60068-2-64 tests

Parameter	Value
Axis	x, y, z
Acceleration RMS (Sigma)	4.9 g
Acceleration peak (Sigma)	14.8 g
Duration per axis [hh:mm:ss]	00:30:00

Table 12: Other parameters for IEC 60068-2-64 tests

Notes on specifications

This section defines the conditions for specifications stated in this chapter.

Sensor

Absolute QE plots

Measurements for color cameras were done with IR cut filter. Measurements for monochrome and S-Mount cameras were done without optical filters. With protection glass or filters, QE decreases by approximately 10 percent.

The uncertainty in measurement of the QE values is ± 10 percent. This is mainly due to uncertainties in the measuring apparatus itself (such as Ulbricht sphere and optometer).

Manufacturing tolerance of the sensor increases overall uncertainty.

ON Semiconductor sensors

The curve in the absolute QE plots shown in this chapter is taken from the sensor manufacturer data sheet. The information was correct at the time of publishing.

Sony sensors

Sony provides relative response curves in their sensor data sheets. To create the absolute QE plots shown in this chapter, the relative response was converted to a normalized QE response and then adjusted as per three measured QE values (at 448 nm, 529 nm, 632 nm) for color sensors and one measured QE value (at 529 nm) for monochrome sensors.

Wavelength

The wavelength range in the absolute QE plots reflects the information available in the sensor manufacturer data sheet at the time of publishing. Many color sensors are documented by the sensor manufacturer only for wavelengths from 400 nm to 700 nm.

Spectral response plots

The curves in the spectral response plots shown in this chapter were calculated from measured quantum efficiencies at 448 nm, 529 nm, and 632 nm. The shape of the curve is taken from the sensor data sheet, but the values have been adjusted based on these measured values. The uncertainty in measurement of the spectral response values is ± 10 percent.

Exposure time and frame rates



Exposure time values

Values for exposure time ranges were measured with FW V00.12.00.00611a22. Minimum exposure times with FW V00.13.00.71d891fe have been reduced for all Alvium G5/G5X models, except for Alvium G5-500, G5-1240, and G5/G5X-2050. Measurements will be published in a future version of this document.

Specified values

Stated values were calculated (see [Operation for maximum frame rates](#)), then verified with the [Reference system](#) on page 195.

Operation for maximum frame rates

Values for maximum frame rates and for minimum and maximum exposure time in the specification tables were measured, based on following parameters:

- Factory settings (camera after power up)
- Minimum exposure time
- Full resolution
- Mono8 pixel format or 8-Bit Bayer pixel format
- Camera operation in freerun mode

- Minimum value for `SensorBitDepth` (8-bit sensor ADC readout mode if available)
- Bandwidth required for the corresponding frame rate, as stated in the tables for ROI frame rates.

Bandwidth: Values were measured for 300 MByte/s, 400 MByte/s, 525 MByte/s.

Bit depth: Values are measured for Mono8. If you are using color formats or 10-bit or 12-bit pixel formats, frame rates fall below values for Mono8.

If `DeviceLinkThroughputLimit` is enabled, you can increase the `DeviceLinkThroughputLimit` value to increase maximum frame rates.

Triggering: See [Frame rates with rolling shutter sensors](#) on page 55

Deviations from stated frame rates can occur, especially when:

- The camera is operated in triggered mode
- Low bandwidth is used
- Small ROIs are used.

Factors for exposure time and frame rates

- The **default bandwidth** for Alvim G5/G5X cameras is 625 MByte/s, the available maximum. `DeviceLinkThroughputLimit` has a default value of 115 MByte/s, but it is disabled. See [Operating systems and bandwidth](#) on page 194.
- Available values and increments for **exposure time** depend on other controls, such as `DeviceLinkThroughputLimit`. See [Value changes by feature interdependencies](#) on page 190.
- For **delays**, see [Exposure start delay = exposure area – exposure time](#). on page 170.
- Calculation of maximum **frame rates for different ROIs** for Alvim G5/G5X cameras does not allow to give a formula. [Operation for maximum frame rates](#) on page 52 defines the conditions for measuring ROI frame rates.

Sensor ADC readout modes for maximum frame rates

If you are using pixel formats that do not require 12-bit sensor ADC readout and you want to achieve higher frame rates, you can select between readout modes for 12-bit, 10-bit, and 8-bit with some Alvim G5/G5X camera models. See your model's specifications.

By default, Alvim G5/G5X models use the maximum bit depth for `SensorBitDepth`. For selected models, *Adaptive* mode switches automatically between 12-bit and 10-bit sensor ADC readout, depending on the selected pixel format's bit depth. This allows to reduce bandwidth and increase frame rates when only 10-bit is required.

To enable the 8-bit sensor readout mode, you must switch manually, using `SensorBitDepth`. Please observe that the image brightness changes when you switch between 8-bit sensor ADC readout mode and the other readout modes.

Keep in mind that changing the output bit depth of the sensor also affects the minimum available exposure time of the camera.

Exposure time behavior regarding ExposureMode

This section informs about how exposure time behaves in the different exposure modes.

All Alvim cameras have an exposure time offset. The exposure time offset and the exposure time increment depend on sensor and camera characteristics. Both, the exposure time offset and the exposure time increment, can change if **Width**, **PixelFormat**, or **DeviceLinkThroughputLimit** are changed. See [Value changes by feature interdependencies](#) on page 190.

ExposureMode = Timed

For all Alvim cameras, exposure time can be set by **ExposureTime** or **ExposureAuto**. For this, **ExposureMode** is set to *Timed*.

The selected exposure time is extended automatically:

- If the selected exposure time does not match the available increment, the camera automatically extends the exposure time to the next increment.
- The **exposure time offset is included** in the selected exposure time.

ExposureMode = TriggerWidth or TriggerControlled

In addition, most global shutter (GS) cameras can control exposure time by the trigger signal, with the **ExposureMode** set to *TriggerWidth* or *TriggerControlled* (using *ExposureStart* and *ExposureStop*).

The trigger controlled exposure time is extended automatically:

- If the trigger controlled exposure time does not match the available increment, the camera automatically extends the exposure time to the next increment.
- Subsequently, the **exposure time offset is added**.

You can use *ExposureActive* to determine the duration of the exposure time offset.

Triggering and sensor shutter types

Triggering behavior differs between cameras with global shutter (GS) and electronic rolling shutter (ERS).

Frame rates with rolling shutter sensors

The following table shows how the shutter mode impacts available frame rates. Reducing the area for ROI reduces readout time. The values in [Table 13](#) apply only if exposure time is shorter than readout time.

Sensor type	Shutter mode	Trigger mode	Frame rates at full resolution*	ROI frame rates
All models, except for...	Global shutter (GS)	Freerun	100%	Increased values
	Global shutter (GS)	External trigger	100%	
G5-500	Rolling shutter (RS)	Freerun	100%	Increased values
	Rolling shutter (RS)	External trigger	>50%	
G5-1240	Rolling shutter (RS)	Freerun	100%	No increase
	Rolling shutter (RS)	External trigger	>99%	
	Global reset shutter (GRS)	Freerun	>99%	
	Global reset shutter (GRS)	External trigger	>99%	
G5/G5X-2050	Rolling shutter (RS)	Freerun	100%	Increased values
	Rolling shutter (RS)	External trigger	>99%	
	Global reset shutter (GRS)	Freerun	>99%	
	Global reset shutter (GRS)	External trigger	>99%	

*Related to the values for maximum frame rates stated in the specification tables for each model.

Table 13: Frame rates depending on shutter modes and trigger modes



Achieved frame rates may not match specified values

- Some sensors have an exposure start jitter that may reduce maximum frame rates.
- Your individual setup may cause delays in data transmission.



Bandwidth adjustments

Consider the bandwidth available for camera payload depends on your individual hardware, the operating system, software and drivers, and your application. We recommend you to adjust `DeviceLinkThroughputLimit` to your requirements.



Interdependencies between ROI and ExposureTime values

Changing parameters for ROI can affect values for `ExposureTime`, such as minimum, maximum, and increments, but `ExposureTime` itself as well. We recommend you to set:

- ROI values
- `DeviceLinkThroughputLimit` before you set values for `ExposureTime`.

See [Value changes by feature interdependencies](#) on page 190 for details.

Brightness with G5-812 UV cameras

When the sensor is exposed to light above 400 nm wavelength, the PLS (parasitic light sensitivity) effect occurs: The brightness level increases from the bottom to the top of the image.

Digital binning

Alvium G5/G5X cameras combine digital horizontal binning and digital vertical binning, for integer values 1 to 8.



Alvium G5/G5X models ≥ 12 MP resolution

If digital horizontal and digital vertical binning are set to 1x and the digital vertical binning value is increased, digital horizontal binning is automatically set to 2x.

Sensor binning

Selected camera models support sensor binning in addition to digital binning. From these models, all support *Sum* for binning, some also support *Average*. See the specifications tables in [Alvium G5/G5X model specifications](#) on page 61.



Please observe

- Only digital binning or sensor binning can be used at a time.
- You must revert binning values to **1** before you can switch between these binning modes.

Multiple regions

All Alvium G5/G5X models support single ROI (region of interest). Because multiple ROI (**MultipleRegions** features) are sensor based, it is not supported by all camera models. With all the corresponding models, *Free* mode is available for **MultipleRegionArrangement** with 1 to 4 subregions. Other models also support *Tile* mode, some models also support *Horizontal* and *Vertical* mode with 1 to 4 subregions. See [Table 14](#).





Mode	Sensor input	Camera output
<i>Free</i>		
<i>Tile</i>		
<i>Horizontal</i>		
<i>Vertical</i>		

Table 14: Modes for MultipleRegions

See the specifications tables in [Alvium G5/G5X model specifications](#) on page 61 for **MultipleRegionArrangement** options and [Available subregion resolutions](#) on page 58.

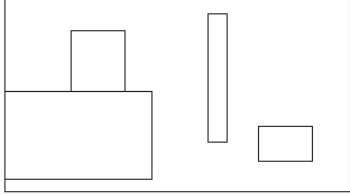

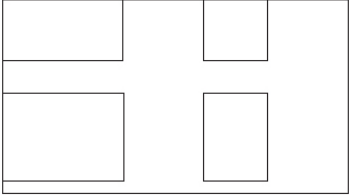
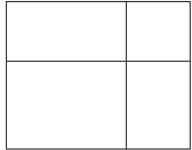
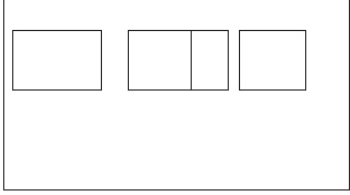
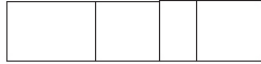
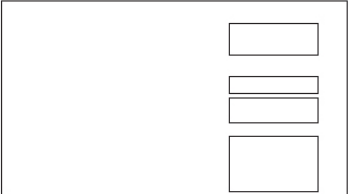
Using multiple regions

Alvium Features Reference: www.alliedvision.com/en/support/technical-documentation/alvium-gige-documentation.

Available subregion resolutions

Table 15 shows the available total pixel resolutions when multiple regions are enabled. How are these values applied?

Alvium G5-2460 supports 1 to 4 subregions in *Horizontal* mode.

Example

Subregions could be 608×8 , 608×8 , 2048×8 , and 1920×8 , with a minimum width of 608 pixels per subregion and a minimum height of 8 pixels.



Minimum width for subregions

We are working on a future solution to enable smaller width values.

The same working principle applies to *Vertical* mode correspondingly.

Alvium model	Sensor	Minimum subregion	Maximum subregion
G5-052	IMX426	Not supported	
G5-130 VSWIR	IMX990	8×8	1296×1032
G5-203	IMX422	16×8	1632×1248
G5-240	IMX392	260×4	1936×1216
G5-320 VSWIR	IMX993	16×8	2080×1544
G5-500	AR0521	Not supported	
G5-507 Pol	IMX264	260×4	2464×2056
G5-508 ¹	IMX250	260×4	2464×2056
G5-510	IMX548	608×8	2464×2064
G5-511	IMX547	608×8	2464×2064
G5-530 VSWIR	IMX992	16×8	2592×2056
G5-811	IMX546	608×8	2848×2848
G5-812 UV	IMX487	608×16	2848×2848
G5-1240	IMX226	Not supported	
G5-1242	IMX545	608×8	4128×3008
G5-1620	IMX542	608×8	5328×3040
G5-2040	IMX541	608×8	4512×4512
G5/G5X-2050	IMX183	Not supported	

Table 15: Available subregion resolutions (sheet 1 of 2)

Alvium model	Sensor	Minimum subregion	Maximum subregion
G5/G5X-2460	IMX540	608 × 8	5328 × 4608
¹ Including PoI models			

Table 15: Available subregion resolutions (sheet 2 of 2)

Operation for typical power consumption

Values for power consumption in the specification tables are based on following parameters:

- Factory settings (camera after power up)
- Minimum exposure time
- Maximum frame rate
- Full resolution
- Mono8 pixel format or 8-Bit Bayer pixel format
- Camera operation in freerun mode
- Sensor ADC readout using maximum bit depth
- Without bandwidth limitations.

Dimensions and mass

For your model's dimensions, see [Dimensions and mass](#) on page 123. For technical drawings, see [Technical drawings](#) on page 123.

Alvium G5/G5X model specifications

Alvium G5-052m/c

Feature	Specification	
	G5-052m	G5-052c
Sensor model	Sony IMX426	
Resolution	816 (H) × 624 (V); 0.5 MP	
Sensor type	CMOS	
Shutter type	Global shutter (GS)	
Sensor size	Type 1/1.7; 7.3 mm × 5.6 mm; 9.2 mm diagonal	
Pixel size	9.0 μm × 9.0 μm	
CRA	0 deg	
Sensor bit depth (ADC)	8-bit, 10-bit, 12-bit; Adaptive (10-bit, 12-bit)	
Monochrome pixel formats	Mono8 (default), Mono10, Mono10p, Mono12, Mono12p, Mono12Packed	Mono8, Mono10, Mono10p, Mono12, Mono12p, Mono12Packed
YUV color pixel formats	Not applicable	YCbCr411_8_CbYYCrYY, YCbCr422_8_CbYCrY, YCbCr8_CbYCr
RGB color pixel formats	Not applicable	BGR8, RGB8 (default)
Raw color pixel formats	Not applicable	BayerRG8, BayerRG10, BayerRG10p, BayerRG12, BayerRG12p, BayerRG12Packed
Maximum frame rate	687 fps (at ≥400 MByte/s)	
Exposure time	24 μs to 10 s (400 MByte/s)	
Exposure modes	Timed, TriggerControlled, TriggerWidth	
Gain	0 dB to 48 dB; 0.1 dB increments	
Digital binning	Horizontal: 1 to 8 columns; Vertical: 1 to 8 rows	
Multiple ROI (H × V)	Free Tile Horizontal: 1 × 1 to 1 × 4 Vertical: 1 × 1 to 4 × 1	
Image buffer (RAM)	512 MByte	
Non-volatile memory (Flash)	1024 KByte	
Inputs and outputs	1 opto-isolated input, 1 opto-isolated output, 2 non-isolated GPIOs	
Power requirements	12 to 24 VDC	
Power requirements (PoE)	IEEE 802.3af	
Power consumption (typical)	External power: 6.6 W at 12 VDC Power over Ethernet: 7.2 W	
Storage temperature	-20 °C to +85 °C ambient temperature	
Operating temperature	-20 °C to +60 °C (Housing), -20 °C to +85 °C (Mainboard ¹)	
Humidity	0% to 80% humidity (non-condensing)	
Digital interface	5GBASE-T, 2.5GBASE-T, 1000BASE-T	
Camera controls	GenICam (GenICam Access)	

¹ Output by DeviceTemperature

Table 16: Alvium G5-052m/c specifications

Absolute QE, spectral response

We intend to add diagrams in a future version of this document.

ROI frame rates

Values are based on the conditions defined in [Specified values](#) on page 52. To reach the maximum frame rate available for typical operation, the bandwidth for image traffic is 400 MByte/s. Increasing the `DeviceLinkThroughputLimit` value does not increase frame rates.

Image format	Width [pixels]	Height [pixels]	ROI area [MP]	Frame rate [fps] ¹		
				525 MByte/s	400 MByte/s	300MByte/s
Full resolution	816	624	0.509	687.6/406.6/413.7	687.6/382.5/382.8	573.5/287.0/286.9
SVGA	800	600	0.48	702.6/424.2/433.6	702.6/406.1/406.1	608.6/304.5/304.4
VGA	640	480	0.307	850.4/632.0/619.7		850.4/475.5/475.7
HVGA	480	320	0.154	1151.8/953.4/848.1		1151.8/949.4/848.1
QVGA	320	240	0.077	1410.7/1171.9/1050.9		
HQVGA	240	160	0.038	1801.8/1495.0/1361.7		
QQVGA	160	120	0.019	2037.1/1698.1/1559.3		
Max. × half	816	312	0.255	1116.5/668.0/685.3		1116.5/573.4/573.8
Max. × min.	816	8	0.007	2951.1/1869.6/ 1995.6	2951.1/1869.5/1995.6	
Min. × max.	8	624	0.005	721.2/596.8/524.7		
Min. × min.	8	8	64 P	3664.1/3082.2/2997.8		

¹ Mono8 or Bayer...8⁽²⁾ at `SensorBitDepth` = 8-Bit⁽³⁾ /
 Mono10 or Bayer...10 at `SensorBitDepth` = 10-Bit /
 Mono12 or Bayer...12 at `SensorBitDepth` = 12-Bit

² The three dots... represent the colors of a Bayer pixel format, such as in BayerRG8.

³ The `SensorBitDepth` value must be set separately from `PixelFormat`.
 See [Sensor ADC readout modes for maximum frame rates](#) on page 53 for details.

Table 17: Alvium G5-052m/c ROI frame rates

Alvium G5-130 VSWIR

Feature	Specification
	G5-130 VSWIR
Sensor model	Sony IMX990
Resolution	1296 (H) × 1032 (V); 1.3 MP
Sensor type	InGaAs
Shutter type	Global shutter (GS)
Sensor size	Type 1/2; 6.4 mm × 5.1 mm; 8.2 mm diagonal
Pixel size	5 μm × 5 μm
CRA	0 deg
Sensor bit depth (ADC)	8-bit, 10-bit, 12-bit; Adaptive (10-bit, 12-bit)
Monochrome pixel formats	Mono8 (default), Mono10, Mono10p, Mono12, Mono12p, Mono12Packed
YUV color pixel formats	Not applicable
RGB color pixel formats	Not applicable
Maximum frame rate	130 fps (at ≥300 MByte/s)
Exposure time	15 μs to 10 s (300 MByte/s)
Exposure modes	Timed, TriggerControlled, TriggerWidth
Gain	0 dB to 42 dB; 0.1 dB increments
Digital binning	Horizontal: 1 to 8 columns; Vertical: 1 to 8 rows
Multiple ROI (H × V)	<i>Free Tile Horizontal: 1 × 1 to 1 × 4 Vertical: 1 × 1 to 4 × 1</i>
Image buffer (RAM)	512 MByte
Non-volatile memory (Flash)	1024 KByte
Inputs and outputs	1 opto-isolated input, 1 opto-isolated output, 2 non-isolated GPIOs
Power requirements	12 to 24 VDC
Power requirements (PoE)	IEEE 802.3af
Power consumption (typical)	External power: 4.9 W at 12 VDC Power over Ethernet: 5.7 W
Storage temperature	-20 °C to +85 °C ambient temperature
Operating temperature	-20 °C to +60 °C (Housing), -20 °C to +85 °C (Mainboard ¹)
Humidity	0% to 80% humidity (non-condensing)
Digital interface	5GBASE-T, 2.5GBASE-T, 1000BASE-T
Camera controls	GenICam (GenICam Access)
¹ Output by DeviceTemperature	

Table 18: Alvium G5-130 VSWIR specifications

Absolute QE

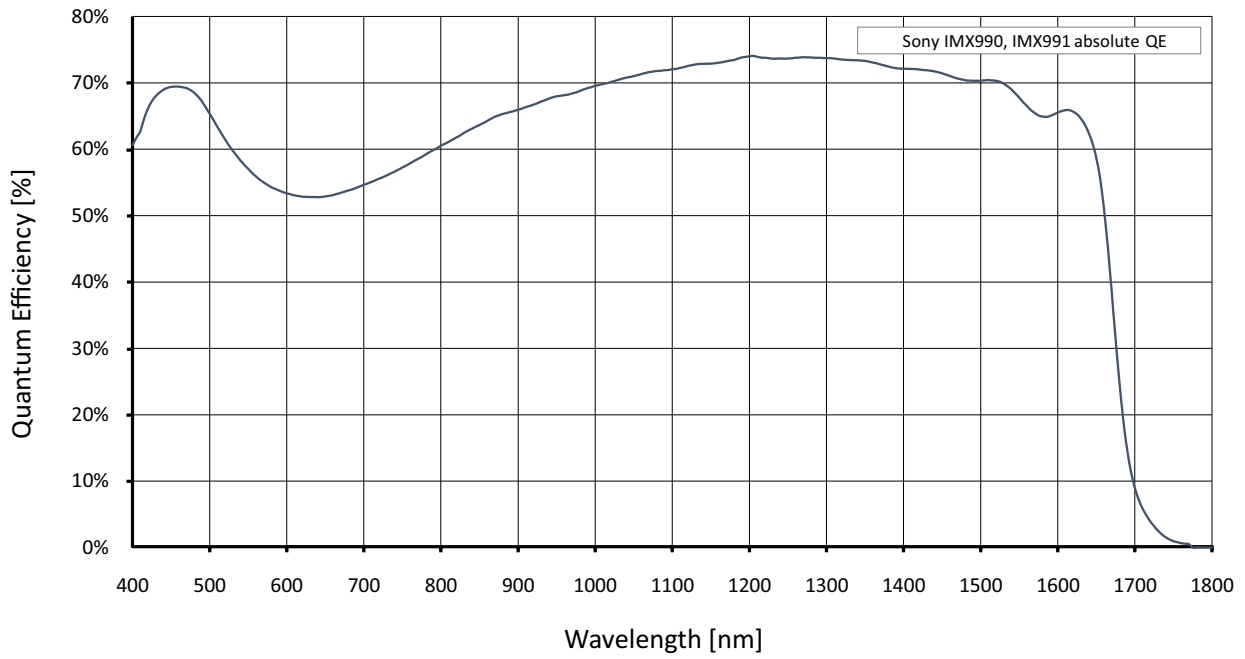

Figure 4: Alvium G5-130m SWIR (Sony IMX990) absolute QE

ROI frame rates

Values are based on the conditions defined in [Specified values](#) on page 52. To reach the maximum frame rate available for typical operation, the bandwidth for image traffic is 300 MByte/s. Increasing the `DeviceLinkThroughputLimit` value does not increase frame rates.

Image format	Width [pixels]	Height [pixels]	ROI area [MP]	Frame rate [fps] ¹		
				525 MByte/s	400 MByte/s	300MByte/s
Full resolution	1296	1032	1.337	130.8/121.2/69.7		130.8/109.3/69.7
SXGA	1280	1024	1.311	131.8/122.1/70.3		131.8/111.5/70.3
HD 720	1280	720	0.922	183.3/169.5/97.7		183.3/158.6/97.7
XGA	1024	768	0.786	173.1/160.5/92.4		
SVGA	800	600	0.48	218.3/202.1/116.3		
VGA	640	480	0.307	267.9/248.3/143.0		
HVGA	480	320	0.154	384.9/356.4/205.2		
QVGA	320	240	0.077	492.4/457.2/262.7		
HQVGA	240	160	0.038	683.2/634.4/365.0		
QQVGA	160	120	0.019	849.9/789.2/454.6		
Max. × half	1296	516	0.669	246.2/227.8/131.6		246.2/218.4/131.6
Max. × min.	1296	8	0.01	2131.1/1894.1/1168.0		
Min. × max.	8	1032	0.008	132.5/123.0/70.4		
Min. × min.	8	8	64 P	2644.2/2455.3/1405.9		

¹ Mono8 at `SensorBitDepth` = 8-Bit⁽²⁾ / Mono10 at `SensorBitDepth` = 10-Bit / Mono12 or at `SensorBitDepth` = 12-Bit

² The `SensorBitDepth` value must be set separately from `PixelFormat`. See [Sensor ADC readout modes for maximum frame rates](#) on page 53 for details.

Table 19: Alvium G5-130m SWIR ROI frame rates

Alvium G5-203m/c

Feature	Specification	
	G5-203m	G5-203c
Sensor model	IMX422	
Resolution	1632 (H) × 1248 (V); 2.03 MP	
Sensor type	CMOS	
Shutter type	Global shutter (GS)	
Sensor size	Type 1/1.7; 7.3 mm × 5.6 mm; 9.2 mm diagonal	
Pixel size	4.5 μm × 4.5 μm	
CRA	0° deg	
Sensor bit depth (ADC)	8-bit, 10-bit, 12-bit; Adaptive (10-bit, 12-bit)	
Monochrome pixel formats	Mono8 (default), Mono10, Mono10p, Mono12, Mono12p, Mono12Packed	Mono8, Mono10, Mono10p, Mono12, Mono12p, Mono12Packed
YUV color pixel formats	Not applicable	YCbCr411_8_CbYYCrYY, YCbCr422_8_CbYCrY, YCbCr8_CbYCr
RGB color pixel formats	Not applicable	BGR8, RGB8 (default)
Raw color pixel formats	Not applicable	BayerRG8, BayerRG10, BayerRG10p, BayerRG12, BayerRG12p, BayerRG12Packed
Maximum frame rate	225 fps (at 525MByte/s)	
Exposure time	18 μs to 10 s (525 MByte/s)	
Exposure modes	Timed, TriggerControlled, TriggerWidth	
Gain	0 dB to 48 dB; 0.1 dB increments	
Digital binning	Horizontal: 1 to 8 columns; Vertical: 1 to 8 rows	
Sensor binning (H × V)	2 × 2 (<i>Sum, Average</i>)	Not applicable
Multiple ROI (H × V)	<i>Free Tile Horizontal</i> : 1 × 1 to 1 × 4 <i>Vertical</i> : 1 × 1 to 4 × 1	
Image buffer (RAM)	512 MByte	
Non-volatile memory (Flash)	1024 KByte	
Inputs and outputs	1 opto-isolated input, 1 opto-isolated output, 2 non-isolated GPIOs	
Power requirements	12 to 24 VDC	
Power requirements (PoE)	IEEE 802.3af	
Power consumption (typical)	External power: 6.3 W at 12 VDC Power over Ethernet: 6.9 W	
Storage temperature	-20 °C to +85 °C ambient temperature	
Operating temperature	-20 °C to +60 °C (Housing), -20 °C to +85 °C (Mainboard ¹)	
Humidity	0% to 80% humidity (non-condensing)	
Digital interface	5GBASE-T, 2.5GBASE-T, 1000BASE-T	
Camera controls	GenICam (GenICam Access)	

¹ Output by DeviceTemperature

Table 20: Alvium G5-203m/c specifications

Absolute QE, spectral response

We intend to add diagrams in a future version of this document.

ROI frame rates

Values are based on the conditions defined in [Specified values](#) on page 52. To reach the maximum frame rate available for typical operation, the bandwidth for image traffic is 525 MByte/s.

Image format	Width [pixels]	Height [pixels]	ROI area [MP]	Frame rate [fps] ¹		
				525 MByte/s	400 MByte/s	300MByte/s
Full resolution	1632	1248	2.037	225.5/117.9/118.5	191.3/95.7/95.7	143.6/71.8/71.8
WXGA+	1440	900	1.296	302.4/179.3/179.8	300.6/150.4/150.4	225.5/112.8/112.8
SXGA	1280	1024	1.311	271.6/180.0/179.4	271.6/148.7/148.7	223.0/111.5/111.5
HD 720	1280	720	0.922	370.9/246.3/245.3	370.9/211.5/211.3	317.0/158.6/158.6
XGA	1024	768	0.786	353.2/287.6/245.0	353.2/247.7/245.0	353.2/185.9/185.9
SVGA	800	600	0.48	440.7/358.5/306.1		440.7/304.3/304.4
VGA	640	480	0.307	535.2/435.4/372.4		535.2/435.5/372.4
HVGA	480	320	0.154	747.3/609.4/521.7		
QVGA	320	240	0.077	937.5/765.0/658.5		
HQVGA	240	160	0.038	1247.5/1019.0/881.6		
QQVGA	160	120	0.019	1501.8/1227.8/1066.8		
Max. × half	1632	624	1.018	413.6/218.7/219.6	382.4/191.2/191.3	287.0/143.5/143.5
Max. × min.	1632	8	0.013	2343.7/1400.7/1385.4		
Min. × max.	8	1248	0.01	232.6/189.4/161.1		
Min. × min.	8	8	64 P	3437.4/2828.0/2540.0		

¹ Mono8 or Bayer...8⁽²⁾ at **SensorBitDepth** = 8-Bit⁽³⁾ /
 Mono10 or Bayer...10 at **SensorBitDepth** = 10-Bit /
 Mono12 or Bayer...12 at **SensorBitDepth** = 12-Bit

² The three dots... represent the colors of a Bayer pixel format, such as in Bayer**RG8**.

³ The **SensorBitDepth** value must be set separately from **PixelFormat**.
 See [Sensor ADC readout modes for maximum frame rates](#) on page 53 for details.

Table 21: Alvium G5-203m/c ROI frame rates

Alvium G5-240m/c

Feature	Specification	
	G5-240m	G5-240c
Sensor model	Sony IMX392	
Resolution	1936 (H) × 1216 (V); 2.4 MP	
Sensor type	CMOS	
Shutter type	Global shutter (GS)	
Sensor size	Type 1/2.3; 6.7 mm × 4.2 mm; 7.9 mm diagonal	
Pixel size	3.45 μm × 3.45 μm	
CRA	0 deg	
Sensor bit depth (ADC)	8-bit, 10-bit, 12-bit; Adaptive (10-bit, 12-bit)	
Monochrome pixel formats	Mono8 (default), Mono10, Mono10p, Mono12, Mono12p, Mono12Packed	Mono8, Mono10, Mono10p, Mono12, Mono12p, Mono12Packed
YUV color pixel formats	Not applicable	YCbCr411_8_CbYYCrYY, YCbCr422_8_CbYCrY, YCbCr8_CbYCr
RGB color pixel formats	Not applicable	BGR8, RGB8 (default)
Raw color pixel formats	Not applicable	BayerRG8, BayerRG10, BayerRG10p, BayerRG12, BayerRG12p, BayerRG12Packed
Maximum frame rate	191 fps (at 525 MByte/s)	
Exposure time	26 μs to 10 s (525 MByte/s)	
Exposure modes	Timed, TriggerControlled, TriggerWidth	
Gain	0 dB to 48 dB; 0.1 dB increments	
Digital binning	Horizontal: 1 to 8 columns; Vertical: 1 to 8 rows	
Sensor binning (H × V)	2 × 2 (<i>Sum</i>)	Not applicable
Multiple ROI (H × V)	<i>Free</i> <i>Tile</i>	
Image buffer (RAM)	512 MByte	
Non-volatile memory (Flash)	1024 KByte	
Inputs and outputs	1 opto-isolated input, 1 opto-isolated output, 2 non-isolated GPIOs	
Power requirements	12 to 24 VDC	
Power requirements (PoE)	IEEE 802.3af	
Power consumption (typical)	External power: 6.0 W at 12 VDC Power over Ethernet: 6.5 W	
Storage temperature	-20 °C to +85 °C ambient temperature	
Operating temperature	-20 °C to +60 °C (Housing), -20 °C to +85 °C (Mainboard ¹)	
Humidity	0% to 80% humidity (non-condensing)	
Digital interface	5GBASE-T, 2.5GBASE-T, 1000BASE-T	
Camera controls	GenICam (GenICam Access)	

¹ Output by DeviceTemperature

Table 22: Alvium G5-240m/c specifications

Absolute QE

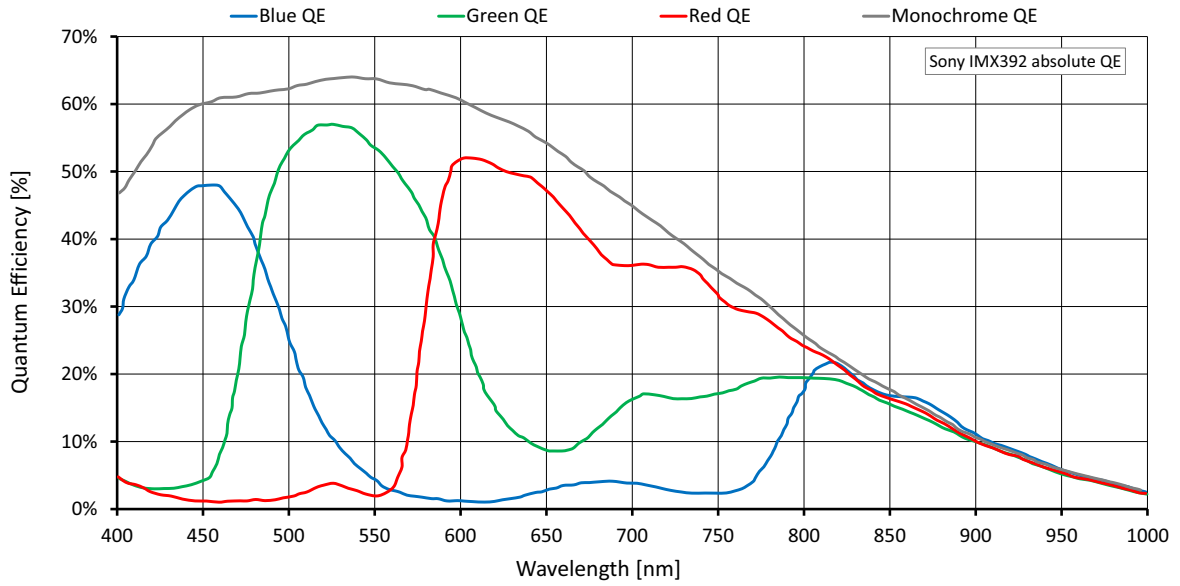

Figure 5: Alvium G5-240m/c (Sony IMX392) absolute QE

Spectral response

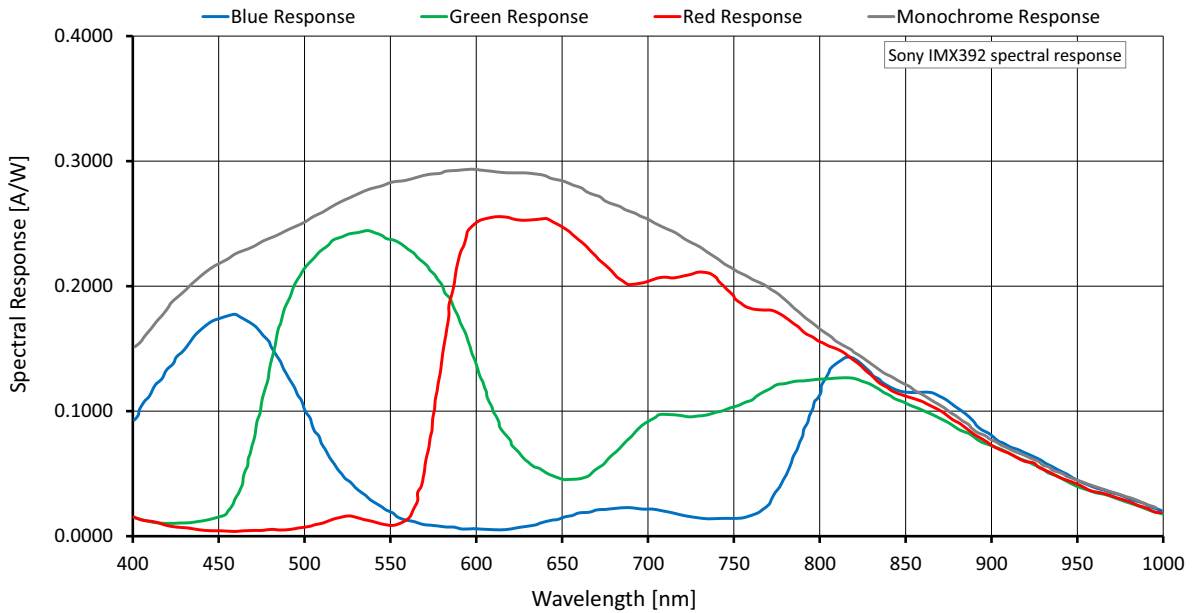

Figure 6: Alvium G5-240m/c (Sony IMX392) spectral response

ROI frame rates

Values are based on the conditions defined in [Specified values](#) on page 52. To reach the maximum frame rate available for typical operation, the bandwidth for image traffic is 525 MByte/s.

Image format	Width [pixels]	Height [pixels]	ROI area [MP]	Frame rate [fps] ¹		
				525 MByte/s	400 MByte/s	300MByte/s
Full resolution	1936	1216	2.354	191.9/104.7/104.0	165.6/82.8/82.8	124.2/62.1/62.1
Full HD	1920	1080	2.074	214.2/118.1/117.5	187.9/94.0/94.0	141.0/70.5/70.5
UXGA	1600	1200	1.92	195.4/128.1/127.5	195.4/101.5/101.5	152.3/76.1/76.1
WXGA+	1440	900	1.296	255.7/185.9/171.5	255.7/150.4/150.4	225.6/112.8/112.8
SXGA	1280	1024	1.311	227.8/185.3/152.7	227.8/148.7/148.6	223.0/111.5/111.5
HD 720	1280	720	0.922	314.7/256.2/211.4	314.7/211.5/211.4	314.7/158.6/158.5
XGA	1024	768	0.786	298.6/246.4/200.5		298.6/185.8/185.8
SVGA	800	600	0.48	376.1/310.1/253.0		376.1/304.2/253.0
VGA	640	480	0.307	461.1/381.2/310.8		
HVGA	480	320	0.154	658.4/545.6/447.1		
QVGA	320	240	0.077	833.4/701.5/574.7		
HQVGA	240	160	0.038	1135.0/968.3/796.3		
QQVGA	160	120	0.019	1385.9/1192.2/983.7		
Max. × half	1936	608	1.177	359.4/197.9/196.4	330.9/165.4/165.4	248.4/124.2/124.2
Max. × min.	1936	8	0.015	2533.8/1666.7/1601.3		
Min. × max.	8	1216	0.01	196.4/162.5/132.1		
Min. × min.	8	8	64 P	3635.4/3381.1/2883.3		

¹ Mono8 or Bayer...8⁽²⁾ at **SensorBitDepth** = 8-Bit⁽³⁾ /
 Mono10 or Bayer...10 at **SensorBitDepth** = 10-Bit /
 Mono12 or Bayer...12 at **SensorBitDepth** = 12-Bit

² The three dots... represent the colors of a Bayer pixel format, such as in Bayer**RG8**.

³ The **SensorBitDepth** value must be set separately from **PixelFormat**.
 See [Sensor ADC readout modes for maximum frame rates](#) on page 53 for details.

Table 23: Alvium G5-240m/c ROI frame rates

Alvium G5-291m/c

Feature	Specification	
	G5-291m	G5-291c
Sensor model	Sony IMX421	
Resolution	1944 (H) x 1472 (V); 2.9 MP	
Sensor type	CMOS	
Shutter type	Global shutter (GS)	
Sensor size	Type 2/3; 8.8 mm x 6.6 mm; 10.8 mm diagonal	
Pixel size	4.5 μm x 4.5 μm	
CRA	0 deg	
Sensor bit depth (ADC)	8-bit, 10-bit, 12-bit; Adaptive (10-bit, 12-bit)	
Monochrome pixel formats	Mono8 (default), Mono10, Mono10p, Mono12, Mono12p, Mono12Packed	Mono8, Mono10, Mono10p, Mono12, Mono12p, Mono12Packed
YUV color pixel formats	Not applicable	YCbCr411_8_CbYYCrYY, YCbCr422_8_CbYCrY, YCbCr8_CbYCr
RGB color pixel formats	Not applicable	BGR8, RGB8 (default)
Raw color pixel formats	Not applicable	BayerRG8, BayerRG10, BayerRG10p, BayerRG12, BayerRG12p, BayerRG12Packed
Maximum frame rate	166 fps (at 525 MByte/s)	
Exposure time	17 μs to 10 s (525 MByte/s)	
Exposure modes	Timed, TriggerControlled, TriggerWidth	
Gain	0 dB to 48 dB; 0.1 dB increments	
Digital binning	Horizontal: 1 to 8 columns; Vertical: 1 to 8 rows	
Sensor binning (H x V)	2 x 2 (<i>Sum, Average</i>)	Not applicable
Multiple ROI (H x V)	<i>Free Tile Horizontal</i> : 1 x 1 to 1 x 4 <i>Vertical</i> : 1 x 1 to 4 x 1	
Image buffer (RAM)	512 MByte	
Non-volatile memory (Flash)	1024 KByte	
Inputs and outputs	1 opto-isolated input, 1 opto-isolated output, 2 non-isolated GPIOs	
Power requirements	12 to 24 VDC	
Power requirements (PoE)	IEEE 802.3af	
Power consumption (typical)	External power: 6.6 W at 12 VDC Power over Ethernet: 7.2 W	
Storage temperature	-20 °C to +85 °C ambient temperature	
Operating temperature	-20 °C to +60 °C (Housing), -20 °C to +85 °C (Mainboard ¹)	
Humidity	0% to 80% humidity (non-condensing)	
Digital interface	5GBASE-T, 2.5GBASE-T, 1000BASE-T	
Camera controls	GenICam (GenICam Access)	

¹ Output by DeviceTemperature

Table 24: Alvium G5-291m/c specifications

Absolute QE, spectral response

We intend to add diagrams in a future version of this document.

ROI frame rates

Values are based on the conditions defined in [Specified values](#) on page 52. To reach the maximum frame rate available for typical operation, the bandwidth for image traffic is 525 MByte/s.

Image format	Width [pixels]	Height [pixels]	ROI area [MP]	Frame rate [fps] ¹		
				525 MByte/s	400 MByte/s	300MByte/s
Full resolution	1944	1472	2.862	166.3/85.8/85.4	136.2/68.1/68.1	102.2/51.1/51.1
Full HD	1920	1080	2.074	220.4/115.3/115.0	187.9/94.0/94.0	141.0/70.5/70.5
UXGA	1600	1200	1.92	201.5/125.3/125.0	201.5/101.5/101.5	152.2/76.1/76.1
WXGA+	1440	900	1.296	260.7/180.0/180.5	260.7/150.4/150.4	225.5/112.8/112.8
SXGA	1280	1024	1.311	234.0/180.7/164.3	234.0/148.7/148.7	223.0/111.5/111.5
HD 720	1280	720	0.922	319.9/247.5/225.2	319.9/211.5/211.3	317.2/158.6/158.5
XGA	1024	768	0.786	304.4/251.9/214.3	304.4/247.6/214.3	304.4/185.9/185.8
SVGA	800	600	0.48	379.9/314.7/268.1		379.9/304.1/268.1
VGA	640	480	0.307	461.2/383.1/326.9		
HVGA	480	320	0.154	645.2/536.6/459.5		
QVGA	320	240	0.077	808.5/676.1/580.8		
HQVGA	240	160	0.038	1077.9/906.1/782.6		
QQVGA	160	120	0.019	1299.9/1097.4/952.1		
Max. × half	1944	736	1.431	308.7/161.1/160.3	272.3/136.2/136.1	204.3/102.1/102.1
Max. × min.	1944	8	0.016	2024.2/1238.5/1211.8		
Min. × max.	8	1472	0.012	170.8/141.1/119.7		
Min. × min.	8	8	64 P	2979.5/2599.8/2338.0		

¹ Mono8 or Bayer...8⁽²⁾ at **SensorBitDepth** = 8-Bit⁽³⁾ /
 Mono10 or Bayer...10 at **SensorBitDepth** = 10-Bit /
 Mono12 or Bayer...12 at **SensorBitDepth** = 12-Bit

² The three dots... represent the colors of a Bayer pixel format, such as in Bayer**RG8**.

³ The **SensorBitDepth** value must be set separately from **PixelFormat**.
 See [Sensor ADC readout modes for maximum frame rates](#) on page 53 for details.

Table 25: Alvium G5-291m/c ROI frame rates

Alvium G5-320 VSWIR (coming soon)

Feature	Specification
	G5-320 VSWIR (monochrome)
Sensor model	Sony IMX993
Resolution	2080(H) × 1544 (V); 3.2 MP
Sensor type	InGaAs
Shutter type	Global shutter (GS)
Sensor size	Type 1/1.8; 7.2 mm × 5.3 mm; 8.9 mm diagonal
Pixel size	3.45 μm × 3.45 μm
CRA	Tbd
Sensor bit depth (ADC)	8-bit, 10-bit, 12-bit; Adaptive (10-bit, 12-bit)
Monochrome pixel formats	Mono8 (default), Mono10, Mono10p, Mono12, Mono12p, Mono12Packed
Maximum frame rate	131 fps (at 525 MByte/s)
Exposure time	24 μs to 10 s (525 MByte/s)
Exposure modes	Timed, TriggerControlled, TriggerWidth
Gain	0 dB to 48 dB; 0.1 dB increments
Digital binning	Horizontal: 1 to 8 columns; Vertical: 1 to 8 rows
Multiple ROI (H × V)	Free Tile Horizontal: 1 × 1 to 1 × 4 Vertical: 1 × 1 to 4 × 1
Image buffer (RAM)	512 MByte
Non-volatile memory (Flash)	1024 KByte
Inputs and outputs	1 opto-isolated input, 1 opto-isolated output, 2 non-isolated GPIOs
Power requirements	12 to 24 VDC
Power requirements (PoE)	IEEE 802.3af
Power consumption (typical)	Tbd
Storage temperature	-20 °C to +85 °C ambient temperature
Operating temperature	-20 °C to +60 °C (Housing), -20 °C to +85 °C (Mainboard ¹)
Humidity	0% to 80% humidity (non-condensing)
Digital interface	5GBASE-T, 2.5GBASE-T, 1000BASE-T
Camera controls	GenICam (GenICam Access)

¹ Output by DeviceTemperature

Table 26: Alvium G5-320 VSWIR specifications

Absolute QE, spectral response

We intend to add diagrams in a future version of this document.

ROI frame rates

Values are based on the conditions defined in [Specified values](#) on page 52. To reach the maximum frame rate available for typical operation, the bandwidth for image traffic is 525 MByte/s.

Image format	Width [pixels]	Height [pixels]	ROI area [MP]	Frame rate [fps] ¹		
				525 MByte/s	400 MByte/s	300MByte/s
Full resolution	2080	1544	3.212	131.3 / 73.5 / 72.8	111.5 / 56.2 / 56.1	84.2 / 42.4 / 42.3
QXGA	2048	1536	3.146	132.0 / 75.2 / 74.7	113.1 / 57.2 / 57.3	85.9 / 43.3 / 43.2
Full HD	1920	1080	2.074	180.1 / 109.2 / 108.6	164.5 / 83.8 / 83.5	125.3 / 63.0 / 62.9
UXGA	1600	1200	1.920	165.1 / 119.4 / 110.2	165.1 / 91.8 / 91.6	137.4 / 68.9 / 69.0
WXGA+	1440	900	1.296	211.2 / 169.1 / 140.9	211.2 / 130.4 / 128.8	192.9 / 98.1 / 97.9
SXGA	1280	1024	1.311	190.4 / 156.1 / 127.0	190.4 / 130.7 / 127.0	190.4 / 99.2 / 98.8
HD 720	1280	720	0.922	255.8 / 209.8 / 170.7	255.8 / 175.8 / 170.7	255.8 / 133.6 / 133.0
XGA	1024	768	0.786	243.9 / 200.0 / 162.8		243.9 / 157.7 / 157.2
SVGA	800	600	0.480	299.4 / 245.9 / 199.9		
VGA	640	480	0.307	357.6 / 293.7 / 238.8		
HVGA	480	320	0.154	481.6 / 395.8 / 321.8		
QVGA	320	240	0.077	584.9 / 480.9 / 391.0		
HQVGA	240	160	0.038	739.8 / 608.6 / 496.4		
QQVGA	160	120	0.019	857.5 / 705.8 / 573.8		
Max. × half	2080	772	1.606	236.8 / 133.4 / 131.9	201.7 / 102.4 / 101.9	152.9 / 77.4 / 77.0
Max. × min.	2080	8	0.017	1204.1 / 719.1 / 694.4	1057.3 / 570.3 / 554.5	831.8 / 442.2 / 433.4
Min. × max.	8	1544	0.012	134.3 / 110.2 / 89.6		
Min. × min.	8	8	64 P	1519.3 / 1254.2 / 1019.7		

¹ Mono8 or Bayer...8⁽²⁾ at **SensorBitDepth** = 8-Bit⁽³⁾ /
 Mono10 or Bayer...10 at **SensorBitDepth** = 10-Bit /
 Mono12 or Bayer...12 at **SensorBitDepth** = 12-Bit

² The three dots... represent the colors of a Bayer pixel format, such as in Bayer**RG8**.

³ The **SensorBitDepth** value must be set separately from **PixelFormat**.

See [Sensor ADC readout modes for maximum frame rates](#) on page 53 for details.

Table 27: Alvium G5-320 VSWIR ROI frame rates (calculated values)

Alvium G5-500m/c

Feature	Specification	
	G5-500m	G5-500c
Sensor model	ON Semiconductor AR0521SR	
Resolution	2592 (H) × 1944 (V); 5.0 MP	
Sensor type	CMOS	
Shutter type	Rolling shutter (RS)	
Sensor size	Type 1/2.5; 5.7 mm × 4.3 mm; 7.1 mm diagonal	
Pixel size	2.2 μm × 2.2 μm	
CRA	9 deg	
Sensor bit depth (ADC)	10-bit	
Monochrome pixel formats	Mono8 (default), Mono10, Mono10p, Mono12, Mono12p, Mono12Packed	Mono8, Mono10, Mono10p, Mono12, Mono12p, Mono12Packed
YUV color pixel formats	Not applicable	YCbCr411_8_CbYYCrYY, YCbCr422_8_CbYCrY, YCbCr8_CbYCr
RGB color pixel formats	Not applicable	BGR8, RGB8 (default)
Raw color pixel formats	Not applicable	BayerGR8, BayerGR10, BayerGR10p, BayerGR12, BayerGR12p, BayerGR12Packed
Maximum frame rate	68 fps ¹ (at ≥400MByte/s)	
Exposure time	8 μs to 10 s (400 MByte/s)	
Exposure modes	Timed	
Gain	0 dB to 24.1 dB; 0.1 dB increments	
Digital binning	Horizontal: 1 to 8 columns; Vertical: 1 to 8 rows	
Sensor binning (H × V)	2 × 1, 4 × 1 (<i>Sum</i>)	
Image buffer (RAM)	512 MByte	
Non-volatile memory (Flash)	1024 KByte	
Inputs and outputs	1 opto-isolated input, 1 opto-isolated output, 2 non-isolated GPIOs	
Power requirements	12 to 24 VDC	
Power requirements (PoE)	IEEE 802.3af	
Power consumption (typical)	External power: 5.5 W at 12 VDC Power over Ethernet: 6.3 W	
Storage temperature	-20 °C to +85 °C ambient temperature	
Operating temperature	-20 °C to +60 °C (Housing), -20 °C to +85 °C (Mainboard ²)	
Humidity	0% to 80% humidity (non-condensing)	
Digital interface	5GBASE-T, 2.5GBASE-T, 1000BASE-T	
Camera controls	GenICam (GenICam Access)	
¹ In triggered mode: ~34 fps		
² Output by DeviceTemperature		

Table 28: Alvium G5-500m/c specifications

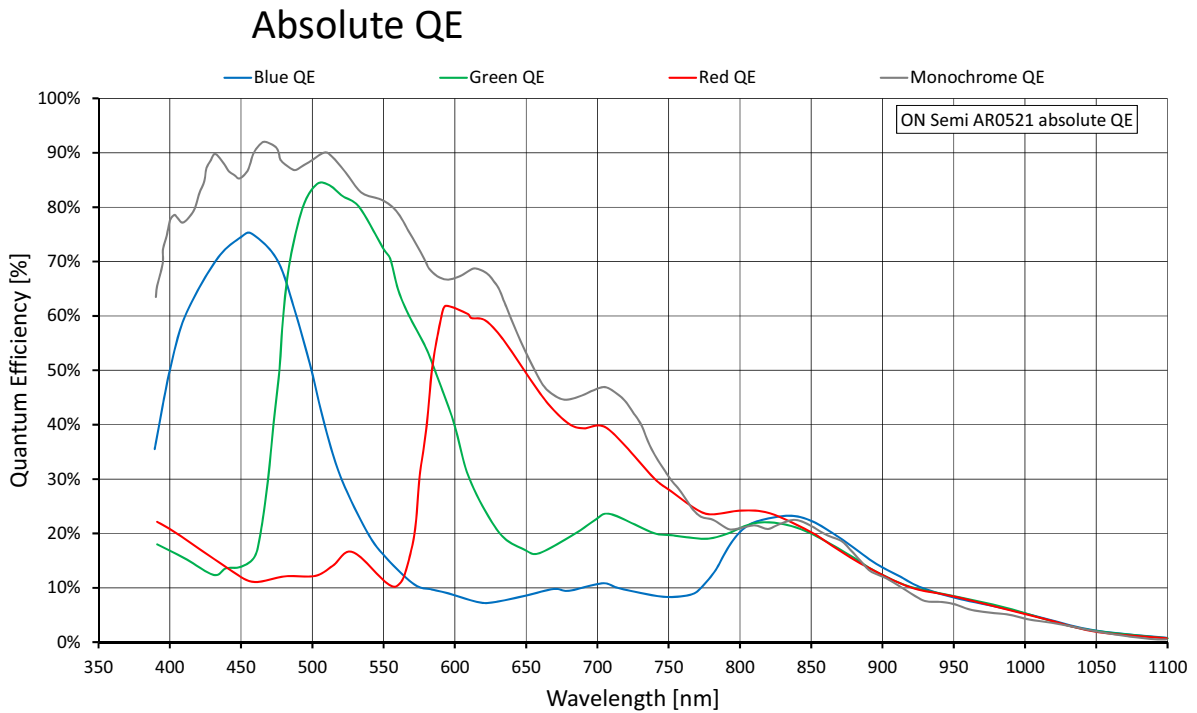

Figure 7: Alvim G5-500m/c (ON Semi AR0521) absolute QE

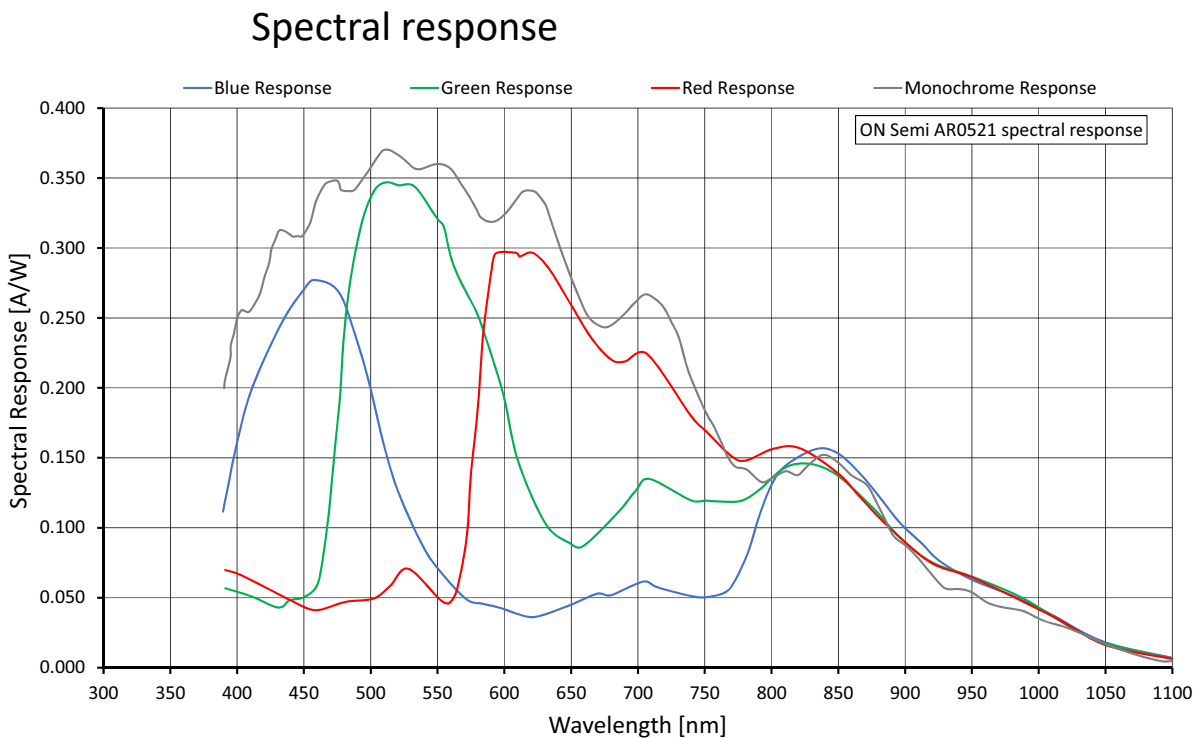

Figure 8: Alvim G5-500m/c (ON Semi AR0521) spectral response

ROI frame rates

Values are based on the conditions defined in [Specified values](#) on page 52. To reach the maximum frame rate available for typical operation, the bandwidth for image traffic is 400 MByte/s. Increasing the `DeviceLinkThroughputLimit` value does not increase frame rates.

Shutter mode	User mode	Available frame rates
Rolling shutter (RS)	Freerun	Values in Table 30 below are reached.
Rolling shutter (RS)	Triggered	>50% of the values for in Table 30 below are reached.

Table 29: Frame rate behavior for different configurations

Image format	Width [pixels]	Height [pixels]	ROI area [MP]	Frame rate [fps] ¹		
				525 MByte/s	400 MByte/s	300MByte/s
Full resolution	2592	1944	5.039	68.1/50.8	68.1/38.7	58.0/29.0
WQHD	2560	1440	3.686	91.1/68.9	91.1/52.9	79.3/39.7
QXGA	2048	1536	3.146	85.9/81.0	85.9/62.0	85.9/46.5
Full HD	1920	1080	2.074	120.5/120.5	120.5/94.0	120.5/70.5
UXGA	1600	1200	1.92	109.2/109.2	109.2/101.5	109.2/76.1
WXGA+	1440	900	1.296	143.9/143.8		143.9/112.7
SXGA	1280	1024	1.311	127.4/127.4		127.4/111.5
HD 720	1280	720	0.922	178.0/178.0		178.0/158.5
XGA	1024	768	0.786	167.9/167.9		
SVGA	800	600	0.48	212.1/212.1		
VGA	640	480	0.307	261.4/261.4		
HVGA	480	320	0.154	379.3/378.2		
QVGA	320	240	0.077	489.7/489.7		
HQVGA	240	160	0.038	687.5/687.5		
QQVGA	160	120	0.019	861.5/861.5		
Max. × half	2592	972	2.519	132.6/99.3	132.6/77.3	116.0/58.0
Max. × min.	2592	8	0.021	2159.2/1747.9		
Min. × max.	8	1944	0.016	68.7/68.7		
Min. × min.	8	8	64 P	2956.0/2956.0		

¹ Mono8 or Bayer...8⁽²⁾ at `SensorBitDepth` = 10-Bit /
Mono10 or Bayer...10 at `SensorBitDepth` = 10-Bit

² The three dots... represent the colors of a Bayer pixel format, such as in BayerRG8.

Table 30: Alvim G5-500m/c ROI frame rates

Alvium G5-507m/c Pol (coming soon)



Please observe

For first series models, pixel processing has not been adjusted to enable the complete functionality available with non-polarizer models:

- Only raw pixel formats are supported, but no formats for polarizer sensors.
- Features based on pixel processing are available but cannot be used to generate a proper output. For example, color processing, binning, convolution filter, DPC, or FPNC are not supported.

Feature	Specification	
	G5-507m Pol (monochrome)	G5-507c Pol (color)
Sensor model	Sony IMX264MZR	Sony IMX264MYR
Resolution	2464 (H) × 2056 (V); 5.1 MP	
Sensor type	CMOS	
Shutter type	Global shutter (GS)	
Sensor size	Type 2/3; 8.5 mm × 7.1 mm; 11.1 mm diagonal	
Pixel size	3.45 μm × 3.45 μm	
CRA	0 deg	
Sensor bit depth (ADC)	12-bit	
Monochrome pixel formats	Mono8 (default), Mono10, Mono10p, Mono12, Mono12p, Mono12Packed	Not applicable
Raw color pixel formats	Not applicable	BayerRG8, BayerRG10, BayerRG10p, BayerRG12, BayerRG12p, BayerRG12Packed
Maximum frame rate	34 fps (at ≥300 MByte/s)	
Exposure time	28 μs to 10 s (at 300 MByte/s)	
Exposure modes	Timed, TriggerControlled, TriggerWidth	
Gain	0 dB to 48 dB; 0.1 dB increments	
Multiple ROI (H × V)	<i>Free</i>	
Image buffer (RAM)	512 MByte	
Non-volatile memory (Flash)	1024 KByte	
Inputs and outputs	1 opto-isolated input, 1 opto-isolated output, 2 non-isolated GPIOs	
Power requirements	12 to 24 VDC	
Power requirements (PoE)	IEEE 802.3af	
Power consumption (typical)	Tbd	

Table 31: Alvium G5-507m/c Pol specifications (sheet 1 of 2)

Feature	Specification
Storage temperature	-20 °C to +85 °C ambient temperature
Operating temperature	-20 °C to +60 °C (Housing), -20 °C to +85 °C (Mainboard ¹)
Humidity	0% to 80% humidity (non-condensing)
Digital interface	5GBASE-T, 2.5GBASE-T, 1000BASE-T
Camera controls	GenICam (GenICam Access)
¹ Output by DeviceTemperature	

Table 31: Alvium G5-507m/c Pol specifications (sheet 2 of 2)

Absolute QE, spectral response

We intend to add diagrams in a future version of this document.

ROI frame rates

Values are based on the conditions defined in [Specified values](#) on page 52. To reach the maximum frame rate available for typical operation, the bandwidth for image traffic is 300 MByte/s. Increasing the `DeviceLinkThroughputLimit` value does not increase frame rates.

Image format	Width [pixels]	Height [pixels]	ROI area [MP]	Frame rate [fps] ¹		
				525 MByte/s	400 MByte/s	300MByte/s
Full resolution	2464	2056	5.066	34.9 / 34.9		34.9 / 28.6
QXGA	2048	1536	3.146	46.4 / 46.4		46.4 / 45.8
Full HD	1920	1080	2.074	64.9 / 64.9		
UXGA	1600	1200	1.920	58.9 / 58.9		
WXGA+	1440	900	1.296	77.4 / 77.4		
SXGA	1280	1024	1.311	68.6 / 68.6		
HD 720	1280	720	0.922	95.5 / 95.5		
XGA	1024	768	0.786	90.2 / 90.2		
SVGA	800	600	0.480	113.7 / 113.7		
VGA	640	480	0.307	139.6 / 139.6		
HVGA	480	320	0.154	200.3 / 200.3		
QVGA	320	240	0.077	257.3 / 257.3		
HQVGA	240	160	0.038	356.3 / 356.3		
QQVGA	160	120	0.019	441.1 / 441.1		
Max. × half	2464	1028	2.533	67.8 / 67.8		67.8 / 55.6
Max. × min.	2464	8	0.020	1015.1 / 1015.1		1015.1 / 866.6
Min. × max.	8	2056	0.016	35.2 / 35.2		
Min. × min.	8	8	64 P	1323.2 / 1323.2		

¹ Mono8 or Bayer...8⁽²⁾ at `SensorBitDepth` = 8-Bit⁽³⁾ /
 Mono10 or Bayer...10 at `SensorBitDepth` = 10-Bit /
 Mono12 or Bayer...12 at `SensorBitDepth` = 12-Bit

² The three dots... represent the colors of a Bayer pixel format, such as in BayerRG8.

³ The `SensorBitDepth` value must be set separately from `PixelFormat`.
 See [Sensor ADC readout modes for maximum frame rates](#) on page 53 for details.

Table 32: Alvium G5-507m/c Pol ROI frame rates

Alvium G5-508m/c

Feature	Specification	
	G5-508m (monochrome)	G5-508c (color)
Sensor model	Sony IMX250-LLR	Sony IMX250-LQR
Resolution	2464 (H) x 2056 (V); 5.1 MP	
Sensor type	CMOS	
Shutter type	Global shutter (GS)	
Sensor size	Type 2/3; 8.5 mm x 7.1 mm; 11.1 mm diagonal	
Pixel size	3.45 μm x 3.45 μm	
CRA	0 deg	
Sensor bit depth (ADC)	8-bit, 10-bit, 12-bit; Adaptive (10-bit, 12-bit)	
Monochrome pixel formats	Mono8 (default), Mono10, Mono10p, Mono12, Mono12p, Mono12Packed	Mono8, Mono10, Mono10p, Mono12, Mono12p, Mono12Packed
YUV color pixel formats	Not applicable	YCbCr411_8_CbYYCrYY, YCbCr422_8_CbYCrY, YCbCr8_CbYCr
RGB color pixel formats	Not applicable	BGR8, RGB8 (default)
Raw color pixel formats	Not applicable	BayerRG8, BayerRG10, BayerRG10p, BayerRG12, BayerRG12p, BayerRG12Packed
Maximum frame rate	95 fps (at 525 MByte/s)	
Exposure time	19 μs to 10 s (525 MByte/s)	
Exposure modes	Timed, TriggerControlled, TriggerWidth	
Gain	0 dB to 48 dB; 0.1 dB increments	
Digital binning	Horizontal: 1 to 8 columns; Vertical: 1 to 8 rows	
Sensor binning (H x V)	1 x 2 (<i>Sum</i>)	Not applicable
Multiple ROI (H x V)	<i>Free Tile Horizontal: 1 x 1 to 1 x 4 Vertical: 1 x 1 to 4 x 1</i>	
Image buffer (RAM)	512 MByte	
Non-volatile memory (Flash)	1024 KByte	
Inputs and outputs	1 opto-isolated input, 1 opto-isolated output, 2 non-isolated GPIOs	
Power requirements	12 to 24 VDC	
Power requirements (PoE)	IEEE 802.3af	
Power consumption (typical)	External power: 6.1 W at 12 VDC Power over Ethernet: 7.0 W	
Storage temperature	-20 °C to +85 °C ambient temperature	
Operating temperature	-20 °C to +60 °C (Housing), -20 °C to +85 °C (Mainboard ¹)	
Humidity	0% to 80% humidity (non-condensing)	
Digital interface	5GBASE-T, 2.5GBASE-T, 1000BASE-T	
Camera controls	GenICam (GenICam Access)	

¹ Output by DeviceTemperature

Table 33: Alvium G5-508m/c specifications

Absolute QE

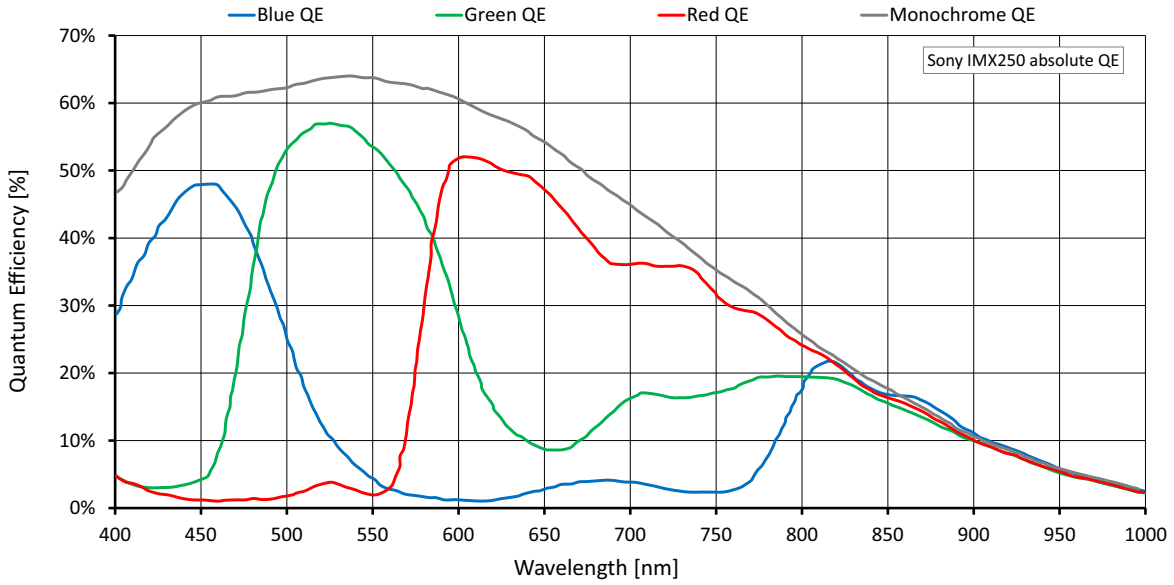

Figure 9: Alvium G5-508m/c (Sony IMX250) absolute QE

Spectral response

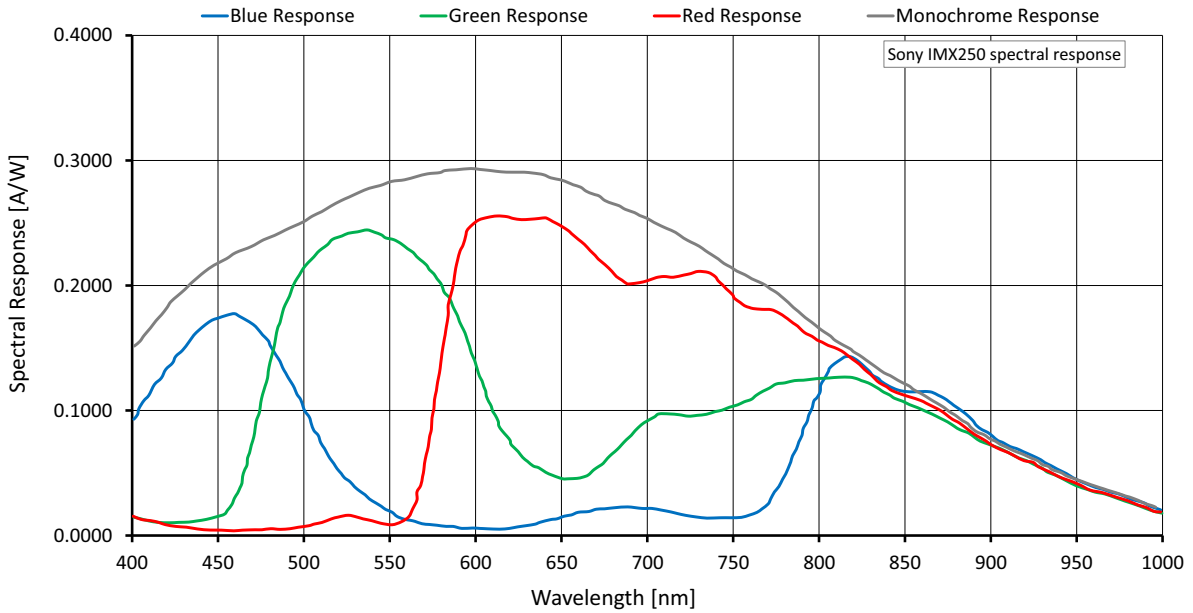

Figure 10: Alvium G5-508m/c (Sony IMX250) spectral response

ROI frame rates

Values are based on the conditions defined in [Specified values](#) on page 52. To reach the maximum frame rate available for typical operation, the bandwidth for image traffic is 525 MByte/s.

Image format	Width [pixels]	Height [pixels]	ROI area [MP]	Frame rate [fps] ¹		
				525 MByte/s	400 MByte/s	300MByte/s
Full resolution	2464	2056	5.066	95.1/49.8/49.9	76.9/38.5/38.5	57.7/28.9/28.9
QXGA	2048	1536	3.146	126.0/79.4/78.9	123.9/62.0/62.0	92.9/46.5/46.5
Full HD	1920	1080	2.074	175.7/117.9/117.1	175.7/94.0/94.0	141.0/70.5/70.5
UXGA	1600	1200	1.92	160.0/127.9/111.4	160.0/101.5/101.5	152.2/76.1/76.1
WXGA+	1440	900	1.296	209.6/171.3/146.0	209.6/150.3/146.0	209.6/112.7/112.8
SXGA	1280	1024	1.311	186.5/152.4/129.9	186.5/148.7/129.9	186.5/111.5/111.5
HD 720	1280	720	0.922	258.2/210.9/179.8		258.2/158.6/158.6
XGA	1024	768	0.786	244.9/200.1/170.6		244.9/185.8/170.6
SVGA	800	600	0.48	308.1/252.0/214.5		
VGA	640	480	0.307	378.4/309.6/263.4		
HVGA	480	320	0.154	541.1/442.6/377.3		
QVGA	320	240	0.077	686.8/567.5/483.8		
HQVGA	240	160	0.038	940.0/783.3/667.8		
QQVGA	160	120	0.019	1152.4/964.5/822.2		
Max. × half	2464	1028	2.533	182.5/96.2/96.2	153.8/76.9/76.9	115.4/57.7/57.7
Max. × min.	2464	8	0.02	2081.4/1278.0/1198.6		
Min. × max.	8	2056	0.016	96.5/79.1/67.4		
Min. × min.	8	8	64 P	3138.2/2735.3/2331.8		

¹ Mono8 or Bayer...8⁽²⁾ at **SensorBitDepth** = 8-Bit⁽³⁾ /
 Mono10 or Bayer...10 at **SensorBitDepth** = 10-Bit /
 Mono12 or Bayer...12 at **SensorBitDepth** = 12-Bit

² The three dots... represent the colors of a Bayer pixel format, such as in Bayer**RG8**.

³ The **SensorBitDepth** value must be set separately from **PixelFormat**.
 See [Sensor ADC readout modes for maximum frame rates](#) on page 53 for details.

Table 34: Alvium G5-508m/c ROI frame rates

Alvium G5-508m/c Pol

(Alvium G5-508c Pol is coming soon.)



Please observe

For first series models, pixel processing has not been adjusted to enable the complete functionality available with non-polarizer models:

- Only raw pixel formats are supported, but no formats for polarizer sensors.
- Features based on pixel processing are available but cannot be used to generate a proper output. For example, color processing, binning, convolution filter, DPC, or FPNC are not supported.

Feature	Specification	
	G5-508m Pol (monochrome)	G5-508c Pol (color)
Sensor model	Sony IMX250MZR	Sony IMX250MYR
Resolution	2464 (H) x 2056 (V); 5.1 MP	
Sensor type	CMOS	
Shutter type	Global shutter (GS)	
Sensor size	Type 2/3; 8.5 mm x 7.1 mm; 11.1 mm diagonal	
Pixel size	3.45 μm x 3.45 μm	
CRA	0 deg	
Sensor bit depth (ADC)	8-bit, 10-bit, 12-bit; Adaptive (10-bit, 12-bit)	
Monochrome pixel formats	Mono8 (default), Mono10, Mono10p, Mono12, Mono12p, Mono12Packed	Not applicable
Raw color pixel formats	Not applicable	BayerRG8, BayerRG10, BayerRG10p, BayerRG12, BayerRG12p, BayerRG12Packed
Maximum frame rate	95 fps (at 525 MByte/s)	
Exposure time	19 μs to 10 s (525 MByte/s)	
Exposure modes	Timed, TriggerControlled, TriggerWidth	
Gain	0 dB to 48 dB; 0.1 dB increments	
Multiple ROI (H x V)	<i>Free Tile Horizontal</i> : 1 x 1 to 1 x 4 <i>Vertical</i> : 1 x 1 to 4 x 1	
Image buffer (RAM)	512 MByte	
Non-volatile memory (Flash)	1024 KByte	
Inputs and outputs	1 opto-isolated input, 1 opto-isolated output, 2 non-isolated GPIOs	
Power requirements	12 to 24 VDC	
Power requirements (PoE)	IEEE 802.3af	

Table 35: Alvium G5-508m/c Pol specifications (sheet 1 of 2)

Feature	Specification
Power consumption (typical)	External power: 6.1 W at 12 VDC Power over Ethernet: 7.0 W
Storage temperature	-20 °C to +85 °C ambient temperature
Operating temperature	-20 °C to +60 °C (Housing), -20 °C to +85 °C (Mainboard ¹)
Humidity	0% to 80% humidity (non-condensing)
Digital interface	5GBASE-T, 2.5GBASE-T, 1000BASE-T
Camera controls	GenICam (GenICam Access)
¹ Output by DeviceTemperature	

Table 35: Alvium G5-508m/c Pol specifications (sheet 2 of 2)

Absolute QE, spectral response

We intend to add diagrams in a future version of this document.

ROI frame rates

Values are based on the conditions defined in [Specified values](#) on page 52. To reach the maximum frame rate available for typical operation, the bandwidth for image traffic is 525 MByte/s.

Image format	Width [pixels]	Height [pixels]	ROI area [MP]	Frame rate [fps] ¹		
				525 MByte/s	400 MByte/s	300MByte/s
Full resolution	2464	2056	5.066	95.1/49.8/49.9	76.9/38.5/38.5	57.7/28.9/28.9
QXGA	2048	1536	3.146	126.0/79.4/78.9	123.9/62.0/62.0	92.9/46.5/46.5
Full HD	1920	1080	2.074	175.7/117.9/117.1	175.7/94.0/94.0	141.0/70.5/70.5
UXGA	1600	1200	1.92	160.0/127.9/111.4	160.0/101.5/101.5	152.2/76.1/76.1
WXGA+	1440	900	1.296	209.6/171.3/146.0	209.6/150.3/146.0	209.6/112.7/112.8
SXGA	1280	1024	1.311	186.5/152.4/129.9	186.5/148.7/129.9	186.5/111.5/111.5
HD 720	1280	720	0.922	258.2/210.9/179.8		258.2/158.6/158.6
XGA	1024	768	0.786	244.9/200.1/170.6		244.9/185.8/170.6
SVGA	800	600	0.48	308.1/252.0/214.5		
VGA	640	480	0.307	378.4/309.6/263.4		
HVGA	480	320	0.154	541.1/442.6/377.3		
QVGA	320	240	0.077	686.8/567.5/483.8		
HQVGA	240	160	0.038	940.0/783.3/667.8		
QQVGA	160	120	0.019	1152.4/964.5/822.2		
Max. × half	2464	1028	2.533	182.5/96.2/96.2	153.8/76.9/76.9	115.4/57.7/57.7
Max. × min.	2464	8	0.02	2081.4/1278.0/1198.6		
Min. × max.	8	2056	0.016	96.5/79.1/67.4		
Min. × min.	8	8	64 P	3138.2/2735.3/2331.8		

¹ Mono8 or Bayer...8⁽²⁾ at **SensorBitDepth** = 8-Bit⁽³⁾ /
 Mono10 or Bayer...10 at **SensorBitDepth** = 10-Bit /
 Mono12 or Bayer...12 at **SensorBitDepth** = 12-Bit

² The three dots... represent the colors of a Bayer pixel format, such as in Bayer**RG8**.

³ The **SensorBitDepth** value must be set separately from **PixelFormat**.
 See [Sensor ADC readout modes for maximum frame rates](#) on page 53 for details.

Table 36: Alvium G5-508m/c Pol ROI frame rates

Alvium G5-510m/c

Feature	Specification	
	G5-510m (monochrome)	G5-510c (color)
Sensor model	Sony IMX548	
Resolution	2464 (H) × 2064 (V); 5.1 MP	
Sensor type	CMOS	
Shutter type	Global shutter (GS)	
Sensor size	Type 1/1.8; 6.8 mm × 5.7 mm; 8.8 mm diagonal	
Pixel size	2.74 μm × 2.74 μm	
CRA	0 deg	
Sensor bit depth (ADC)	12-bit	
Monochrome pixel formats	Mono8 (default), Mono10, Mono10p, Mono12, Mono12p, Mono12Packed	Mono8, Mono10, Mono10p, Mono12, Mono12p, Mono12Packed
YUV color pixel formats	Not applicable	YCbCr411_8_CbYYCrYY, YCbCr422_8_CbYCrY, YCbCr8_CbYCr
RGB color pixel formats	Not applicable	BGR8, RGB8 (default)
Raw color pixel formats	Not applicable	BayerRG8, BayerRG10, BayerRG10p, BayerRG12, BayerRG12p, BayerRG12Packed
Maximum frame rate	81 fps (at 525 MByte/s)	
Exposure time	8 μs to 10 s (525 MByte/s)	
Exposure modes	Timed	
Gain	0 dB to 48 dB; 0.1 dB increments	
Digital binning	Horizontal: 1 to 8 columns; Vertical: 1 to 8 rows	
Sensor binning (H × V)	2 × 2 (<i>Sum</i>)	Not applicable
Multiple ROI (H × V)	<i>Free Tile Horizontal</i> : 1 × 1 to 1 × 4 <i>Vertical</i> : 1 × 1 to 4 × 1	
Image buffer (RAM)	512 MByte	
Non-volatile memory (Flash)	1024 KByte	
GPIOs	4 programmable GPIOs	
	As direct inputs (push-pull): 0 to 5.5 VDC	
	As direct outputs (push-pull): 0 to 3.3 VDC at 12 mA	
Power requirements	12 to 24 VDC	
Power requirements (PoE)	IEEE 802.3af	
Power consumption (typical)	External power: 6.2 W at 12 VDC Power over Ethernet: 6.9 W	
Storage temperature	-20 °C to +85 °C ambient temperature	
Operating temperature	-20 °C to +60 °C (Housing), -20 °C to +85 °C (Mainboard ¹)	
Humidity	0% to 80% humidity (non-condensing)	
Digital interface	5GBASE-T, 2.5GBASE-T, 1000BASE-T	
Camera controls	GenICam (GenICam Access)	

¹ Output by DeviceTemperature

Table 37: Alvium G5-510m/c specifications

Absolute QE

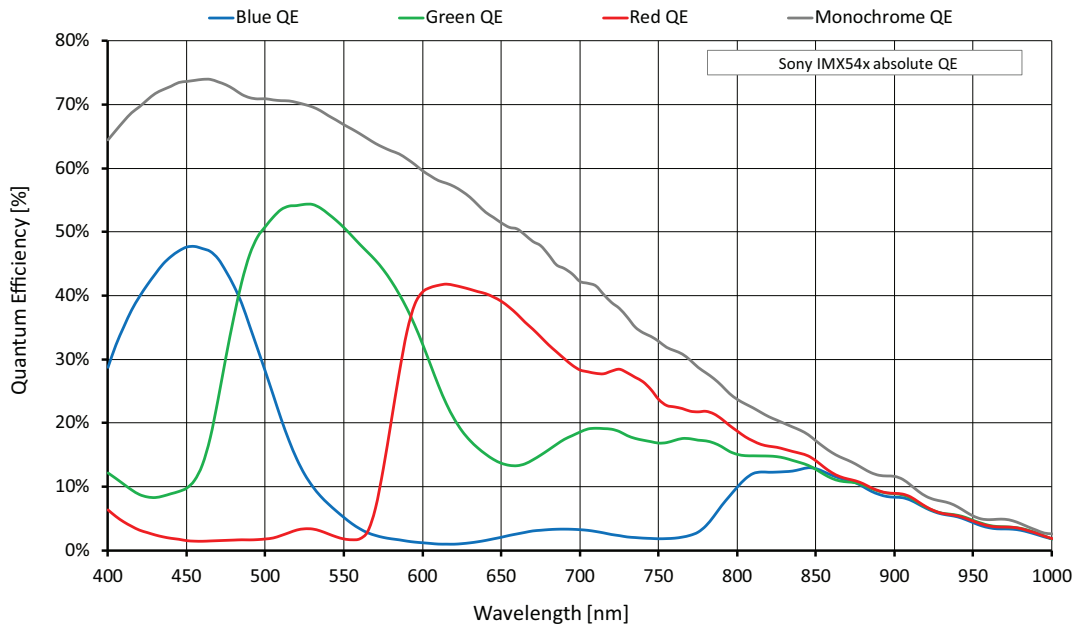

Figure 11: Alvium G5-510m/c (Sony IMX548) absolute QE

Spectral response

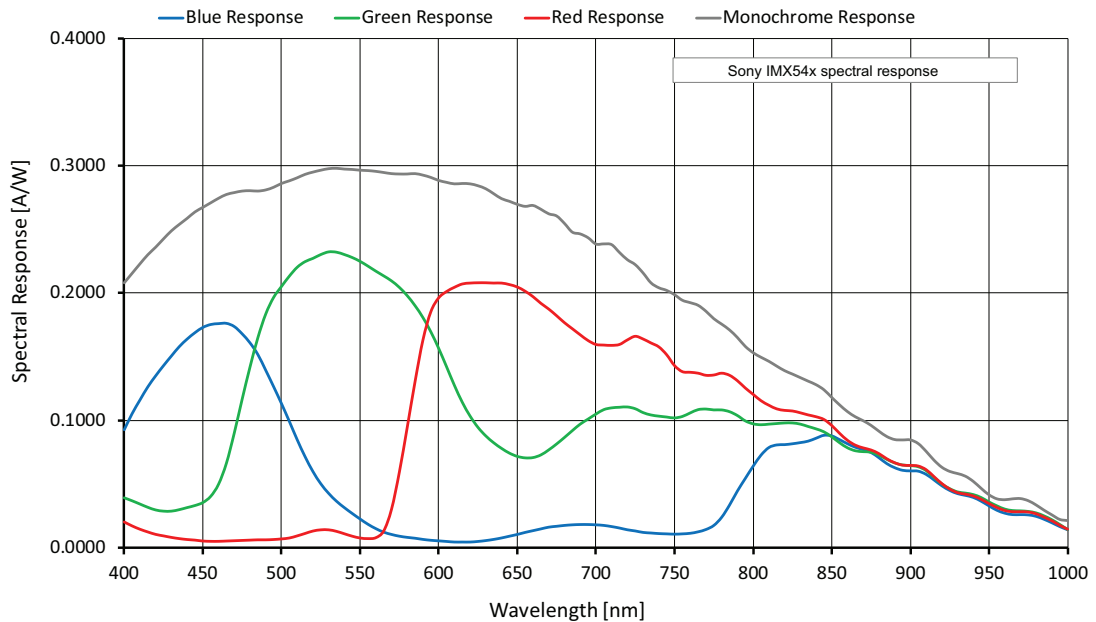

Figure 12: Alvium G5-510m/c (Sony IMX548) spectral response

ROI frame rates

Values are based on the conditions defined in [Specified values](#) on page 52. To reach the maximum frame rate available for typical operation, the bandwidth for image traffic is 525 MByte/s.

Image format	Width [pixels]	Height [pixels]	ROI area [MP]	Frame rate [fps] ¹		
				525 MByte/s	400 MByte/s	300MByte/s
Full resolution	2464	2064	5.086	81.5/47.4	76.4/38.2	57.3/28.7
QXGA	2048	1536	3.146	106.7/74.8	106.7/62.0	92.9/46.5
Full HD	1920	1080	2.074	145.4/108.6	145.4/94.0	140.9/70.5
UXGA	1600	1200	1.92	133.3/119.4	133.3/101.5	133.3/76.2
WXGA+	1440	900	1.296	170.2/168.3	170.2/150.4	170.2/112.8
SXGA	1280	1024	1.311	153.4/153.4	153.4/148.7	153.4/111.5
HD 720	1280	720	0.922	205.6/205.6		205.6/158.6
XGA	1024	768	0.786	195.9/195.9		195.9/185.8
SVGA	800	600	0.48	239.9/239.6		
VGA	640	480	0.307	285.4/285.4		
HVGA	480	320	0.154	380.5/379.7		
QVGA	320	240	0.077	456.0/456.0		
HQVGA	240	160	0.038	569.0/569.0		
QQVGA	160	120	0.019	649.4/649.4		
Max. × half	2472	1032	2.551	150.2/87.8	150.2/76.4	114.6/57.3
Max. × min.	2472	8	0.02	918.9/576.5		
Min. × max.	8	2064	0.017	82.5/82.5		
Min. × min.	8	8	64 P	1074.8/1074.8		

¹ Mono8 or Bayer...8⁽²⁾ at **SensorBitDepth** =12-Bit / Mono12 or Bayer...12 at **SensorBitDepth** = 12-Bit

² The three dots... represent the colors of a Bayer pixel format, such as in Bayer**RG8**.

Table 38: Alvium G5-510m/c ROI frame rates

Alvium G5-511m/c

Feature	Specification	
	G5-511m (monochrome)	G5-511c (color)
Sensor model	Sony IMX547	
Resolution	2464 (H) × 2064 (V); 5.1 MP	
Sensor type	CMOS	
Shutter type	Global shutter (GS)	
Sensor size	Type 1/1.8; 6.8 mm × 5.7 mm; 8.8 mm diagonal	
Pixel size	2.74 μm × 2.74 μm	
CRA	0 deg	
Sensor bit depth (ADC)	12-bit	
Monochrome pixel formats	Mono8 (default), Mono10, Mono10p, Mono12, Mono12p, Mono12Packed	Mono8, Mono10, Mono10p, Mono12, Mono12p, Mono12Packed
YUV color pixel formats	Not applicable	YCbCr411_8_CbYYCrYY, YCbCr422_8_CbYCrY, YCbCr8_CbYCr
RGB color pixel formats	Not applicable	BGR8, RGB8 (default)
Raw color pixel formats	Not applicable	BayerRG8, BayerRG10, BayerRG10p, BayerRG12, BayerRG12p, BayerRG12Packed
Maximum frame rate	79 fps (at 525 MByte/s)	
Exposure time	8 μs to 10 s (525 MByte/s)	
Exposure modes	Timed, TriggerControlled, TriggerWidth	
Gain	0 dB to 48 dB; 0.1 dB increments	
Digital binning	Horizontal: 1 to 8 columns; Vertical: 1 to 8 rows	
Sensor binning (H × V)	2 × 2 (<i>Sum</i>)	Not applicable
Multiple ROI (H × V)	<i>Free</i> <i>Tile</i> <i>Horizontal</i> : 1 × 1 to 1 × 4 <i>Vertical</i> : 1 × 1 to 4 × 1	
Image buffer (RAM)	512 MByte	
Non-volatile memory (Flash)	1024 KByte	
GPIOs	4 programmable GPIOs As direct inputs (push-pull): 0 to 5.5 VDC As direct outputs (push-pull): 0 to 3.3 VDC at 12 mA	
Power requirements	12 to 24 VDC	
Power requirements (PoE)	IEEE 802.3af	
Power consumption (typical)	External power: 6.5 W at 12 VDC Power over Ethernet: 7.1 W	
Storage temperature	-20 °C to +85 °C ambient temperature	
Operating temperature	-20 °C to +60 °C (Housing), -20 °C to +85 °C (Mainboard ¹)	
Humidity	0% to 80% humidity (non-condensing)	
Digital interface	5GBASE-T, 2.5GBASE-T, 1000BASE-T	
Camera controls	GenICam (GenICam Access)	

¹ Output by DeviceTemperature

Table 39: Alvium G5-511m/c specifications

Absolute QE

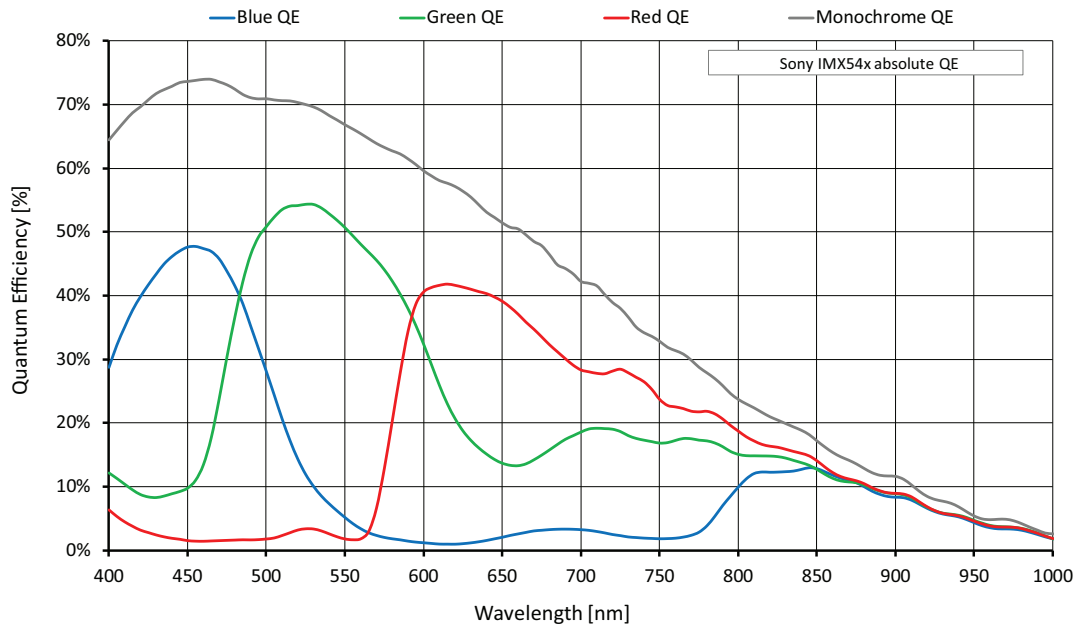

Figure 13: Alvium G5-511m/c (Sony IMX547) absolute QE

Spectral response

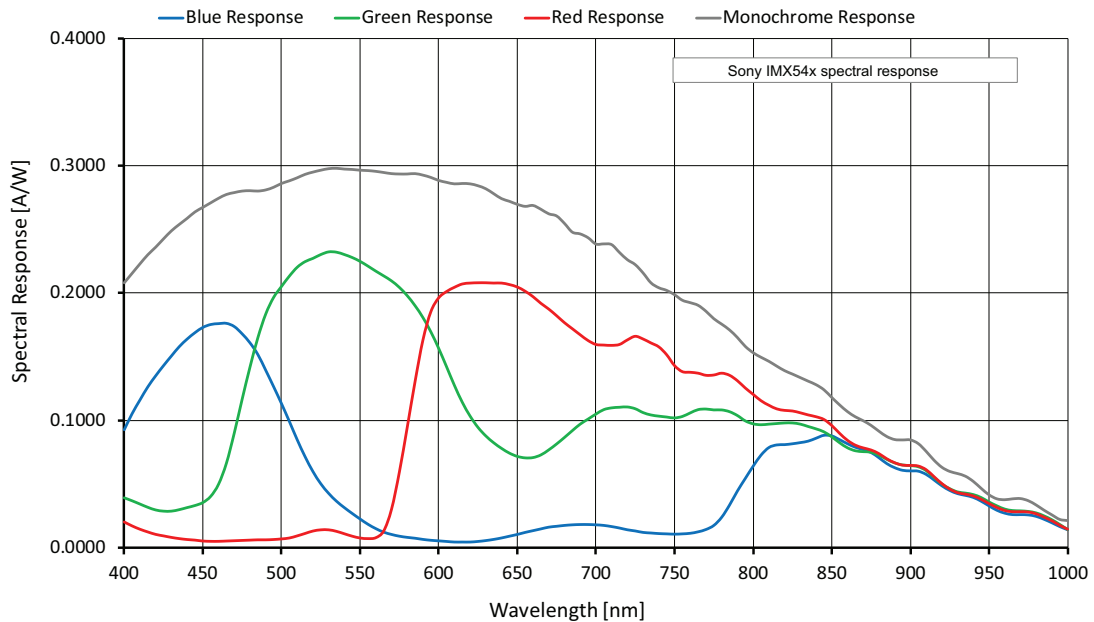

Figure 14: Alvium G5-511m/c (Sony IMX547) spectral response

ROI frame rates

Values are based on the conditions defined in [Specified values](#) on page 52. To reach the maximum frame rate available for typical operation, the bandwidth for image traffic is 525 MByte/s.

Image format	Width [pixels]	Height [pixels]	ROI area [MP]	Frame rate [fps] ¹		
				525 MByte/s	400 MByte/s	300MByte/s
Full resolution	2464	2064	5.086	79.9/47.6	76.7/38.3	57.5/28.7
QXGA	2048	1536	3.146	104.7/74.8	104.7/62.0	92.9/46.5
Full HD	1920	1080	2.074	142.7/108.6	142.7/94.0	141.0/70.5
UXGA	1600	1200	1.92	130.8/119.4	130.8/101.5	130.8/76.2
WXGA+	1440	900	1.296	166.9/166.9	166.9/150.3	166.9/112.8
SXGA	1280	1024	1.311	150.6/150.4	150.6/148.7	150.6/111.5
HD 720	1280	720	0.922	201.8/201.6		201.8/158.5
XGA	1024	768	0.786	192.3/192.3		192.3/185.8
SVGA	800	600	0.48	235.3/235.3		
VGA	640	480	0.307	279.8/279.8		
HVGA	480	320	0.154	373.1/373.1		
QVGA	320	240	0.077	447.2/447.2		
HQVGA	240	160	0.038	557.9/557.9		
QQVGA	160	120	0.019	636.8/636.8		
Max. × half	2472	1032	2.551	147.4/88.3	147.4/76.6	114.9/57.5
Max. × min.	2472	8	0.02	905.6/579.8	905.6/579.8	905.6/579.8
Min. × max.	8	2064	0.017	80.9/80.9		
Min. × min.	8	8	64 P	1053.9/1053.9		

¹ Mono8 or Bayer...8⁽²⁾ at **SensorBitDepth** =12-Bit / Mono12 or Bayer...12 at **SensorBitDepth** = 12-Bit

² The three dots... represent the colors of a Bayer pixel format, such as in Bayer**RG8**.

Table 40: Alvium G5-511m/c ROI frame rates

Alvium G5-530 VSWIR (coming soon)

Feature	Specification
	G5-530 VSWIR (monochrome)
Sensor model	Sony IMX992
Resolution	2592(H) × 2056(V); 5.3 MP
Sensor type	InGaAs
Shutter type	Global shutter (GS)
Sensor size	Type 1/1.4; 8.9 mm × 7.1 mm; 11.4 mm diagonal
Pixel size	3.45 μm × 3.45 μm
CRA	Tbd
Sensor bit depth (ADC)	8-bit, 10-bit, 12-bit; Adaptive (10-bit, 12-bit)
Monochrome pixel formats	Mono8 (default), Mono10, Mono10p, Mono12, Mono12p, Mono12Packed
Maximum frame rate	84 fps (at 525 MByte/s)
Exposure time	26 μs to 10 s (525 MByte/s)
Exposure modes	Timed, TriggerControlled, TriggerWidth
Gain	0 dB to 48 dB; 0.1 dB increments
Digital binning	Horizontal: 1 to 8 columns; Vertical: 1 to 8 rows
Multiple ROI (H × V)	Free Tile Horizontal: 1 × 1 to 1 × 4 Vertical: 1 × 1 to 4 × 1
Image buffer (RAM)	512 MByte
Non-volatile memory (Flash)	1024 KByte
Inputs and outputs	1 opto-isolated input, 1 opto-isolated output, 2 non-isolated GPIOs
Power requirements	12 to 24 VDC
Power requirements (PoE)	IEEE 802.3af
Power consumption (typical)	Tbd
Storage temperature	-20 °C to +85 °C ambient temperature
Operating temperature	-20 °C to +60 °C (Housing), -20 °C to +85 °C (Mainboard ¹)
Humidity	0% to 80% humidity (non-condensing)
Digital interface	5GBASE-T, 2.5GBASE-T, 1000BASE-T
Camera controls	GenICam (GenICam Access)

¹ Output by DeviceTemperature

Table 41: Alvium G5-530 VSWIR specifications

Absolute QE, spectral response

We intend to add diagrams in a future version of this document.

ROI frame rates

Values are based on the conditions defined in [Specified values](#) on page 52. To reach the maximum frame rate available for typical operation, the bandwidth for image traffic is 525 MByte/s.

Image format	Width [pixels]	Height [pixels]	ROI area [MP]	Frame rate [fps] ¹		
				525 MByte/s	400 MByte/s	300MByte/s
Full resolution	2592	2056	5.329	84.7 / 45.4 / 45.2	68.8 / 34.7 / 34.6	51.9 / 26.1 / 26.1
QXGA	2560	2048	5.243	85.0 / 46.2 / 46.1	70.2 / 35.2 / 35.2	52.8 / 26.5 / 26.5
WQHD	2560	1440	3.686	116.9 / 63.7 / 63.4	96.7 / 48.6 / 48.5	72.8 / 36.6 / 36.5
QXGA	2048	1536	3.146	110.9 / 75.2 / 74.7	110.9 / 57.2 / 57.3	85.9 / 43.3 / 43.2
Full HD	1920	1080	2.074	151.5 / 109.2 / 105.2	151.5 / 83.8 / 83.5	125.3 / 63.0 / 62.9
UXGA	1600	1200	1.920	138.8 / 113.3 / 96.4	138.8 / 91.8 / 91.6	137.4 / 68.9 / 69.0
WXGA+	1440	900	1.296	177.7 / 145.0 / 123.4	177.7 / 130.4 / 123.4	177.7 / 98.1 / 97.9
SXGA	1280	1024	1.311	160.0 / 130.7 / 111.1		160.0 / 99.2 / 98.8
HD 720	1280	720	0.922	215.2 / 175.8 / 149.4		215.2 / 133.6 / 133.0
XGA	1024	768	0.786	205.0 / 167.4 / 142.3		205.0 / 157.7 / 142.3
SVGA	800	600	0.480	251.9 / 205.4 / 174.8		
VGA	640	480	0.307	300.7 / 245.5 / 209.0		
HVGA	480	320	0.154	405.6 / 330.5 / 281.3		
QVGA	320	240	0.077	492.0 / 401.8 / 341.9		
HQVGA	240	160	0.038	623.1 / 508.8 / 433.1		
QQVGA	160	120	0.019	723.0 / 590.4 / 500.6		
Max. × half	2592	1028	2.665	156.3 / 84.2 / 83.6	127.3 / 64.5 / 64.3	96.4 / 48.7 / 48.6
Max. × min.	2592	8	0.021	1007.5 / 577.3 / 558.9	847.6 / 458.0 / 446.9	670.3 / 354.5 / 348.4
Min. × max.	8	2056	0.016	86.2 / 70.4 / 60.0		
Min. × min.	8	8	64 P	1279.8 / 1045.2 / 889.5		

¹ Mono8 or Bayer...8⁽²⁾ at **SensorBitDepth** = 8-Bit⁽³⁾ /
 Mono10 or Bayer...10 at **SensorBitDepth** = 10-Bit /
 Mono12 or Bayer...12 at **SensorBitDepth** = 12-Bit

² The three dots... represent the colors of a Bayer pixel format, such as in Bayer**RG8**.

³ The **SensorBitDepth** value must be set separately from **PixelFormat**.

See [Sensor ADC readout modes for maximum frame rates](#) on page 53 for details.

Table 42: Alvim G5-530 VSWIR ROI frame rates (calculated values)

Alvium G5-811m/c

Feature	Specification	
	G5-811m	G5-811c
Sensor model	Sony IMX546	
Resolution	2848 (H) × 2848 (V); 8.1 MP	
Sensor type	CMOS	
Shutter type	Global shutter (GS)	
Sensor size	Type 2/3; 7.8 mm × 7.8 mm; 11.0 mm diagonal	
Pixel size	2.74 μm × 2.74 μm	
CRA	0 deg	
Sensor bit depth (ADC)	12-bit	
Monochrome pixel formats	Mono8 (default), Mono10, Mono10p, Mono12, Mono12p, Mono12Packed	Mono8, Mono10, Mono10p, Mono12, Mono12p, Mono12Packed
YUV color pixel formats	Not applicable	YCbCr411_8_CbYYCrYY, YCbCr422_8_CbYCrY, YCbCr8_CbYCr
RGB color pixel formats	Not applicable	BGR8, RGB8 (default)
Raw color pixel formats	Not applicable	BayerRG8, BayerRG10, BayerRG10p, BayerRG12, BayerRG12p, BayerRG12Packed
Maximum frame rate	59 fps (at 525 MByte/s)	
Exposure time	8 μs to 10 s (525 MByte/s)	
Exposure modes	Timed, TriggerControlled, TriggerWidth	
Gain	0 dB to 48 dB; 0.1 dB increments	
Digital binning	Horizontal: 1 to 8 columns; Vertical: 1 to 8 rows	
Sensor binning (H × V)	2 × 2 (<i>Sum</i>)	Not applicable
Multiple ROI (H × V)	<i>Free Tile Horizontal</i> : 1 × 1 to 1 × 4 <i>Vertical</i> : 1 × 1 to 4 × 1	
Image buffer (RAM)	512 MByte	
Non-volatile memory (Flash)	1024 KByte	
Inputs and outputs	1 opto-isolated input, 1 opto-isolated output, 2 non-isolated GPIOs	
Power requirements	12 to 24 VDC	
Power requirements (PoE)	IEEE 802.3af	
Power consumption (typical)	External power: 6.5 W at 12 VDC Power over Ethernet: 7.1 W	
Storage temperature	-20 °C to +85 °C ambient temperature	
Operating temperature	-20 °C to +60 °C (Housing), -20 °C to +85 °C (Mainboard ¹)	
Humidity	0% to 80% humidity (non-condensing)	
Digital interface	5GBASE-T, 2.5GBASE-T, 1000BASE-T	
Camera controls	GenICam (GenICam Access)	

¹ Output by DeviceTemperature

Table 43: Alvium G5-811m/c specifications

Absolute QE

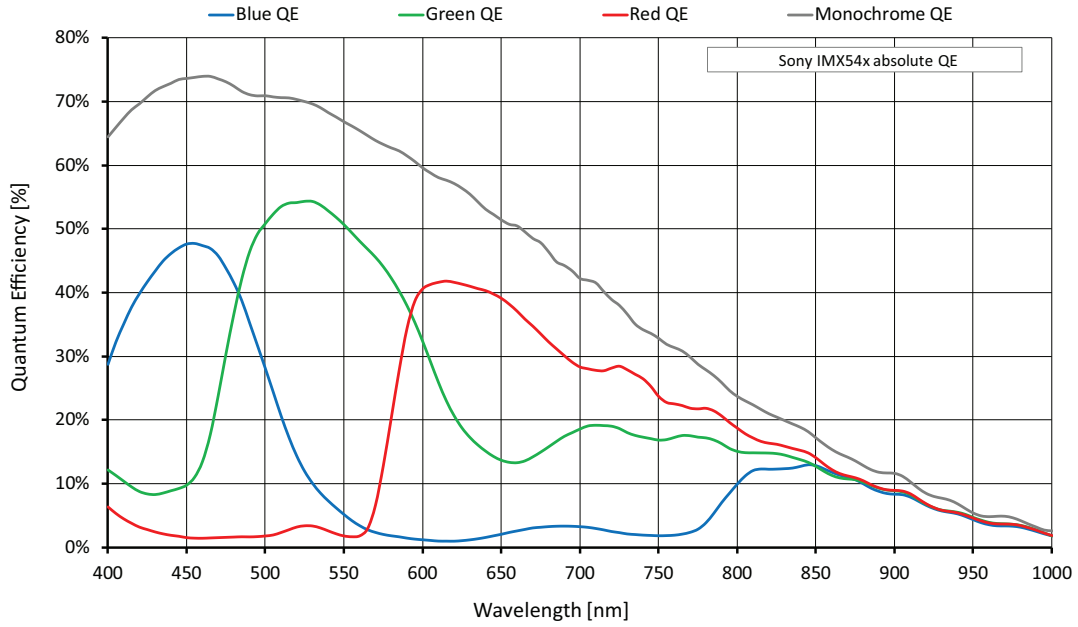

Figure 15: Alvium G5-811m/c (Sony IMX546) absolute QE

Spectral response

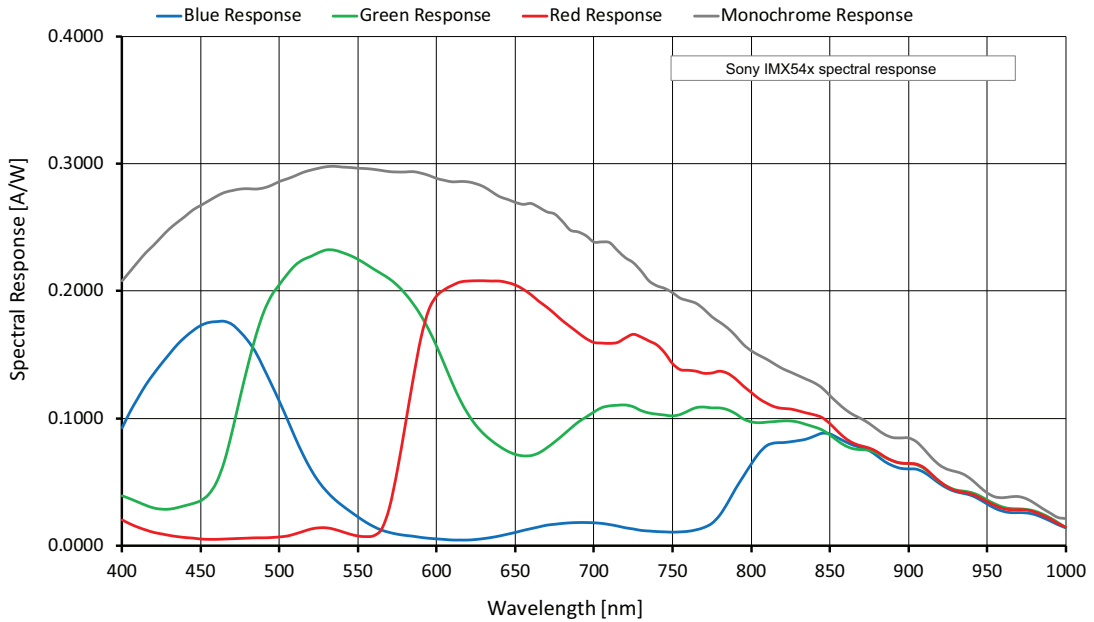

Figure 16: Alvium G5-811m/c (Sony IMX546) spectral response

ROI frame rates

Values are based on the conditions defined in [Specified values](#) on page 52. To reach the maximum frame rate available for typical operation, the bandwidth for image traffic is 525 MByte/s.

Image format	Width [pixels]	Height [pixels]	ROI area [MP]	Frame rate [fps] ¹		
				525 MByte/s	400 MByte/s	300MByte/s
Full resolution	2848	2848	8.111	59.2/30.4	48.1/24.0	36.1/18.0
QSXGA	2560	2048	5.243	80.5/46.1	74.3/37.2	55.8/27.9
WQHD	2560	1440	3.686	110.4/63.5	105.8/52.9	79.3/39.7
QXGA	2048	1536	3.146	104.7/74.8	104.7/62.0	92.9/46.5
Full HD	1920	1080	2.074	142.7/108.6	142.7/94.0	141.0/70.5
UXGA	1600	1200	1.92	130.8/119.4	130.8/101.5	130.8/76.2
WXGA+	1440	900	1.296	166.9/166.9	166.9/150.3	166.9/112.8
SXGA	1280	1024	1.311	150.6/150.4	150.6/148.7	150.6/111.5
HD 720	1280	720	0.922	201.8/201.6		201.8/158.5
XGA	1024	768	0.786	192.3/192.3		192.3/185.8
SVGA	800	600	0.48	235.3/235.3		
VGA	640	480	0.307	279.8/279.8		
HVGA	480	320	0.154	373.1/373.1		
QVGA	320	240	0.077	447.2/447.2		
HQVGA	240	160	0.038	557.9/557.9		
QQVGA	160	120	0.019	636.8/636.8		
Max. × half	2848	1424	4.056	111.2/57.4	96.1/48.1	72.1/36.1
Max. × min.	2848	8	0.023	883.4/502.1	883.4/502.1	883.4/502.1
Min. × max.	8	2848	0.023	59.9/59.9		
Min. × min.	8	8	64 P	1053.9/1053.9		

¹ Mono8 or Bayer...8⁽²⁾ at **SensorBitDepth** = 12-Bit / Mono12 or Bayer...12 at **SensorBitDepth** = 12-Bit

² The three dots... represent the colors of a Bayer pixel format, such as in Bayer**RG8**.

Table 44: Alvium G5-811m/c ROI frame rates

Alvium G5-812 UV



NOTICE

Sensor aging by UV radiation

The sensor in this camera model is dedicated for imaging in the UV spectrum. However, UV radiation causes aging, which is permanently increasing the dark current and decreasing the QE (quantum efficiency). To reduce sensor aging, we recommend you to:

- Minimize the intensity of UV radiation.
- Avoid wavelengths below 250 nm. For example, consider the use of bandpass filters to block shorter wavelengths.

Feature	Specification	
	G5-812 UV	
Sensor model	Sony IMX487	
Resolution	2848 (H) × 2848 (V); 8.1 MP	
Sensor type	CMOS	
Shutter type	Global shutter (GS)	
Sensor size	Type 2/3; 7.8 mm × 7.8 mm; 11.0 mm diagonal	
Pixel size	2.74 μm × 2.74 μm	
CRA	0 deg	
Sensor bit depth (ADC)	12-bit	
Monochrome pixel formats	Mono8 (default), Mono10, Mono10p, Mono12, Mono12p, Mono12Packed	
YUV color pixel formats	Not applicable	
RGB color pixel formats	Not applicable	
Maximum frame rate	58 fps (at 525 MByte/s)	
Exposure time	8 μs to 10 s (525 MByte/s)	
Exposure modes	Timed, TriggerControlled, TriggerWidth	
Gain	0 dB to 48 dB; 0.1 dB increments	
Digital binning	Horizontal: 1 to 8 columns; Vertical: 1 to 8 rows	
Sensor binning (H × V)	2 × 2 (<i>Sum</i>)	Not applicable
Multiple ROI (H × V)	<i>Free</i> <i>Tile</i> <i>Horizontal</i> : 1 × 1 to 1 × 4 <i>Vertical</i> : 1 × 1 to 4 × 1	
Image buffer (RAM)	512 MByte	
Non-volatile memory (Flash)	1024 KByte	
Inputs and outputs	1 opto-isolated input, 1 opto-isolated output, 2 non-isolated GPIOs	
Power requirements	12 to 24 VDC	
Power requirements (PoE)	IEEE 802.3af	
Power consumption (typical)	External power: 7.2 W at 12 VDC Power over Ethernet: 7.6 W	
Storage temperature	-20 °C to +85 °C ambient temperature	
Operating temperature	-20 °C to +60 °C (Housing), -20 °C to +85 °C (Mainboard ¹)	
Humidity	0% to 80% humidity (non-condensing)	
Digital interface	5GBASE-T, 2.5GBASE-T, 1000BASE-T	
Camera controls	GenICam (GenICam Access)	

¹ Output by DeviceTemperature

Table 45: Alvium G5-812 UV specifications

Absolute QE

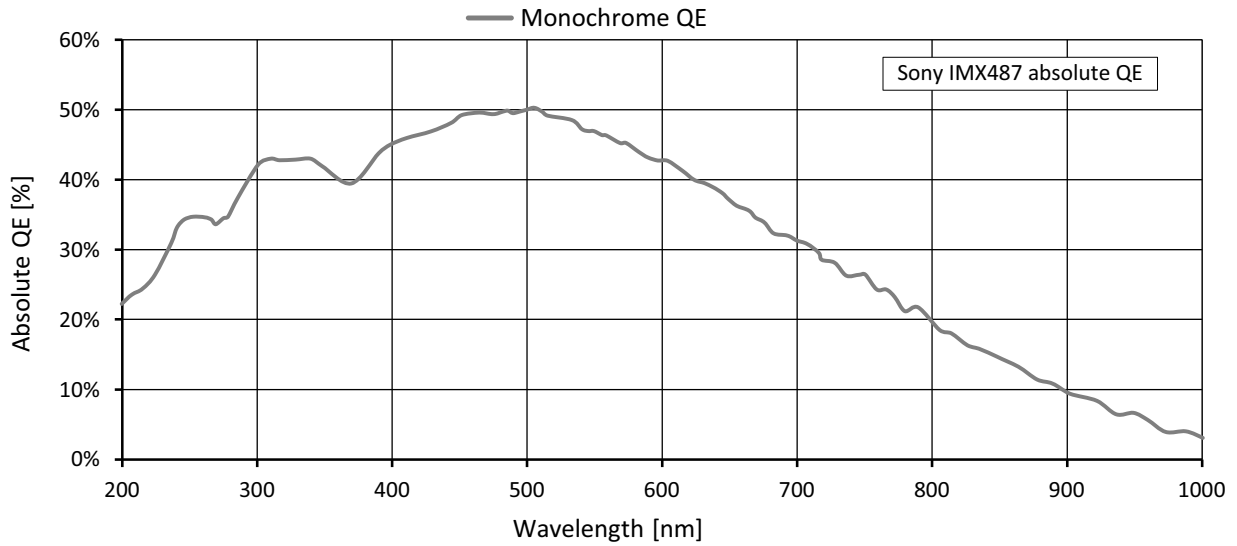

Figure 17: Alvium G5-812 UV (Sony IMX487) absolute QE

Spectral response

We intend to add a diagram in a future version of this document.

ROI frame rates

Values are based on the conditions defined in [Specified values](#) on page 52. To reach the maximum frame rate available for typical operation, the bandwidth for image traffic is 525 MByte/s.



Values for firmware V00.13.00.71d891fe

The values in [Table 46](#) were measured with firmware V00.12.00.00611a22. With higher firmware versions, the frame rates for maximum resolution will be the same, while values for lower resolutions may be lower.

Updated values will be added in a future version of this user guide.

Image format	Width [pixels]	Height [pixels]	ROI area [MP]	Frame rate [fps] ¹		
				525 MByte/s	400 MByte/s	300MByte/s
Full resolution	2848	2848	8.111	58.8/30.2	45.7/23	34.4/17.3
QSXGA	2560	2048	5.243	79.7/45.7	69.2/34.8	52/26.2
WQHD	2560	1440	3.686	109/62.7	94.7/47.8	71.2/36
QXGA	2048	1536	3.146	103.5/73.9	103.5/56.3	84.2/42.4
Full HD	1920	1080	2.074	139.6/106.2	139.6/81.1	121.2/61.2
UXGA	1600	1200	1.920	128.9/116.7	128.9/89.6	128.9/67.6
WXGA+	1440	900	1.296	162.7/162.7	162.7/125.6	162.7/94.4
SXGA	1280	1024	1.311	148.1/148	148.1/128.4	148.1/96.4
HD 720	1280	720	0.922	197.4/197.2	197.4/171.2	197.4/128.7
XGA	1024	768	0.786	188.3/188.3		188.3/153.2
SVGA	800	600	0.480	227/227		
VGA	640	480	0.307	271.4/271.4		
HVGA	480	320	0.154	358.3/358.3		
QVGA	320	240	0.077	425/425		
HQVGA	240	160	0.038	525.4/525.4		
QQVGA	160	120	0.019	579.5/579.5		
Max. × half	2848	1424	4.056	109.8/56.7	85.6/43.4	64.6/32.7
Max. × min.	2848	8	0.023	776.8/435.5	625.9/340	487.8/260.3
Min. × max.	8	2848	0.023	59.5/59.5		
Min. × min.	8	8	64 P	905.6/905.6		

¹ Mono8 or Bayer...8⁽²⁾ at `SensorBitDepth` = 12-Bit / Mono12 or Bayer...12 at `SensorBitDepth` = 12-Bit

² The three dots... represent the colors of a Bayer pixel format, such as in BayerRG8.

Table 46: Alvium G5-812 UV ROI frame rates

Alvium G5-1240m/c

Feature	Specification	
	G5-1240m	G5-1240c
Sensor model	Sony IMX226	
Resolution	4024 (H) x 3036 (V); 12.2 MP	
Sensor type	CMOS	
Shutter type	Rolling shutter (RS) or Global reset shutter (GRS)	
Sensor size	Type 1/1.7; 7.4 mm × 5.6 mm; 9.3 mm diagonal	
Pixel size	1.85 μm × 1.85 μm	
CRA	0 deg	
Sensor bit depth (ADC)	10-bit	
Monochrome pixel formats	Mono8 (default), Mono10, Mono10p, Mono12, Mono12p, Mono12Packed	Mono8, Mono10, Mono10p, Mono12, Mono12p, Mono12Packed
YUV color pixel formats	Not applicable	YCbCr411_8_CbYYCrYY, YCbCr422_8_CbYCrY, YCbCr8_CbYCr
RGB color pixel formats	Not applicable	BGR8, RGB8 (default)
Raw color pixel formats	Not applicable	BayerRG8, BayerRG10, BayerRG10p, BayerRG12, BayerRG12p, BayerRG12Packed
Maximum frame rate	41 fps ¹ (at 525 MByte/s)	
Exposure time	10 μs to 10 s (525 MByte/s)	
Exposure modes	Timed	
Gain	0 dB to 27 dB; 0.1 dB increments	
Digital binning ²	Horizontal: 1 to 8 columns; Vertical: 1 to 8 rows	
Image buffer (RAM)	512 MByte	
Non-volatile memory (Flash)	1024 KByte	
Inputs and outputs	1 opto-isolated input, 1 opto-isolated output, 2 non-isolated GPIOs	
Power requirements	12 to 24 VDC	
Power requirements (PoE)	IEEE 802.3af	
Power consumption (typical)	External power: 6.1 W at 12 VDC Power over Ethernet: 6.8 W	
Storage temperature	-20 °C to +85 °C ambient temperature	
Operating temperature	-20 °C to +60 °C (Housing), -20 °C to +88 °C (Mainboard ³)	
Humidity	0% to 80% humidity (non-condensing)	
Digital interface	5GBASE-T, 2.5GBASE-T, 1000BASE-T	
Camera controls	GenICam (GenICam Access)	
¹ In triggered mode: ~41 fps		
² Digital vertical binning can be used only when digital horizontal binning is used as well.		
³ Output by DeviceTemperature		

Table 47: Alvium G5-1240m/c specifications

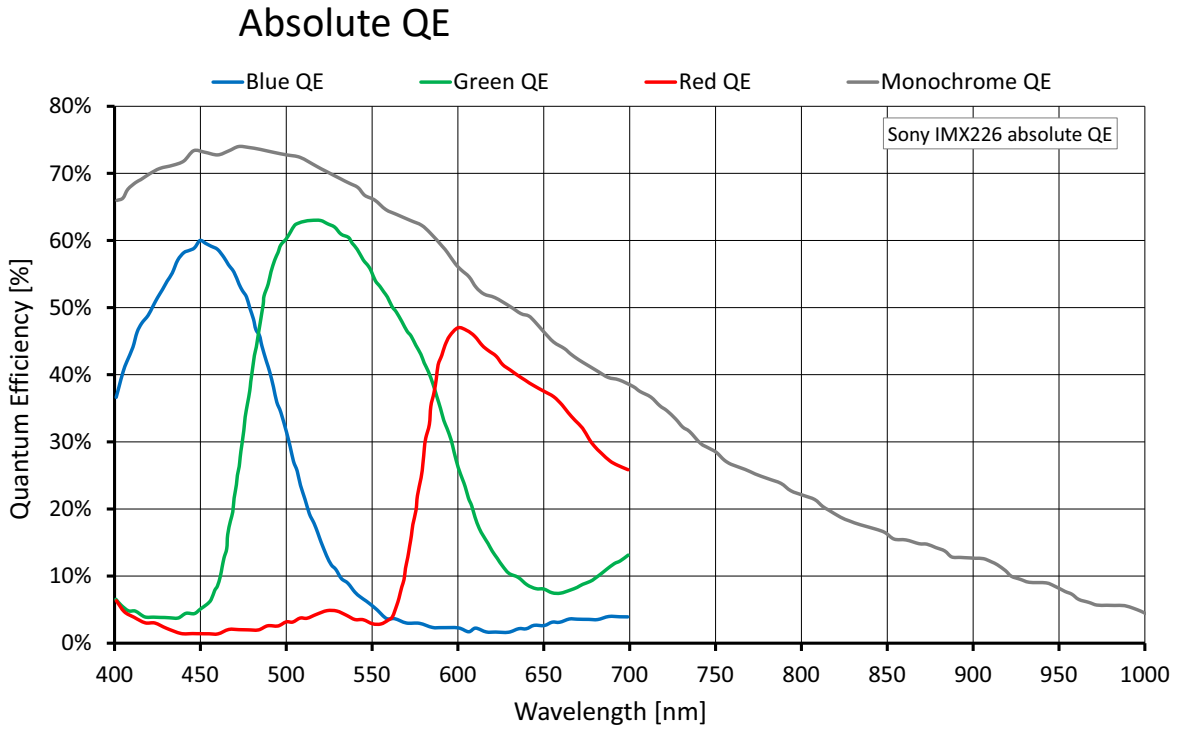

Figure 18: Alvium G5-1240m/c (Sony IMX226) absolute QE

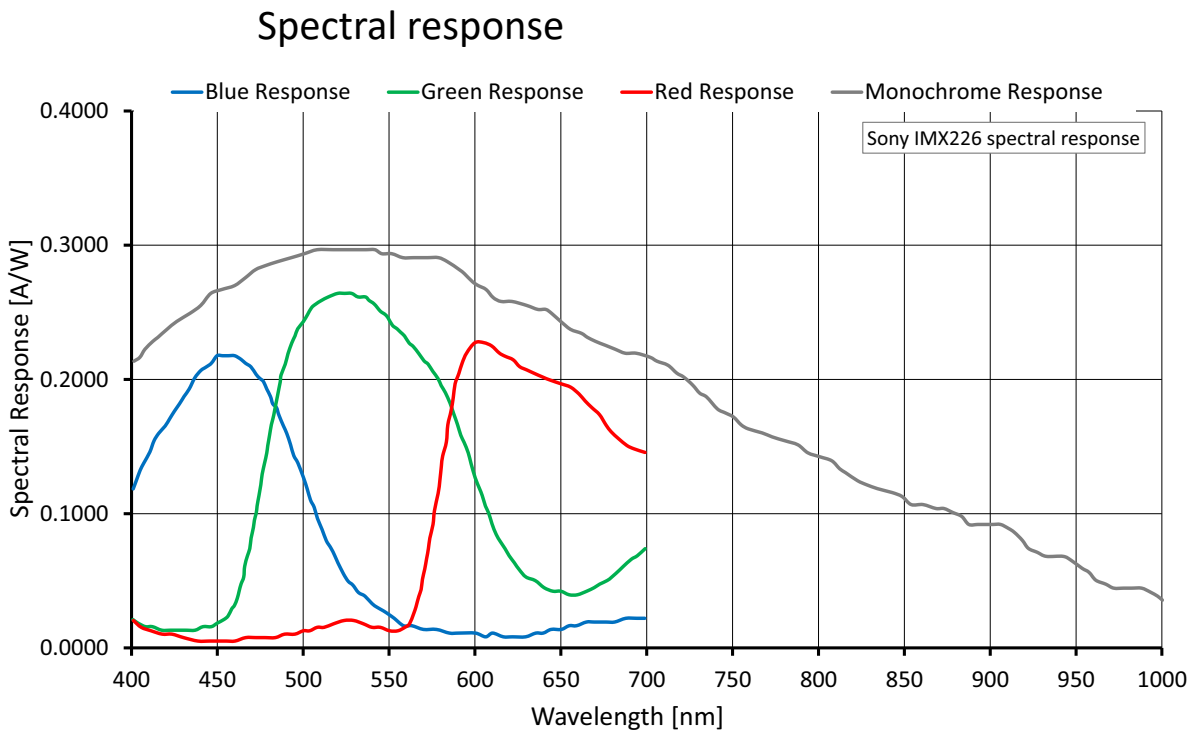

Figure 19: Alvium G5-1240m/c (Sony IMX226) spectral response

ROI frame rates

Values are based on the conditions defined in [Specified values](#) on page 52. To reach the maximum frame rate available for typical operation, the bandwidth for image traffic is 525 MByte/s.

Shutter mode	User mode	Available frame rates
Rolling shutter (RS)	Freerun	Values in Table 49 below are reached.
Rolling shutter (RS)	Triggered	>99% of the values for in Table 49 below are reached.
Global reset shutter (GRS)	Freerun	>99% of the values for in Table 49 below are reached.
Global reset shutter (GRS)	Triggered	

Table 48: Frame rate behavior for different configurations

Image format	Width [pixels]	Height [pixels]	ROI area [MP]	Frame rate [fps] ¹		
				525 MByte/s	400 MByte/s	300MByte/s
Full resolution	4024	3036	12.217	41.2 / 20.9	31.9 / 16.0	23.9 / 12.0
UHD 4K	3840	2160	8.294			
QSXGA	2560	2048	5.243			
WQHD	2560	1440	3.686			
QXGA	2048	1536	3.146			
Full HD	1920	1080	2.074			
UXGA	1600	1200	1.920			
WXGA+	1440	900	1.296			
SXGA	1280	1024	1.311			
HD 720	1280	720	0.922			
XGA	1024	768	0.786			
SVGA	800	600	0.480			
VGA	640	480	0.307			
HVGA	480	320	0.154			
QVGA	320	240	0.077			
HQVGA	240	160	0.038			
QQVGA	160	120	0.019			
Max. x half	4024	1518	6.108			
Max. x min.	4024	8	0.032			
Min. x max.	8	3036	0.024			
Min. x min.	8	8	64 P			

¹ Mono8 or Bayer...8⁽²⁾ at **SensorBitDepth** = 10-Bit / Mono10 or Bayer...10 at **SensorBitDepth** = 10-Bit

² The three dots... represent the colors of a Bayer pixel format, such as in Bayer**RG8**.

Table 49: Alvium G5-1240m/c ROI frame rates

Alvium G5-1242m/c

Feature	Specification	
	G5-1242m (monochrome)	G5-1242c (color)
Sensor model	Sony IMX545	
Resolution	4128 (H) × 3008 (V); 12.4 MP	
Sensor type	CMOS	
Shutter type	Global shutter (GS)	
Sensor size	Type 1/1.1; 11.3 mm × 8.2 mm; 14.0 mm diagonal	
Pixel size	2.74 μm × 2.74 μm	
CRA	0 deg	
Sensor bit depth (ADC)	12-bit	
Monochrome pixel formats	Mono8 (default), Mono10, Mono10p, Mono12, Mono12p, Mono12Packed	Mono8, Mono10, Mono10p, Mono12, Mono12p, Mono12Packed
YUV color pixel formats	Not applicable	YCbCr411_8_CbYYCrYY, YCbCr422_8_CbYCrY, YCbCr8_CbYCr
RGB color pixel formats	Not applicable	BGR8, RGB8 (default)
Raw color pixel formats	Not applicable	BayerRG8, BayerRG10, BayerRG10p, BayerRG12, BayerRG12p, BayerRG12Packed
Maximum frame rate	39 fps (at 525 MByte/s)	
Exposure time	11 μs to 10 s (525MByte/s)	
Exposure modes	Timed, TriggerControlled, TriggerWidth	
Gain	0 dB to 48 dB; 0.1 dB increments	
Digital binning ¹	Horizontal: 1 to 8 columns; Vertical: 1 to 8 rows	
Sensor binning (H × V)	2 × 2 (<i>Sum</i>)	Not applicable
Multiple ROI (H × V)	<i>Free Tile Horizontal</i> : 1 × 1 to 1 × 4 <i>Vertical</i> : 1 × 1 to 4 × 1	
Image buffer (RAM)	512 MByte	
Non-volatile memory (Flash)	1024 KByte	
GPIOs	1 opto-isolated input, 1 opto-isolated output, 2 non-isolated GPIOs	
Power requirements	12 to 24 VDC	
Power requirements (PoE)	IEEE 802.3af	
Power consumption (typical)	External power: 6.5 W at 12 VDC Power over Ethernet: 7.1 W	
Storage temperature	-20 °C to +85 °C ambient temperature	
Operating temperature	-20 °C to +60 °C (Housing), -20 °C to +85 °C (Mainboard ²)	
Humidity	0% to 80% humidity (non-condensing)	
Digital interface	5GBASE-T, 2.5GBASE-T, 1000BASE-T	
Camera controls	GenICam (GenICam Access)	
¹ Digital vertical binning can be used only when digital horizontal binning is used as well.		
² Output by <code>DeviceTemperature</code>		

Table 50: Alvium G5-1242m/c specifications

Absolute QE

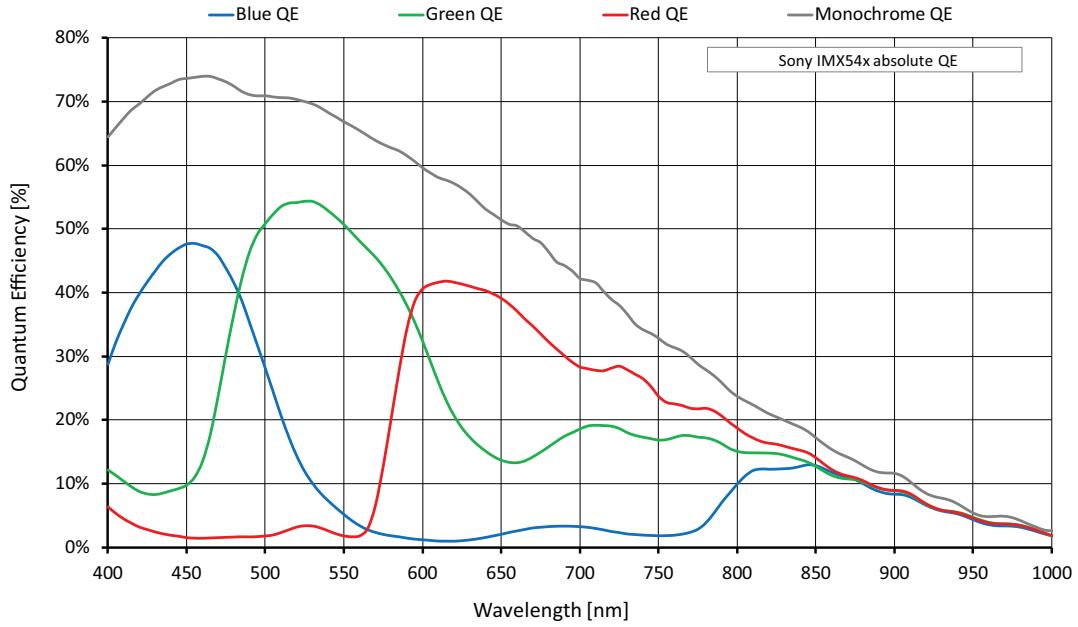

Figure 20: Alvium G5-1242m/c (Sony IMX545) absolute QE

Spectral response

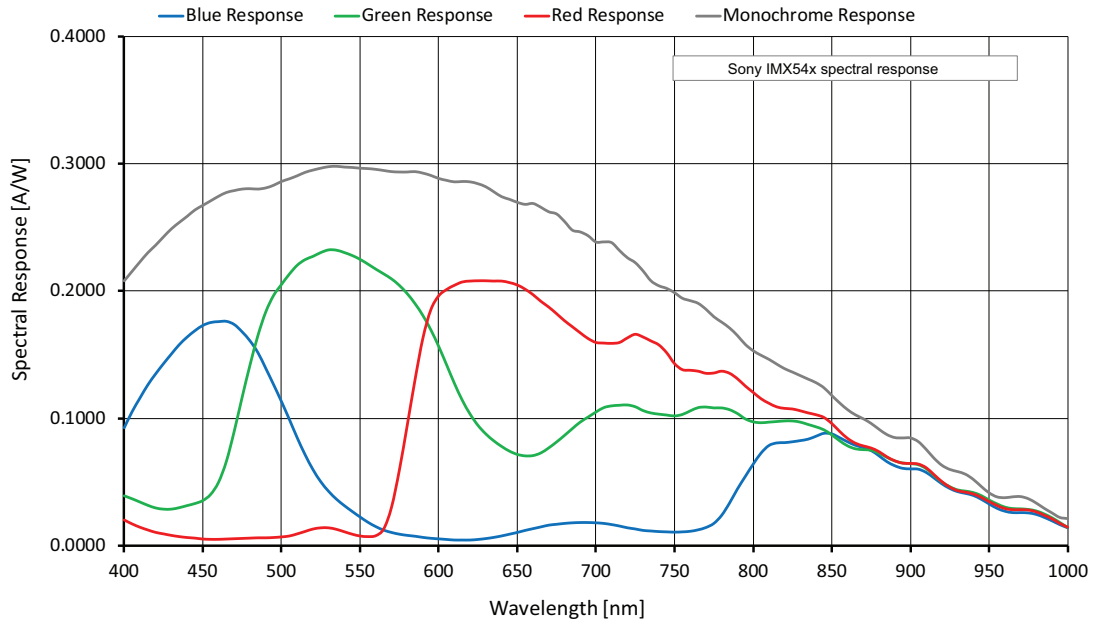

Figure 21: Alvium G5-1242m/c (Sony IMX545) spectral response

ROI frame rates

Values are based on the conditions defined in [Specified values](#) on page 52. To reach the maximum frame rate available for this setup, the bandwidth for image traffic is 525 MByte/s.



Values for firmware V00.13.00.71d891fe

The values in [Table 51](#) were measured with firmware V00.12.00.00611a22. With higher firmware versions, the frame rates for maximum resolution will be the same, while values for lower resolutions may be lower.

Updated values will be added in a future version of this user guide.

Image format	Width [pixels]	Height [pixels]	ROI area [MP]	Frame rate [fps] ¹		
				525 MByte/s	400 MByte/s	300MByte/s
Full resolution	4128	3008	12.417	39.8/20.0	30.4/15.3	22.8/11.5
UHD 4K	3840	2160	8.294	55.8/29.4	44.4/22.4	33.5/16.9
QSXGA	2560	2048	5.243	59.0/46.4	59.0/35.4	52.8/26.6
WQHD	2560	1440	3.686	81.3/64.0	81.3/48.8	72.8/36.8
QXGA	2048	1536	3.146	77.0/75.4	77.0/57.4	77.0/43.3
Full HD	1920	1080	2.074	105.5/105.4	105.5/83.9	105.5/63.3
UXGA	1600	1200	1.920	96.4/96.4	96.4/91.9	96.4/69.4
WXGA+	1440	900	1.296	123.5/123.5		123.5/98.2
SXGA	1280	1024	1.311	111.1/111.1		111.1/99.3
HD 720	1280	720	0.922	149.9/149.9		149.9/134.0
XGA	1024	768	0.786	142.5/142.5		
SVGA	800	600	0.480	174.9/174.9		
VGA	640	480	0.307	209.1/209.1		
HVGA	480	320	0.154	281.1/281.1		
QVGA	320	240	0.077	339.5/339.5		
HQVGA	240	160	0.038	428.5/428.5		
QQVGA	160	120	0.019	493.2/493.2		
Max. x half	4128	1504	6.209	75.4/38.2	57.7/29.2	43.4/21.9
Max. x min.	4128	8	0.033	669.1/378.3	540.0/297.3	424.0/229.9
Min. x max.	8	3008	0.024	41.4/41.4		
Min. x min.	8	8	64 P	859.9/854.3		

¹ Mono8 or Bayer...8⁽²⁾ at **SensorBitDepth** = 12-Bit / Mono12 or Bayer...12 at **SensorBitDepth** = 12-Bit

² The three dots... represent the colors of a Bayer pixel format, such as in BayerRG8.

Table 51: Alvium G5-1242m/c ROI frame rates

Alvium G5-1620m/c

Feature	Specification	
	G5-1620m	G5-1620c
Sensor model	Sony IMX542	
Resolution	5328 (H) × 3040 (V); 16.2 MP	
Sensor type	CMOS	
Shutter type	Global shutter (GS)	
Sensor size	Type 1.1; 14.6 mm × 8.3 mm; 16.8 mm diagonal	
Pixel size	2.74 μm × 2.74 μm	
CRA	0 deg	
Sensor bit depth (ADC)	12-bit	
Monochrome pixel formats	Mono8 (default), Mono10, Mono10p, Mono12, Mono12p, Mono12Packed	Mono8, Mono10, Mono10p, Mono12, Mono12p, Mono12Packed
YUV color pixel formats	Not applicable	YCbCr411_8_CbYYCrYY, YCbCr422_8_CbYCrY, YCbCr8_CbYCr
RGB color pixel formats	Not applicable	BGR8, RGB8 (default)
Raw color pixel formats	Not applicable	BayerRG8, BayerRG10, BayerRG10p, BayerRG12, BayerRG12p, BayerRG12Packed
Maximum frame rate	30 fps (at 525 MByte/s)	
Exposure time	13 μs to 10 s (525 MByte/s)	
Exposure modes	Timed, TriggerControlled, TriggerWidth	
Gain	0 dB to 48 dB; 0.1 dB increments	
Digital binning ¹	Horizontal: 1 to 8 columns; Vertical: 1 to 8 rows	
Sensor binning (H × V)	2 × 2 (<i>Sum</i>)	Not applicable
Multiple ROI (H × V)	<i>Free Tile Horizontal</i> : 1 × 1 to 1 × 4 <i>Vertical</i> : 1 × 1 to 4 × 1	
Image buffer (RAM)	512 MByte	
Non-volatile memory (Flash)	1024 KByte	
Inputs and outputs	1 opto-isolated input, 1 opto-isolated output, 2 non-isolated GPIOs	
Power requirements	12 to 24 VDC	
Power requirements (PoE)	IEEE 802.3af	
Power consumption (typical)	External power: 7.0 W at 12 VDC Power over Ethernet: 7.5 W	
Storage temperature	-20 °C to +85 °C ambient temperature	
Operating temperature	-20 °C to +60 °C (Housing), -20 °C to +85 °C (Mainboard ²)	
Humidity	0% to 80% humidity (non-condensing)	
Digital interface	5GBASE-T, 2.5GBASE-T, 1000BASE-T	
Camera controls	GenICam (GenICam Access)	

¹ Digital vertical binning can be used only when digital horizontal binning is used as well.

² Output by `DeviceTemperature`

Table 52: Alvium G5-1620m/c specifications

Absolute QE

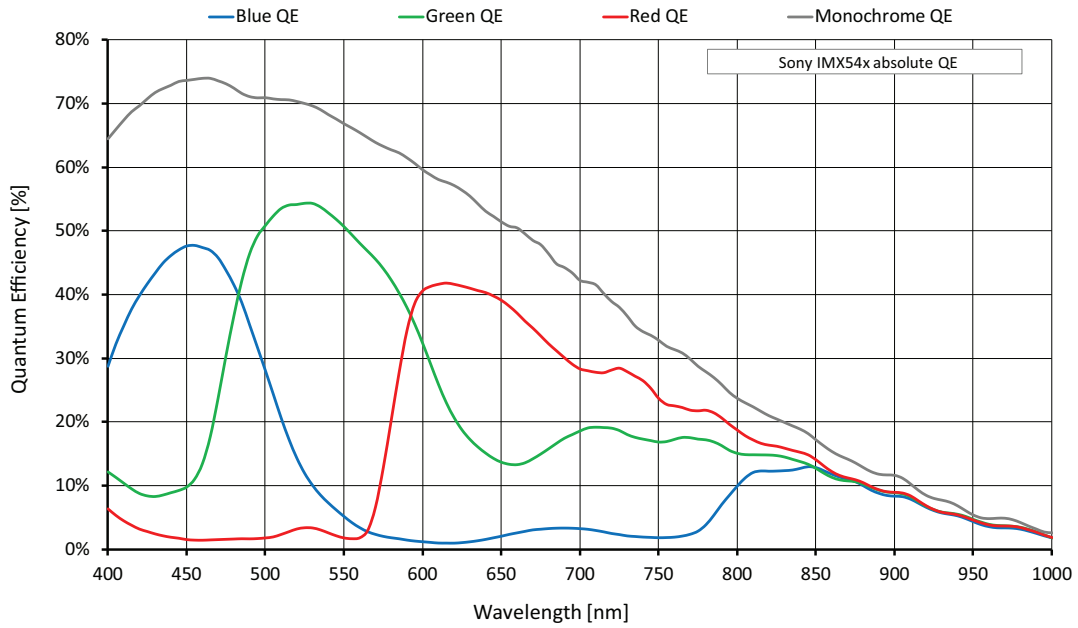

Figure 22: Alvium G5-1620m/c (Sony IMX542) absolute QE

Spectral response

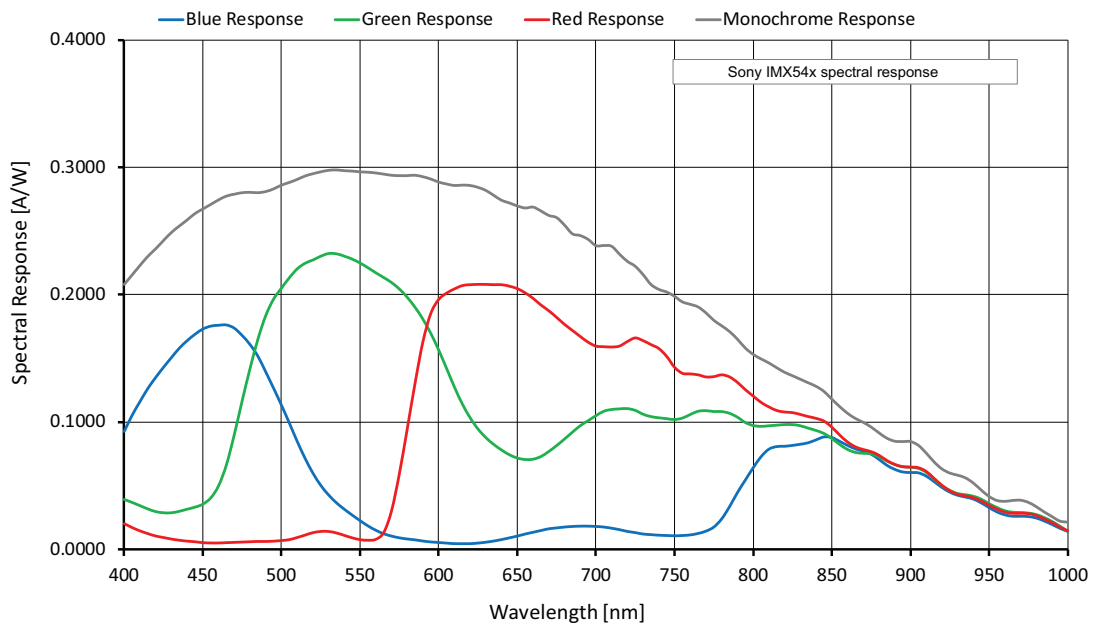

Figure 23: Alvium G5-1620m/c (Sony IMX542) spectral response

ROI frame rates

Values are based on the conditions defined in [Specified values](#) on page 52. To reach the maximum frame rate available for typical operation, the bandwidth for image traffic is 525 MByte/s.

Image format	Width [pixels]	Height [pixels]	ROI area [MP]	Frame rate [fps] ¹		
				525 MByte/s	400 MByte/s	300MByte/s
Full resolution	5328	3040	16.197	30.7/15.5	24.1/12.0	18.1/9.0
UHD 4K	3840	2160	8.294	44.6/29.7	44.6/23.5	35.3/17.6
QSXGA	2560	2048	5.243	47.1/46.9	47.1/37.2	47.1/27.9
WQHD	2560	1440	3.686	65.3/64.9	65.3/52.9	65.3/39.7
QXGA	2048	1536	3.146	61.7/61.7		61.7/46.5
Full HD	1920	1080	2.074	84.9/84.9		84.9/70.5
UXGA	1600	1200	1.92	77.4/77.4		77.4/76.1
WXGA+	1440	900	1.296	99.7/99.6		99.7/99.6
SXGA	1280	1024	1.311	89.4/89.4		
HD 720	1280	720	0.922	121.5/121.5		
XGA	1024	768	0.786	115.2/115.2		
SVGA	800	600	0.48	142.2/142.2		
VGA	640	480	0.307	171.0/171.0		
HVGA	480	320	0.154	232.8/232.8		
QVGA	320	240	0.077	284.1/284.1		
HQVGA	240	160	0.038	364.4/364.4		
QQVGA	160	120	0.019	424.4/424.4		
Max. × half	5328	1520	8.099	58.4/29.7	48.1/24.1	36.1/18.1
Max. × min.	5328	8	0.043	581.1/332.7		
Min. × max.	8	3040	0.024	32.6/32.6		
Min. × min.	8	8	64 P	787.2/787.2		

¹ Mono8 or Bayer...8⁽²⁾ at **SensorBitDepth** = 12-Bit / Mono12 or Bayer...12 at **SensorBitDepth** = 12-Bit

² The three dots... represent the colors of a Bayer pixel format, such as in Bayer**RG8**.

Table 53: Alvium G5-1620m/c ROI frame rates

Alvium G5-2040m/c

Feature	Specification	
	G5-2040m (monochrome)	G5-2040c (color)
Sensor model	Sony IMX541	
Resolution	4512 (H) × 4512 (V); 20.4 MP	
Sensor type	CMOS	
Shutter type	Global shutter (GS)	
Sensor size	Type 1.1; 12.4 mm × 12.4 mm; 17.5 mm diagonal	
Pixel size	2.74 μm × 2.74 μm	
CRA	0 deg	
Sensor bit depth (ADC)	12-bit	
Monochrome pixel formats	Mono8 (default), Mono10, Mono10p, Mono12, Mono12p, Mono12Packed	Mono8, Mono10, Mono10p, Mono12, Mono12p, Mono12Packed
YUV color pixel formats	Not applicable	YCbCr411_8_CbYYCrYY, YCbCr422_8_CbYCrY, YCbCr8_CbYCr
RGB color pixel formats	Not applicable	BGR8, RGB8 (default)
Raw color pixel formats	Not applicable	BayerRG8, BayerRG10, BayerRG10p, BayerRG12, BayerRG12p, BayerRG12Packed
Maximum frame rate	24 fps (at 525 MByte/s)	
Exposure time	12 μs to 10 s (525 MByte/s)	
Exposure modes	Timed, TriggerControlled, TriggerWidth	
Gain	0 dB to 48 dB; 0.1 dB increments	
Digital binning ¹	Horizontal: 1 to 8 columns; Vertical: 1 to 8 rows	
Sensor binning (H × V)	2 × 2 (<i>Sum</i>)	Not applicable
Multiple ROI (H × V)	<i>Free Tile Horizontal</i> : 1 × 1 to 1 × 4 <i>Vertical</i> : 1 × 1 to 4 × 1	
Image buffer (RAM)	512 MByte	
Non-volatile memory (Flash)	1024 KByte	
GPIOs	1 opto-isolated input, 1 opto-isolated output, 2 non-isolated GPIOs	
Power requirements	12 to 24 VDC	
Power requirements (PoE)	IEEE 802.3af	
Power consumption (typical)	External power: 6.9 W at 12 VDC Power over Ethernet: 7.6 W	
Storage temperature	-20 °C to +85 °C ambient temperature	
Operating temperature	-20 °C to +55 °C (Housing), -20 °C to +85 °C (Mainboard ²)	
Humidity	0% to 80% humidity (non-condensing)	
Digital interface	5GBASE-T, 2.5GBASE-T, 1000BASE-T	
Camera controls	GenICam (GenICam Access)	
¹ Digital vertical binning can be used only when digital horizontal binning is used as well.		
² Output by <code>DeviceTemperature</code>		

Table 54: Alvium G5-2040m/c specifications

Absolute QE

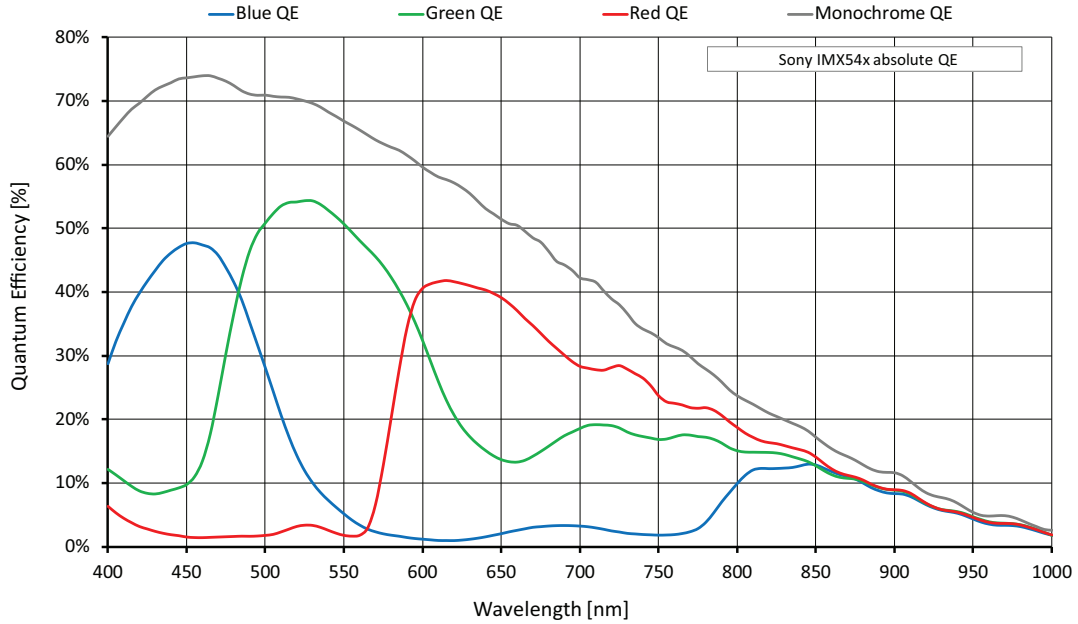

Figure 24: Alvium G5-2040m/c (Sony IMX541) absolute QE

Spectral response

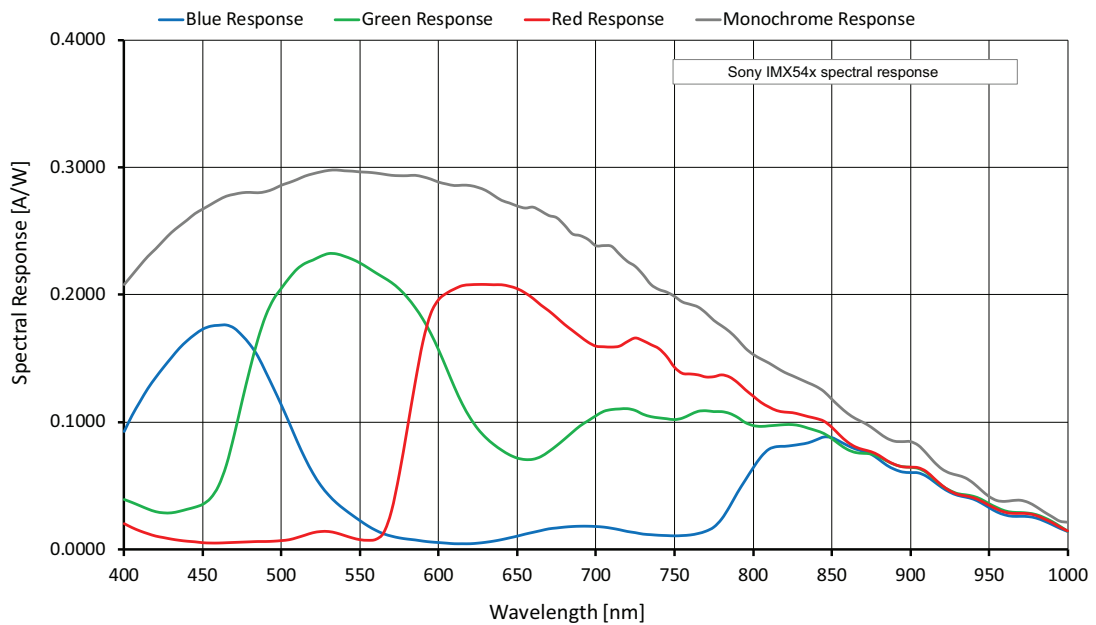

Figure 25: Alvium G5-2040m/c (Sony IMX541) spectral response

ROI frame rates

Values are based on the conditions defined in [Specified values](#) on page 52. To reach the maximum frame rate available for this setup, the bandwidth for image traffic is 525 MByte/s.

Image format	Width [pixels]	Height [pixels]	ROI area [MP]	Frame rate [fps] ¹		
				525 MByte/s	400 MByte/s	300MByte/s
Full resolution	4512	4512	20.358	24.8/12.5	19.2/9.6	14.4/7.2
HXGA	4096	3072	12.583	37.3/19.9	31.0/15.5	23.2/11.6
UHD 4K	3840	2160	8.294	52.0/29.6	47.0/23.5	35.3/17.6
QSXGA	2560	2048	5.243	55.0/46.8	55.0/37.2	55.0/27.9
WQHD	2560	1440	3.686	76.0/64.8	76.0/52.9	76.0/39.7
QXGA	2048	1536	3.146	71.9/71.9	71.9/62.0	71.9/46.5
Full HD	1920	1080	2.074	98.9/98.8	98.9/93.9	98.9/70.5
UXGA	1600	1200	1.92	90.2/90.2		90.2/76.1
WXGA+	1440	900	1.296	116.0/116.0		116.0/112.8
SXGA	1280	1024	1.311	104.2/104.2		
HD 720	1280	720	0.922	141.3/141.3		
XGA	1024	768	0.786	134.2/134.2		
SVGA	800	600	0.48	165.6/165.6		
VGA	640	480	0.307	198.9/198.9		
HVGA	480	320	0.154	270.3/270.3		
QVGA	320	240	0.077	329.3/329.3		
HQVGA	240	160	0.038	421.4/421.4		
QQVGA	160	120	0.019	490.0/490.0		
Max. × half	4512	2256	10.179	47.9/24.3	38.3/19.1	28.7/14.4
Max. × min.	4512	8	0.036	674.5/390.5		
Min. × max.	8	4512	0.036	26.0/26.0		
Min. × min.	8	8	64 P	899.5/899.5		

¹ Mono8 or Bayer...8⁽²⁾ at **SensorBitDepth** = 12-Bit / Mono12 or Bayer...12 at **SensorBitDepth** = 12-Bit

² The three dots... represent the colors of a Bayer pixel format, such as in Bayer**RG8**.

Table 55: Alvium G5-2040m/c ROI frame rates

Alvium G5/G5X-2050m/c



Firmware version for Alvium G5X models

While Alvium G5 models are supported by the latest firmware version, Alvium G5X models require FW 00.12.00.00611a22. A future common firmware version will support G5 and G5X.

Feature	Specification	
	G5/G5X-2050m (monochrome)	G5/G5X-2050c (color)
Sensor model	Sony IMX183	
Resolution	5496 (H) × 3672 (V); 20.2 MP	
Sensor type	CMOS	
Shutter type	Rolling shutter (RS), Global reset shutter (GRS)	
Sensor size	Type 1; 13.1 mm × 8.8 mm; 15.9 mm diagonal	
Pixel size	2.4 μm × 2.4 μm	
CRA	3 deg	
Sensor bit depth (ADC)	10-bit	
Monochrome pixel formats	Mono8 (default), Mono10, Mono10p, Mono12, Mono12p, Mono12Packed	Mono8, Mono10, Mono10p, Mono12, Mono12p, Mono12Packed
YUV color pixel formats	Not applicable	YCbCr411_8_CbYYCrYY, YCbCr422_8_CbYCrY, YCbCr8_CbYCr
RGB color pixel formats	Not applicable	BGR8, RGB8 (default)
Raw color pixel formats	Not applicable	BayerRG8, BayerRG10, BayerRG10p, BayerRG12, BayerRG12p, BayerRG12Packed
Maximum frame rate	25 fps ¹ (at 525 MByte/s)	
Exposure time	13 μs to 10 s (525 MByte/s)	
Exposure modes	Timed	
Gain	0 dB to 27 dB; 0.1 dB increments	
Digital binning ²	Horizontal: 1 to 8 columns; Vertical: 1 to 8 rows	
Image buffer (RAM)	512 MByte	
Non-volatile memory (Flash)	1024 KByte	
Inputs and outputs	1 opto-isolated input, 1 opto-isolated output, 2 non-isolated GPIOs	
Power requirements	12 to 24 VDC	
Power requirements (PoE)	IEEE 802.3af	
Power consumption (typical)	G5: External power: 6.5 W at 12 VDC Power over Ethernet: 7.0 W G5X: External power: 6.8 W at 12 VDC Power over Ethernet: 7.3 W	

¹ In triggered mode: ~25 fps

² Digital vertical binning can be used only when digital horizontal binning is used as well.

Table 56: Alvium G5/G5X-2050m/c specifications (sheet 1 of 2)

Feature	Specification	
	G5/G5X-2050m (monochrome)	G5/G5X-2050c (color)
Storage temperature	-20 °C to +85 °C ambient temperature	
Operating temperature	G5 : -20 °C to +60 °C (Housing), -20 °C to +88 °C (Mainboard ³) G5X : -20 °C to +55 °C (Housing), -20 °C to +88 °C (Mainboard ³)	
Humidity	0% to 80% humidity (non-condensing)	
Digital interface	5GBASE-T, 2.5GBASE-T, 1000BASE-T	
Camera controls	GenICam (GenICam Access)	
³ Output by DeviceTemperature		

Table 56: Alvium G5/G5X-2050m/c specifications (sheet 2 of 2)

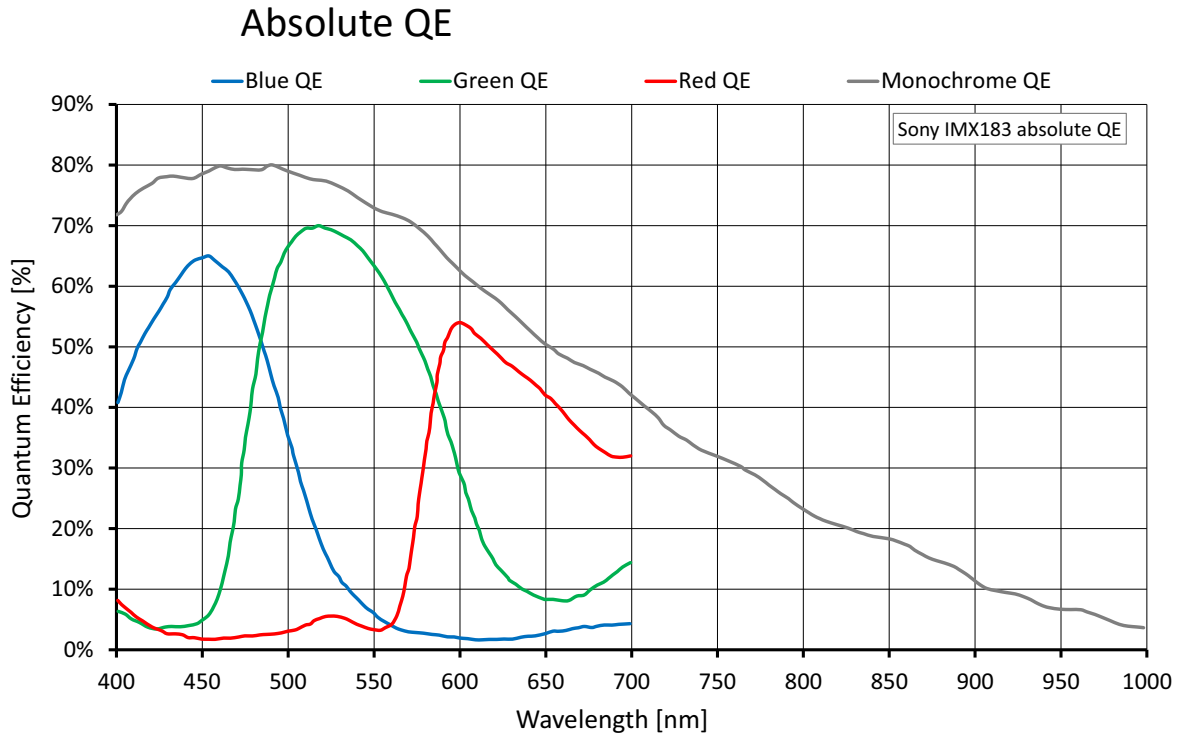

Figure 26: Alvium G5/G5X-2050m/c (Sony IMX183) absolute QE

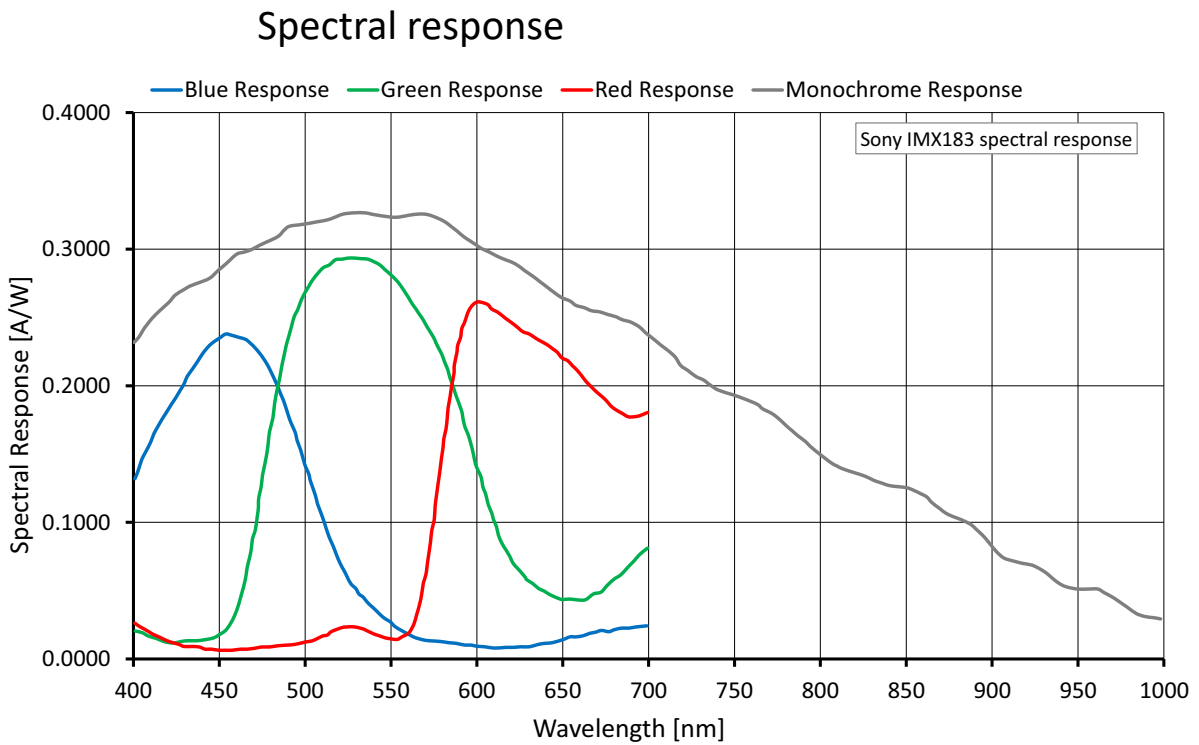

Figure 27: Alvium G5/G5X-2050m/c (Sony IMX183) spectral response

ROI frame rates

Values are based on the conditions defined in [Specified values](#) on page 52. To reach the maximum frame rate available for typical operation, the bandwidth for image traffic is 525 MByte/s.

Shutter mode	User mode	Available frame rates
Rolling shutter (RS)	Freerun	Values in Table 58 below are reached.
Rolling shutter (RS)	Triggered	>99% of the values for in Table 58 below are reached.
Global reset shutter (GRS)	Freerun	>99% of the values for in Table 58 below are reached.
Global reset shutter (GRS)	Triggered	

Table 57: Frame rate behavior for different configurations

Image format	Width [pixels]	Height [pixels]	ROI area [MP]	Frame rate [fps] ¹		
				525 MByte/s	400 MByte/s	300MByte/s
Full resolution	5496	3672	20.181	25.1/12.7	19.3/9.7	14.5/7.2
HXGA	4096	3072	12.583	29.8/15.1		23.2/11.6
UHD 4K	3840	2160	8.294	41.7/21.1		35.2/17.6
QSXGA	2560	2048	5.243	43.9/22.2		
WQHD	2560	1440	3.686	48.4/24.5		
QXGA	2048	1536	3.146			
Full HD	1920	1080	2.074			
UXGA	1600	1200	1.92			
WXGA+	1440	900	1.296			
SXGA	1280	1024	1.311			
HD 720	1280	720	0.922			
XGA	1024	768	0.786			
SVGA	800	600	0.48			
VGA	640	480	0.307			
HVGA	480	320	0.154			
QVGA	320	240	0.077			
HQVGA	240	160	0.038			
QQVGA	160	120	0.019			
Max. × half	5496	1836	10.091	48.3/24.5	38.6/19.3	29.0/14.5
Max. × min.	5496	8	0.044	48.4/24.5		
Min. × max.	8	3672	0.029	25.1/12.7		
Min. × min.	8	8	64 P	48.4/24.5		

¹ Mono8 or Bayer...8⁽²⁾ at **SensorBitDepth** = 10-Bit / Mono10 or Bayer...10 at **SensorBitDepth** = 10-Bit

² The three dots... represent the colors of a Bayer pixel format, such as in Bayer**RG8**.

Table 58: Alvium G5/G5X-2050m/c ROI frame rates

Alvium G5/G5X-2460m/c



Firmware version for Alvium G5X models

While Alvium G5 models are supported by the latest firmware version, Alvium G5X models require FW 00.12.00.00611a22. A future common firmware version will support G5 and G5X.

Feature	Specification	
	G5/G5X-2460m	G5/G5X-2460c
Sensor model	Sony IMX540	
Resolution	5328 (H) × 4608 (V); 24.6 MP	
Sensor type	CMOS	
Shutter type	Global shutter (GS)	
Sensor size	Type 1.2; 14.6 mm × 12.6 mm; 19.3 mm diagonal	
Pixel size	2.74 μm × 2.74 μm	
CRA	0 deg	
Sensor bit depth (ADC)	12-bit	
Monochrome pixel formats	Mono8 (default), Mono10, Mono10p, Mono12, Mono12p, Mono12Packed	Mono8, Mono10, Mono10p, Mono12, Mono12p, Mono12Packed
YUV color pixel formats	Not applicable	YCbCr411_8_CbYYCrYY, YCbCr422_8_CbYCrY, YCbCr8_CbYCr
RGB color pixel formats	Not applicable	BGR8, RGB8 (default)
Raw color pixel formats	Not applicable	BayerRG8, BayerRG10, BayerRG10p, BayerRG12, BayerRG12p, BayerRG12Packed
Maximum frame rate	20 fps (at 525 MByte/s)	
Exposure time	13 μs to 10 s (525 MByte/s)	
Exposure modes	Timed, TriggerControlled, TriggerWidth	
Gain	0 dB to 48 dB; 0.1 dB increments	
Digital binning ¹	Horizontal: 1 to 8 columns; Vertical: 1 to 8 rows	
Sensor binning (H × V)	2 × 2 (Sum)	Not applicable
Multiple ROI (H × V)	Free Tile Horizontal: 1 × 1 to 1 × 4 Vertical: 1 × 1 to 4 × 1	
Image buffer (RAM)	512 MByte	
Non-volatile memory (Flash)	1024 KByte	
Inputs and outputs	1 opto-isolated input, 1 opto-isolated output, 2 non-isolated GPIOs	
Power requirements	12 to 24 VDC	
Power requirements (PoE)	IEEE 802.3af	

¹ Digital vertical binning can be used only when digital horizontal binning is used as well.

Table 59: Alvium G5/G5X-2460m/c specifications (sheet 1 of 2)

Feature	Specification	
	G5/G5X-2460m	G5/G5X-2460c
Power consumption (typical)	G5: External power: 6.9 W at 12 VDC Power over Ethernet: 7.7 W G5X: External power: 7.2 W at 12 VDC Power over Ethernet: 8.0 W	
Storage temperature	-20 °C to +85 °C ambient temperature	
Operating temperature	G5: -20 °C to +60 °C (Housing), -20 °C to +85 °C (Mainboard ²) G5X: -20 °C to +55 °C (Housing), -20 °C to +85 °C (Mainboard ²)	
Humidity	0% to 80% humidity (non-condensing)	
Digital interface	5GBASE-T, 2.5GBASE-T, 1000BASE-T	
Camera controls	GenICam (GenICam Access)	
² Output by DeviceTemperature		

Table 59: Alvium G5/G5X-2460m/c specifications (sheet 2 of 2)

Absolute QE

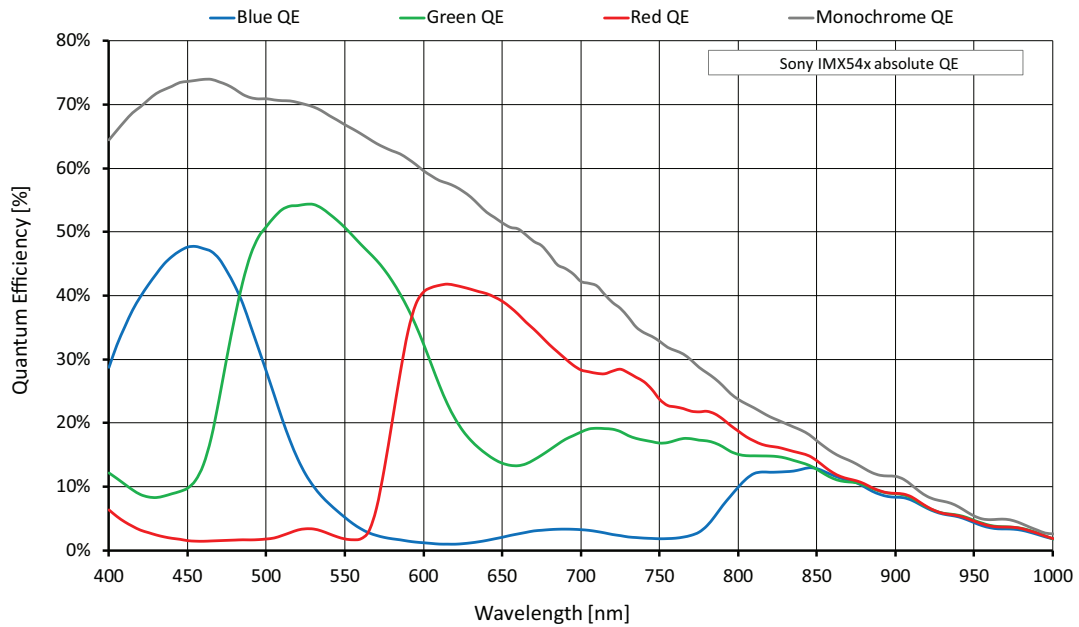

Figure 28: Alvium G5/G5X-2460m/c (Sony IMX540) absolute QE

Spectral response

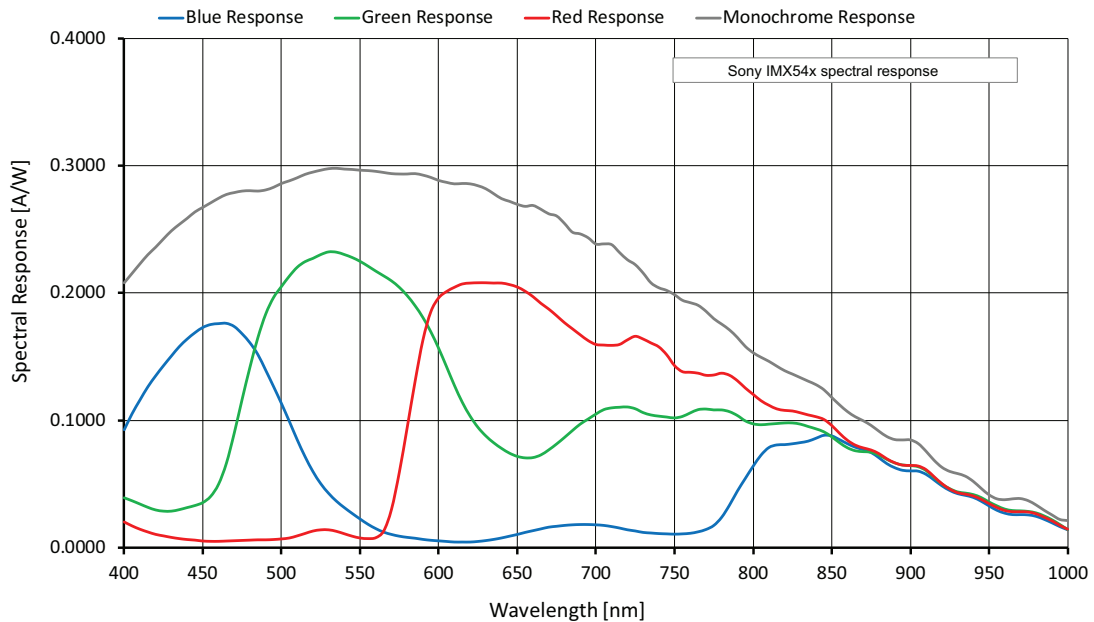

Figure 29: Alvium G5/G5X-2460m/c (Sony IMX540) spectral response

ROI frame rates



Frame rate values

Values in [Table 60](#) were measured with FW V00.12.00.00611a22. Frame rates below maximum resolution have been reduced with FW V00.13.00.71d891fe. Measurements will be published in a future version of this document.

Values are based on the conditions defined in [Specified values](#) on page 52. To reach the maximum frame rate available for typical operation, the bandwidth for image traffic is 525 MByte/s.

Image format	Width [pixels]	Height [pixels]	ROI area [MP]	Frame rate [fps] ¹		
				525 MByte/s	400 MByte/s	300MByte/s
Full resolution	5328	4608	24.551	20.5/10.3	15.7/7.9	11.8/5.9
HSXGA	5120	4096	20.972	24.0/12.1	18.3/9.2	13.8/6.9
HXGA	4096	3072	12.583	31.9/19.9	30.1/15.1	22.7/11.4
UHD 4K	3840	2160	8.294	44.6/29.6	44.6/22.6	33.8/17.0
QSXGA	2560	2048	5.243	47.1/46.8	47.1/35.7	47.1/26.8
WQHD	2560	1440	3.686	65.2/64.9	65.2/49.5	65.2/37.2
QXGA	2048	1536	3.146	61.7/61.6	61.7/58.1	61.7/43.8
Full HD	1920	1080	2.074	84.8/84.8		84.8/64.4
UXGA	1600	1200	1.920	77.4/77.4		77.4/70.4
WXGA+	1440	900	1.296	99.7/99.6		
SXGA	1280	1024	1.311	89.4/89.4		
HD 720	1280	720	0.922	121.4/121.4		
XGA	1024	768	0.786	115.2/115.2		
SVGA	800	600	0.480	142.2/142.2		
VGA	640	480	0.307	171.0/171.0		
HVGA	480	320	0.154	232.7/232.7		
QVGA	320	240	0.077	284.0/284.0		

¹ Mono8 or Bayer...8⁽²⁾ at `SensorBitDepth` = 12-Bit /
Mono12 or Bayer...12 at `SensorBitDepth` = 12-Bit

² The three dots... represent the colors of a Bayer pixel format, such as in Bayer**RG8**.

Table 60: Alvim G5/G5X-2460m/c ROI frame rates (sheet 1 of 2)

Image format	Width [pixels]	Height [pixels]	ROI area [MP]	Frame rate [fps] ¹		
				525 MByte/s	400 MByte/s	300MByte/s
HQVGA	240	160	0.038	364.3/364.3		
QQVGA	160	120	0.019	424.3/424.3		
Max. × half	5328	2304	12.276	39.8/20.1	30.4/15.3	22.9/11.5
Max. × min.	5328	8	0.043	581.1/332.6	470.7/264.0	374.9/204.1
Min. × max.	8	4608	0.037	21.7/21.7		
Min. × min.	8	8	64 P	787.2/787.2		

¹ Mono8 or Bayer...8⁽²⁾ at **SensorBitDepth** = 12-Bit /
 Mono12 or Bayer...12 at **SensorBitDepth** = 12-Bit

² The three dots... represent the colors of a Bayer pixel format, such as in Bayer**RG8**.

Table 60: Alvium G5/G5X-2460m/c ROI frame rates (sheet 2 of 2)

White balance default

Alvium G5/G5X color cameras are balanced for neutral color reproduction with an illumination of 5000 °K (warm daylight). [Table 61](#) shows default values for the red and blue channel by model.

For different illuminations, use auto white balance or adapt the color channel values manually.



Feature descriptions and firmware downloads

Alvium Features Reference: www.alliedvision.com/en/support/technical-documentation/alvium-gige-documentation

Firmware downloads: www.alliedvision.com/en/support/firmware-downloads.

Alvium G5/G5X model	Sensor model	Red channel value	Blue channel value
Alvium G5-052c	Sony IMX426	2.290	2.000
Alvium G5-203c	Sony IMX422	2.290	2.000
Alvium G5-240c	Sony IMX392	2.355	2.100
Alvium G5-291c	Sony IMX421	2.290	2.000
Alvium G5-500c	ON Semiconductor AR0521SR	2.120	1.520
Alvium G5-507c Pol	Sony IMX250MYR	Not applicable	
Alvium G5-508c	Sony IMX250	2.355	2.100
Alvium G5-508c Pol	Sony IMX264MYR	Not applicable	
Alvium G5-510c	Sony IMX548	2.870	2.000
Alvium G5-511c	Sony IMX547	2.870	2.000
Alvium G5-811c	Sony IMX546	2.870	2.000
Alvium G5-1240c	Sony IMX226	2.620	1.810
Alvium G5-1242c	Sony IMX545	2.870	2.000
Alvium G5-1620c	Sony IMX542	2.870	2.000
Alvium G5-2040c	Sony IMX541	2.870	2.000
Alvium G5/G5X-2050c	Sony IMX183	2.660	1.830
Alvium G5/G5X-2460c	Sony IMX540	2.870	2.000

Table 61: Alvium G5/G5X default values for color channels



Excluded models

White balance default does not apply to monochrome and Pol models.

Dimensions and mass

Feature	C-Mount	CS-Mount	S-Mount
Flange focal distance, optical [mm]	17.526	12.526	12.63
Thread [mm]	1"-32tpi UNS-2B	1"-32tpi UNS-2B	M12 × 0.5
Maximum protrusion ¹ [mm]	13.6	8.6	11.0
Body dimensions (L × W × H [mm])	60 × 29 × 29	55 × 29 × 29	55 × 29 × 29
Mass	100 g	100 g	100 g

¹ For details, see [Lens mounts and maximum protrusion](#) on page 126.

Table 62: Dimensions and mass

Technical drawings

C-Mount

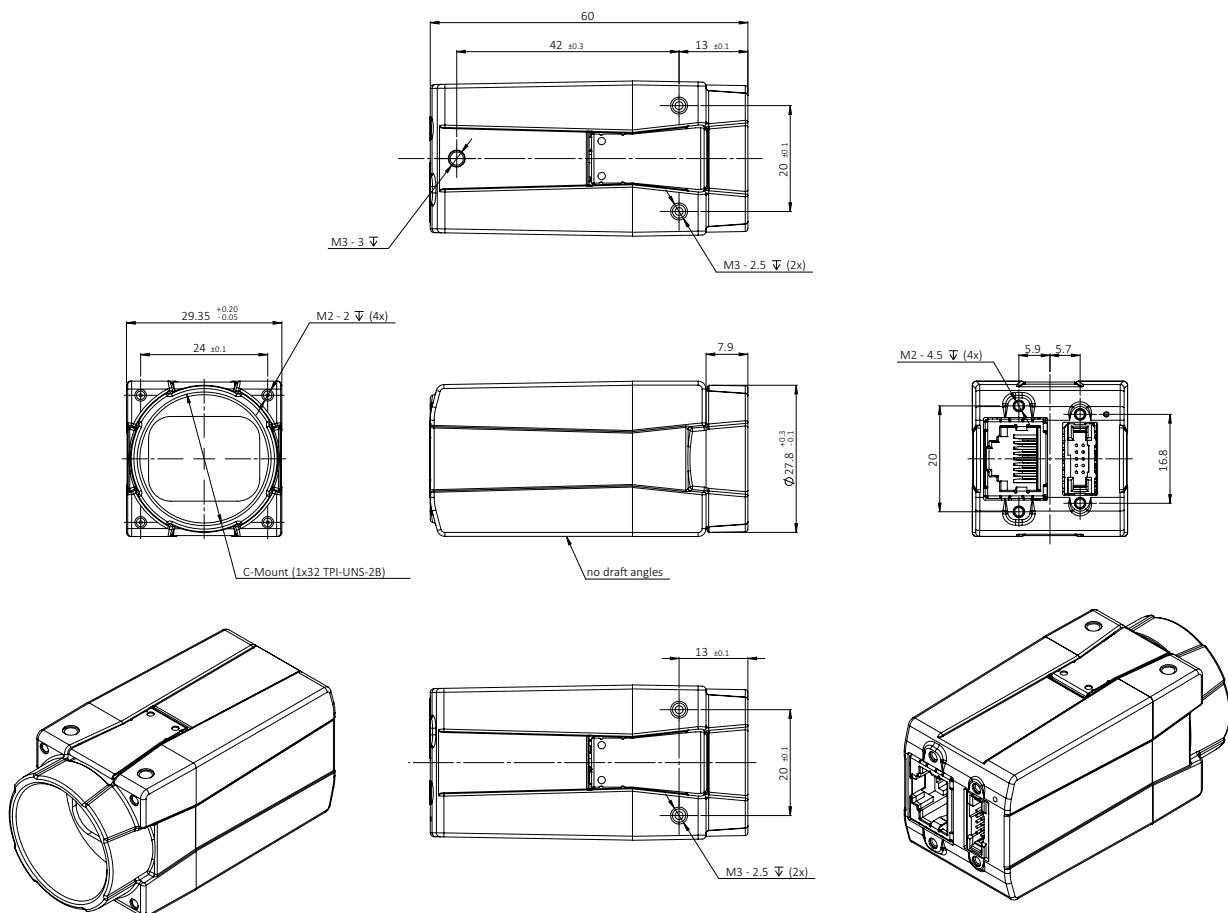

Figure 30: Dimensions for C-Mount models

CS-Mount

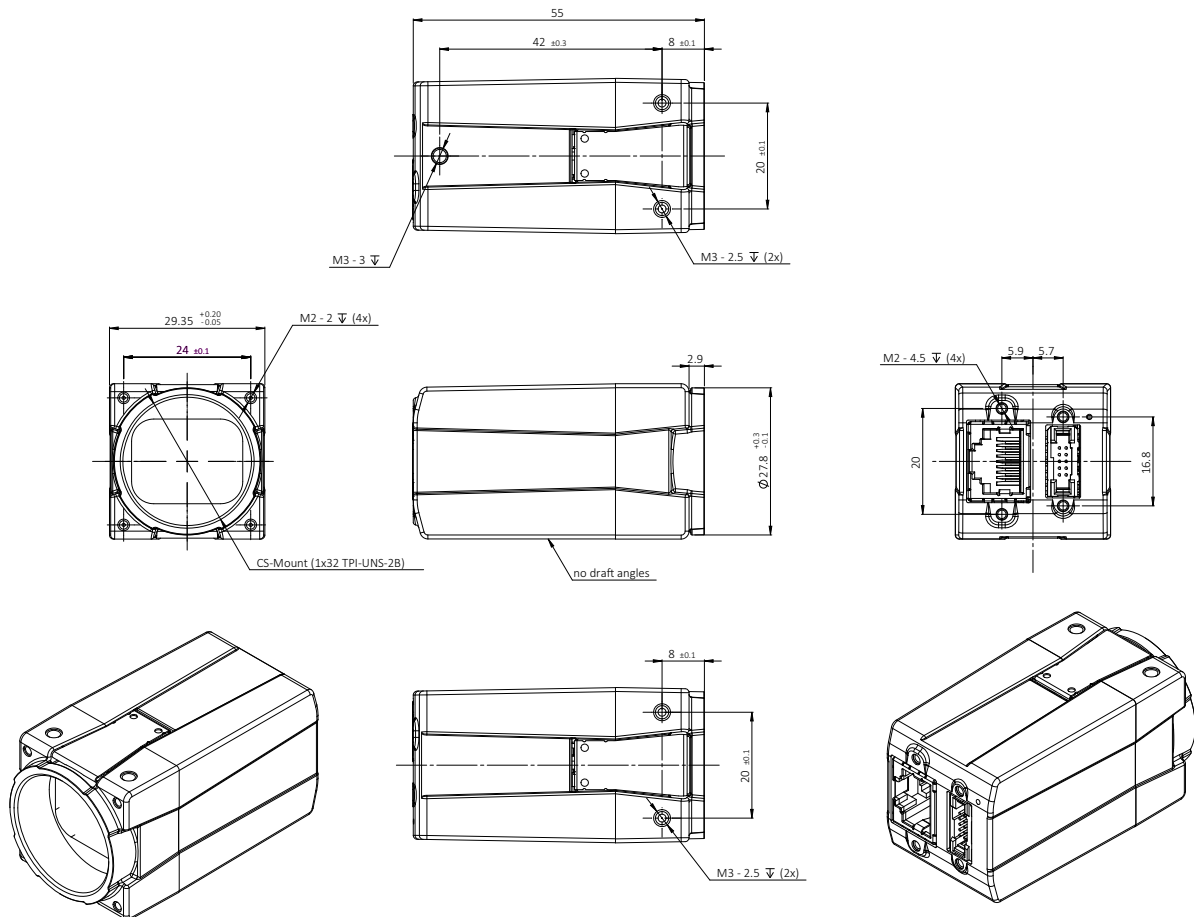

Figure 31: Dimensions for CS-Mount models

S-Mount

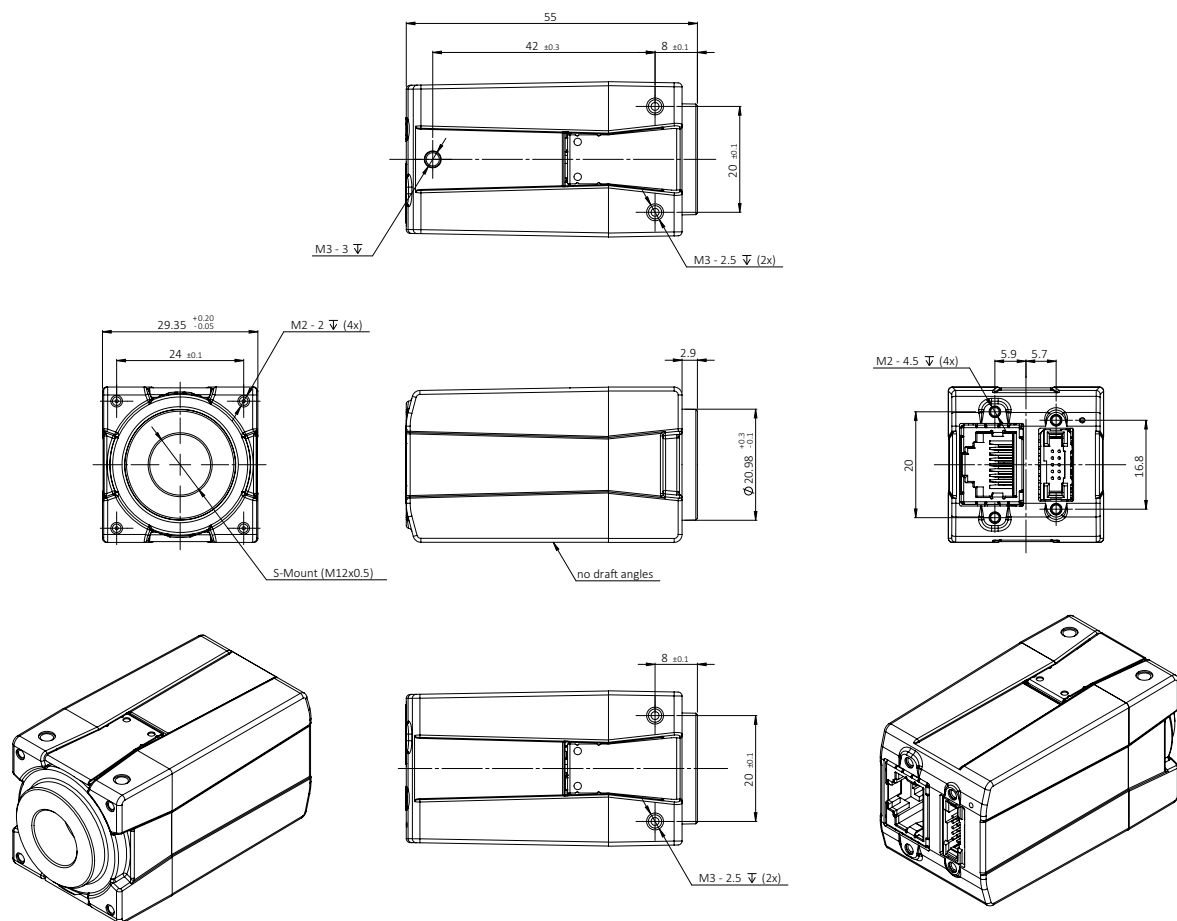

Figure 32: Dimensions for S-Mount models

Lens mounts and maximum protrusion



No need to readjust lens mounts

Alvium G5/G5X camera mounts are adjusted with high precision during manufacturing. Construction ensures permanent accuracy without need to readjust.

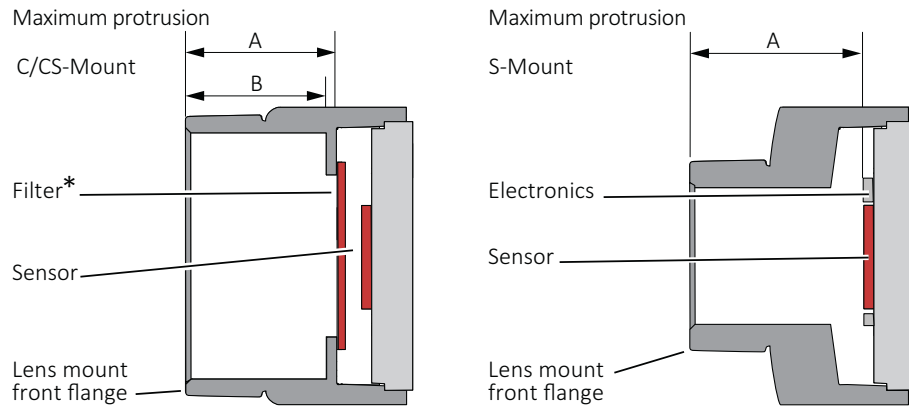

*Only color models are equipped with an IR cut filter

Figure 33: Maximum protrusion C-Mount, CS-Mount (left), and S-Mount (right)

Figure 33 shows schematics for maximum protrusion of lenses, Table 63 shows values for maximum protrusion.



NOTICE

Damage to sensor or optics by unsuitable lenses

The sensor, filter, or lens can be damaged if a lens exceeding maximum protrusion is mounted to the camera.

- Use lenses with less than the allowed maximum protrusion, see Table 63.
- See [Mounting the lens](#) on page 148.
- For S-Mount lenses, see [Mounting and focusing S-Mount lenses](#) on page 149.

Mount	Maximum protrusion
C-Mount	13.6 mm
CS-Mount	8.6 mm
S-Mount	11.0 mm

Table 63: Maximum protrusion for Alvium G5/G5X cameras

IR cut filter

The following table shows which Alvium G5/G5X models are equipped with an IR cut filter. The filter is permanently installed and cannot be removed.

Color or monochrome model	S-Mount	CS-Mount	C-Mount
Color	No filter	Type Hoya C5000 IR cut filter	
Monochrome	No filter		

Table 64: Optical filters availability

Cameras **without** IR cut filter have a higher sensitivity for low-light imaging. Moreover, spectral sensitivity is increased.

Cameras **with** IR cut filter are more accurate in reproduction of color, contrast, and sharpness, as the filter absorbs near-IR wavelengths. See [Figure 34](#) for filter transmission.



Spectral transmission values

The following curve shows typical transmission for type Hoya C5000 IR cut filter. Values may vary slightly by filter lot.

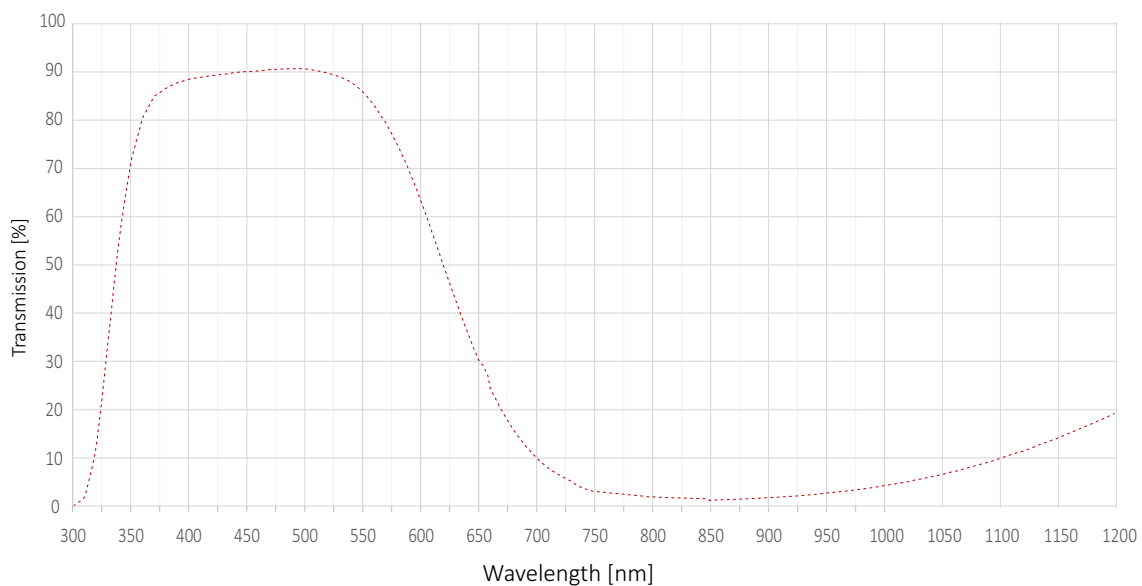

Figure 34: Spectral transmission for type Hoya C5000 IR cut filter (exemplary curve)



S-Mount lenses with IR cut design

For improved image quality, we recommend using S-Mount lenses that are IR- optimized or that have IR cut coating. See the S-Mount Lenses User Guide at www.alliedvision.com/fileadmin/content/documents/products/accessories/lenses/Allied_Vision/User_Guide/S-Mount-Lenses_User-Guide.pdf.

Sensor position accuracy

Sensor shift and rotation

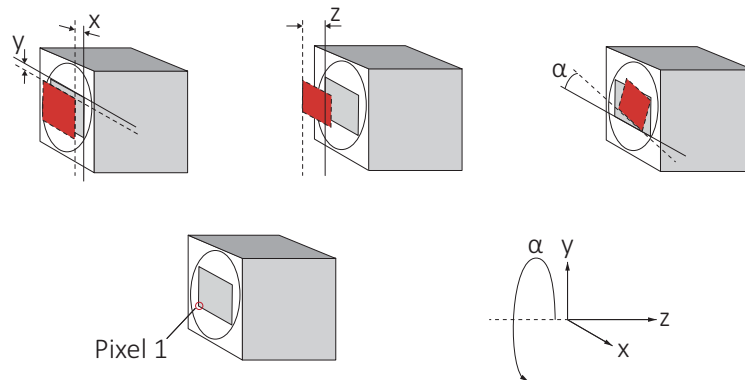

Gray rectangle: Reference sensor position **Red rectangle:** Current position
Straight line: Reference edge **Dotted line:** Current reference edge

The orientation of the z-axis deviates from scientific conventions to define tolerances of the flange focal distance.

Figure 35: Sensor shift and rotation

The following table defines the manufacturing accuracy for sensor positioning.

Criteria	Subject	Properties
Alignment method		Optical alignment of the photosensitive sensor area into the camera front module (lens mount front flange)
Reference Points	Sensor	Center of the pixel area (photo sensitive cells)
	Camera	Center of the lens mount
Accuracy	x/y-axis ¹	±150 µm (sensor shift)
	z	0 to -100 µm (optical back focal length)
	α ¹	±0.5 deg (sensor rotation as the deviation from the parallel to the camera bottom)

¹ We cannot measure or guarantee these values for S-Mount hardware options that are manufactured on customer request for: Alvium G5-052, -203, -291, -320 VSWIR, -507 Pol, -508, -508 Pol, -511, -530 VSWIR, -811, -812 UV, -1242, -1620, -2040, G5/G5X-2050, G5/G5X-2460.

Table 65: Alvium G5/G5X cameras, criteria of sensor position accuracy

Sensor tilt

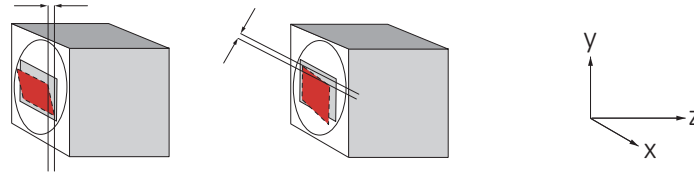

Gray rectangle: Reference sensor position **Red rectangle:** Current position

Figure 36: Sensor tilt

The following table defines sensor tilt as the variance between highest and lowest pixel of a sensor along the z-axis, measured in micrometers.

Alvium G5/G5X model	Pixel size	Maximum tilt
Alvium G5-052m/c	9.0 μm \times 9.0 μm	36 μm
Alvium G5-130 VSWIR	5 μm \times 5 μm	50 μm
Alvium G5-203m/c	4.5 μm \times 4.5 μm	41 μm
Alvium G5-240m/c	3.45 μm \times 3.45 μm	24 μm
Alvium G5-291m/c	4.5 μm \times 4.5 μm	18 μm
Alvium G5-320 VSWIR	3.45 μm \times 3.45 μm	24 μm
Alvium G5-500m/c	2.2 μm \times 2.2 μm	15 μm
Alvium G5-507m/c Pol	3.45 μm \times 3.45 μm	24 μm
Alvium G5-508m/c	3.45 μm \times 3.45 μm	24 μm
Alvium G5-508m/c Pol	3.45 μm \times 3.45 μm	24 μm
Alvium G5-510m/c	2.74 μm \times 2.74 μm	18 μm
Alvium G5-511m/c	2.74 μm \times 2.74 μm	18 μm
Alvium G5-530 VSWIR	3.45 μm \times 3.45 μm	24 μm
Alvium G5-811m/c	2.74 μm \times 2.74 μm	18 μm
Alvium G5-812 UV	2.74 μm \times 2.74 μm	15 μm
Alvium G5-1240m/c	1.85 μm \times 1.85 μm	12 μm
Alvium G5-1242m/c	2.74 μm \times 2.74 μm	18 μm
Alvium G5-1620m/c	2.74 μm \times 2.74 μm	18 μm
Alvium G5-2040m/c	2.74 μm \times 2.74 μm	18 μm
Alvium G5/G5X-2050m/c	2.4 μm \times 2.4 μm	12 μm
Alvium G5/G5X-2460m/c	2.74 μm \times 2.74 μm	18 μm

Table 66: Sensor tilt

User sets

Supported features

UserSet features enable to store individual settings on Alvium G5/G5X cameras. These user sets can be loaded by default, without needing to set values by software after every restart of the camera. Or they can be used to switch between different settings, for example, to adjust from daylight to artificial light.

User sets on Alvium G5/G5X cameras support all features except for:

- Selectors
- Command features
- Read-only features
- Features in the LUTControl1 category.

Trigger features and UserSetDefault

Trigger features are reset to default values when the default user set is loaded.

- Column **UserSetLoad** displays how user values are affected when the command for **UserSetLoad** is executed.
- Column **DeviceReset** displays how user values are affected when the command for **DeviceReset** is executed.

Feature	Default value	UserSetDefault	DeviceReset
TriggerActivation	<i>RisingEdge</i>	Default value	Default value
TriggerMode	<i>Off</i>	Default value	Default value
TriggerSelector	<i>AcquisitionStart</i>	User value	Default value
TriggerSoftware	[Command]	Not applicable	Not applicable
TriggerSource	<i>Software</i>	Default value	Default value

Table 67: Trigger features being reset

Camera feature availability

Alvium G5/G5X cameras support a number of standard and extended features. The following tables compare the availability of selected features by model.



Feature descriptions and firmware downloads

Alvium Features Reference: www.alliedvision.com/en/support/technical-documentation/alvium-gige-documentation

Firmware downloads: www.alliedvision.com/en/support/firmware-downloads.

Image control	Monochrome models	Color models	Supported models
Adaptive noise correction	✓	✓	All, except for: G5-507 Pol, -508 Pol
Auto exposure	✓	✓	All
Auto gain	✓	✓	All
Auto white balance	-	✓	All, except for: G5-507 Pol, -508 Pol
Color transformation (including hue, saturation)	-	✓	
Contrast	✓	✓	
Custom convolution	✓	✓	
De-Bayering up to 5x5	-	✓	
Digital binning	✓	✓	
DPC (defect pixel correction)	✓	✓	
FPNC (fixed pattern noise correction)	✓	✓	G5-240, -500, -508, -510, -511, -811, -812 UV, -1240, -1242, -1620, -2040, G5/G5X-2460
Gamma	✓	✓	All
Lens shading correction	✓	✓	All
Look up table (LUT)	✓	✓	All, except for: G5-507 Pol, -508 Pol
Multiple ROI (regions of interest)	✓	✓	All, except for: G5-500, -1240, G5/G5X-2050
Reverse X/Y	✓	✓	All

Table 68: Image control features by Alvium G5/G5X model (sheet 1 of 2)

Image control	Monochrome models	Color models	Supported models
Sensor binning	✓	-	G5-203m, -240m, -291m, -500m, -508m, -510m, -511m, -811m, -812 UV, -1242m, -1620m, -2040m, G5/G5X-2460m
Sharpness/Blur	✓	✓	All, except for: G5-507 Pol, -508 Pol
Single ROI (region of interest)	✓	✓	All

Table 68: Image control features by Alvium G5/G5X model (sheet 2 of 2)

Camera control	Monochrome models	Color models	Supported models
Acquisition frame rate	✓	✓	All
Action commands	✓	✓	All
Bandwidth control (DeviceLinkThroughputLimit)	✓	✓	All
Burst mode (TransferControl features)	✓	✓	All
Counters and timers	✓	✓	All
Events	✓	✓	All
Firmware update in the field	✓	✓	All
Image chunk data	✓	✓	All
I/O and trigger control	✓	✓	All
Readout modes (SensorBitDepth)	✓	✓	G5-052, -130 VSWIR, -240, -291, -320 VSWIR, -508, -508 Pol, -530 VSWIR
Sequencer	✓	✓	All, except for: G5-500, -1240, G5X-2050
Serial I/Os	✓	✓	All
Temperature monitoring (mainboard, companion board, interface board)	✓	✓	All
User sets	✓	✓	All

Table 69: Camera control features by Alvium G5/G5X model

Lenses: Focal length vs. field of view

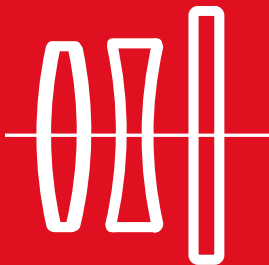

This chapter includes:

About this chapter	134
Optical vignetting with certain lenses	134
About S-Mount lenses	135
Focal length versus field of view	135

About this chapter

This section presents tables that list selected fields of view (FOV) depending on sensor size, distance, and focal length of the lens.

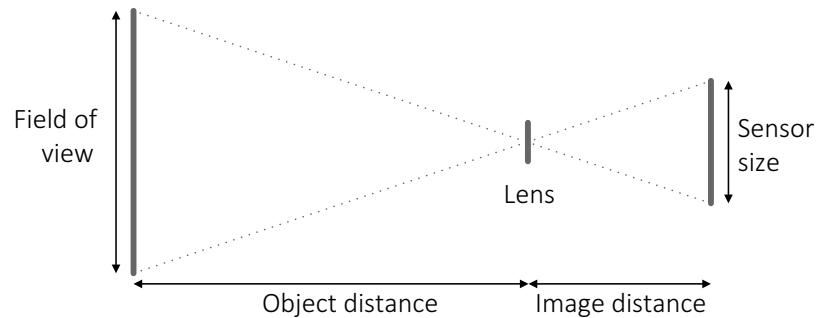

Figure 37: Parameters used in tables for focal length versus FOV



Allied Vision S-Mount lenses

For technical data of Allied Vision S-Mount lenses with dedicated operating instructions, see the S-Mount Lenses User Guide at

www.alliedvision.com/fileadmin/content/documents/products/accessories/lenses/Allied_Vision/User_Guide/S-Mount-Lenses_User-Guide.pdf.

Parameters in tables

The distance to the object is measured from the first principal the plane of the lens to the object. For some lenses, manufacturers do not define the principal plane position. Production spread causes tolerances for all values, including actual focal lengths. Calculations apply for image reproduction without distortion. Therefore, values do not apply for fisheye lenses.

Please ask your Allied Vision Sales representative in case you need more information.

Optical vignetting with certain lenses

Lenses with short focal lengths may show optical vignetting at the edges of the image. Microlenses on the sensor pixels can increase the effect.

For demanding applications, we suggest testing camera and lens to find a suitable setup. If you have questions, please contact your Allied Vision Sales representative.

About S-Mount lenses

Alvium G5/G5X S-Mount models have no filter. We recommend using S-Mount lenses with an integrated IR-cut filter for a better image quality.

Read [Mounting and focusing S-Mount lenses](#) on page 149 to avoid damage when using S-Mount lenses.

Focal length versus field of view

Alvium G5-052m/c

Values for G5-052m/c cameras with Type 1/1.7 (9.2 mm diagonal) sensors:

Focal length [mm]	Field of view (H × V [mm])	
	Object distance = 500 mm	Object distance = 1000 mm
5	671 × 560	1348 × 1125
6	558 × 466	1122 × 937
8	417 × 348	840 × 701
12	275 × 230	558 × 466
16	205 × 171	417 × 348
25	129 × 107	264 × 221
35	90 × 75	187 × 156
50	61 × 51	129 × 107

Table 70: Focal length versus field of view for Alvium G5-052m/c

Alvium G5-130m VSWIR

Values for G5-130m VSWIR cameras with Type 1/2 (8.2 mm diagonal) sensors:

Focal length [mm]	Field of view (H × V [mm])	
	Object distance = 500 mm	Object distance = 1000 mm
5	671 × 560	1348 × 1125
6	558 × 466	1122 × 937
8	417 × 348	840 × 701
12	275 × 230	558 × 466
16	205 × 171	417 × 348
25	129 × 107	264 × 221
35	90 × 75	187 × 156
50	61 × 51	129 × 107

Table 71: Focal length versus field of view for Alvium G5-130m VSWIR

Alvium G5-203m/c

Values for G5-203m/c cameras with Type 1/1.7 (9.2 mm diagonal) sensors:

Focal length [mm]	Field of view (H × V [mm])	
	Object distance = 500 mm	Object distance = 1000 mm
5	727 × 556	1461 × 1118
6	605 × 462	1217 × 930
8	452 × 345	911 × 696
12	299 × 228	605 × 462
16	222 × 170	452 × 345
25	140 × 107	286 × 219
35	98 × 75	202 × 155
50	66 × 51	140 × 107

Table 72: Focal length versus field of view for Alvium G5-203m/c

Alvium G5-240m/c

Values for G5-240m/c cameras with Type 1/2.3 (7.9 mm diagonal) sensors:

Focal length [mm]	Field of view (H × V in [mm])	
	Object distance = 500 mm	Object distance = 1000 mm
4.8	691 × 433	1389 × 871
6	552 × 346	1110 × 696
8	412 × 258	831 × 521
12	272 × 171	552 × 346
16	203 × 127	412 × 258
25	127 × 80	261 × 164
35	89 × 56	185 × 116
50	60 × 38	127 × 80

Table 73: Focal length versus field of view for Alvium G5-240m/c

Alvium G5-291m/c

Values for G5-291m/c cameras with Type 2/3 (10.8 mm diagonal) sensors:

Focal length [mm]	Field of view (H × V in [mm])	
	Object distance = 500 mm	Object distance = 1000 mm
6	644 × 642	1296 × 1293
8	481 × 480	970 × 968
12	318 × 317	644 × 642
16	237 × 236	481 × 480
25	149 × 148	305 × 304
35	104 × 104	216 × 215
50	70 × 70	149 × 148

Table 74: Focal length versus field of view for Alvium G5-291m/c

Alvium G5-320 VSWIR

Values for G5-320 VSWIR cameras with Type 1/1.8 (8.9 mm diagonal) sensors:

Focal length [mm]	Field of view (H × V in [mm])	
	Object distance = 500 mm	Object distance = 1000 mm
6	591 × 439	1189 × 882
8	441 × 328	890 × 661
12	292 × 217	591 × 439
16	217 × 161	441 × 328
25	136 × 101	280 × 208
35	95 × 71	198 × 147
50	65 × 48	136 × 101
75	41 × 30	89 × 66

Table 75: Focal length versus field of view for Alvium G5-320 VSWIR

Alvium G5-500m/c

Values for G5-500m/c cameras with Type 1/2.5 (7.1 mm diagonal) sensors:

Focal length [mm]	Field of view (H × V in [mm])	
	Object distance = 500 mm	Object distance = 1000 mm
2.8	1013 × 759	2031 × 1523
3.6	786 × 590	1578 × 1184
4.8	588 × 441	1182 × 887
6	469 × 352	945 × 709
8	351 × 263	707 × 530
12	232 × 174	469 × 352
16	172 × 129	351 × 263
25	108 × 81	222 × 167

Table 76: Alvium G5-500m/c focal length versus field of view

Alvium G5-507m/c Pol, -508m/c, -508m/c Pol

Values for G5-507m/c Pol, -508m/c, and -508m/c Pol cameras with Type 2/3 (11.1 mm diagonal) sensors:

Focal length [mm]	Field of view (H × V in [mm])	
	Object distance = 500 mm	Object distance = 1000 mm
6	700 × 584	1408 × 1175
8	523 × 436	1054 × 880
12	346 × 288	700 × 584
16	257 × 215	523 × 436
25	162 × 135	332 × 277
35	113 × 94	234 × 196
50	77 × 64	162 × 135

Table 77: Focal length versus field of view for Alvium G5-507m/c Pol, -508m/c, -508m/c Pol

Alvium G5-510m/c, -511m/c

Values for G5-510m/c and -511m/c cameras with Type 1/1.8 (8.8 mm diagonal) sensors:

Focal length [mm]	Field of view (H × V in [mm])	
	Object distance = 500 mm	Object distance = 1000 mm
5	671 × 560	1348 × 1125
6	558 × 466	1122 × 937
8	417 × 348	840 × 701
12	275 × 230	558 × 466
16	205 × 171	417 × 348
25	129 × 107	264 × 221
35	90 × 75	187 × 156
50	61 × 51	129 × 107

Table 78: Focal length versus field of view for Alvium G5-510m/c and -511m/c

Alvium G5-530 VSWIR

Values for G5-530 VSWIR cameras with Type 1/1.4 (11.4 mm diagonal) sensors:

Focal length [mm]	Field of view (H × V in [mm])	
	Object distance = 500 mm	Object distance = 1000 mm
6	736 × 584	1481 × 1175
8	550 × 436	1109 × 880
12	364 × 288	736 × 584
16	271 × 215	550 × 436
25	170 × 135	349 × 277
35	119 × 94	247 × 196
50	80 × 64	170 × 135
75	51 × 40	110 × 87

Table 79: Focal length versus field of view for Alvium G5-530 VSWIR

Alvium G5-811m/c, -812 UV

Values for G5-811m/c and -812 UV cameras with Type 2/3 (11.0 mm diagonal) sensors:

Focal length [mm]	Field of view (H × V in [mm])	
	Object distance = 500 mm	Object distance = 1000 mm
5	773 × 773	1553 × 1553
6	642 × 642	1293 × 1293
8	480 × 480	968 × 968
12	317 × 317	642 × 642
16	236 × 236	480 × 480
25	148 × 148	304 × 304
35	104 × 104	215 × 215
50	70 × 70	148 × 148

Table 80: Focal length versus field of view for Alvium G5-811m/c, -812 UV

Alvium G5-1240m/c

Values for G5-1240m/c cameras with Type 1/1.7 (9.3 mm diagonal) sensors:

Focal length [mm]	Field of view (H × V in [mm])	
	Object distance = 500 mm	Object distance = 1000 mm
4.8	763 × 578	1534 × 1161
6	609 × 461	1226 × 928
8	455 × 344	918 × 694
12	301 × 228	609 × 461
16	224 × 169	455 × 344
25	141 × 106	289 × 218
35	98 × 74	204 × 154
50	67 × 50	141 × 106

Table 81: Alvium G5-1240m/c focal length versus field of view

Alvium G5-1242m/c

Values for G5-1242m/c cameras with Type 1/1.1 (14.0 mm diagonal) sensors:

Focal length [mm]	Field of view (H × V in [mm])	
	Object distance = 500 mm	Object distance = 1000 mm
6	931 × 679	1874 × 1365
8	696 × 507	1403 × 1022
12	460 × 335	931 × 679
16	342 × 249	696 × 507
25	215 × 157	441 × 321
35	150 × 109	312 × 227
50	102 × 74	215 × 157
75	64 × 47	139 × 102

Table 82: Focal length versus field of view for Alvium G5-1242m/c

Alvium G5-1620m/c

Values for G5-1620m/c cameras with Type 1.1 (16.8mm diagonal) sensors:

Focal length [mm]	Field of view (H × V in [mm])	
	Object distance = 500 mm	Object distance = 1000 mm
5	1445 × 825	2905 × 1658
6	1202 × 686	2419 × 1380
8	898 × 512	1810 × 1033
12	594 × 339	1202 × 686
16	442 × 252	898 × 512
25	277 × 158	569 × 325
35	194 × 111	403 × 230
50	131 × 75	277 × 158
75	83 × 47	180 × 103

Table 83: Focal length versus field of view for Alvium G5-1620m/c

Alvium G5-2040m/c

Values for G5-2040m/c cameras with Type 1.1 (17.5 mm diagonal) sensors:

Focal length [mm]	Field of view (H × V in [mm])	
	Object distance = 500 mm	Object distance = 1000 mm
6	1018 × 1018	2048 × 2048
8	760 × 760	1533 × 1533
12	503 × 503	1018 × 1018
16	374 × 374	760 × 760
25	235 × 235	482 × 482
35	164 × 164	341 × 341
50	111 × 111	235 × 235
75	70 × 70	152 × 152
85	60 × 60	133 × 133

Table 84: Focal length versus field of view for Alvium G5-2040m/c

Alvium G5/G5X-2050m/c

Values for G5/G5X-2050m/c cameras with Type 1/2 (8.2 mm diagonal) sensors:

Focal length [mm]	Field of view (H × V in [mm])	
	Object distance = 500 mm	Object distance = 1000 mm
8	811 × 542	1636 × 1093
12	536 × 358	1086 × 726
16	399 × 267	811 × 542
25	251 × 167	514 × 344
35	175 × 117	364 × 243
50	119 × 79	251 × 167
75	75 × 50	163 × 109
85	64 × 43	142 × 95
100	53 × 35	119 × 79

Table 85: Alvium G5/G5X-2050m/c focal length versus field of view

Alvium G5/G5X-2460m/c

Values for G5/G5X-2460m/c cameras with Type 1.2 (19.3 mm diagonal) sensors:

Focal length [mm]	Field of view (H × V in [mm])	
	Object distance = 500 mm	Object distance = 1000 mm
8	898 × 776	1810 × 1566
12	594 × 513	1202 × 1040
16	442 × 382	898 × 776
25	277 × 240	569 × 492
35	194 × 168	403 × 348
50	131 × 114	277 × 240
75	83 × 72	180 × 156

Table 86: Focal length versus field of view for Alvium G5/G5X-2460m/c

Installing the camera



This chapter includes:

Touching hot cameras	145
Mounting the heat sink.....	145
Mounting the camera	146
Mounting the lens.....	148
Configuring the host computer	152
Connecting to the host computer	155
Powering up the camera.....	156
Software for your Alvium G5	157

Touching hot cameras



CAUTION

Risk of burns

A camera in operation can reach temperature levels which could cause burns.

- Wear protective gloves when you touch a camera that is heated up.
- Ensure proper cooling of the camera.

Mounting the heat sink



Automatic power off

If the mainboard temperature exceeds the specified maximum for more than two seconds, the camera is powered off automatically. Afterwards, you must power cycle the camera for restart. The current value for mainboard temperature is output by `DeviceTemperature`.

Keep the operating temperature in the specified range to enable best image quality and to protect the camera from damage. In many cases, mounting the camera on a metal surface or using a lens will be sufficient to cool the camera effectively. However, especially when operated in higher ambient temperatures, additional measures for heat dissipation, such as using a heat sink, should be considered.



Heat dissipation

For a suitable heat sink, see www.alliedvision.com/en/support/accessory-documentation.

For more information on heat dissipation, see the Optimum Heat Dissipation for Alvium G5/G5X Cameras application note: www.alliedvision.com/en/support/technical-documentation/alvium-gige-documentation.



NOTICE

Damage to the camera by heat sinks mounted improperly

Adhere to the instructions and safety notes provided by the manufacturer of the heat sink.



NOTICE

Damage to the sensor, filter, and lens by corrosive substances

Some conductive media for heat sinks contain corrosive substances that can damage optical surfaces of the sensor, filter, and lens.

- Cover the optical path of the camera when you apply heat sink compound or adhesive to prevent substances and fumes from damaging optical surfaces.
- Adhere to the instructions and safety notes provided by the manufacturer of the conductive media.

Mounting the camera



CAUTION

Injury by falling cameras or lenses

A falling camera or lens can cause injury.

- Ensure proper mounting of cameras and lenses, especially for dynamic applications.
- Mount cameras as described in the instructions.
- Use all 3 bottom mounting threads for applications with high acceleration.
- Always make sure the mounting threads are intact.
- Fasten screws with maximum torque, using the entire thread engagement. For less thread engagement, see [Adapting maximum torque values](#) on page 147.
- We recommend you to apply thread locking.
- Use a lens support for heavy lenses.

Bottom or top mounting

Especially for dynamic applications with high acceleration, mount the camera using the bottom mounting threads in addition.

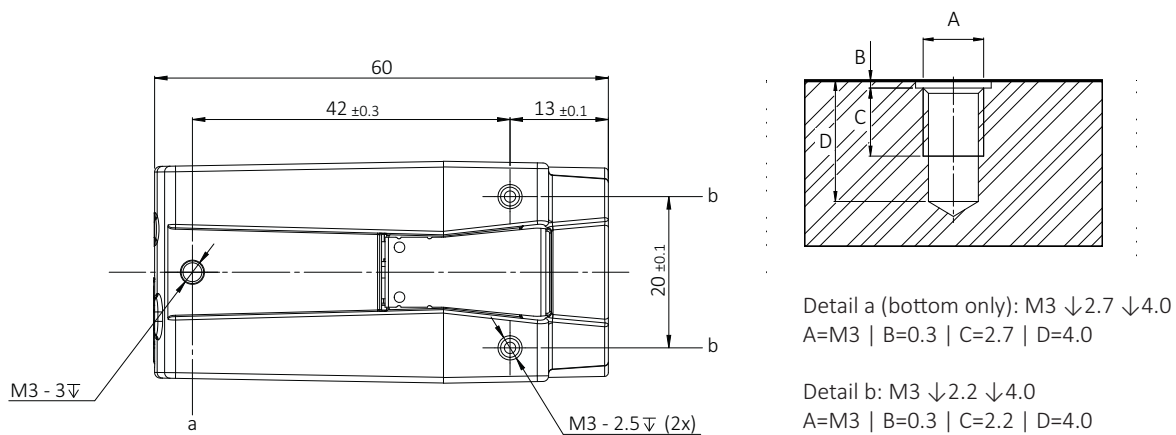

Figure 38: Mounting threads bottom (a and b) and top (b)

The maximum torque value applies only if the entire thread engagement is used. For other values, see [Adapting maximum torque values](#) on page 147. For technical drawings, see [Dimensions and mass](#) on page 123.

1. As shown in [Figure 38](#), mount the camera to the base using suitable M3 screws
 - a. Mounting thread a (bottom only): At 0.62 Nm maximum torque for a thread engagement (C) of 2.7 mm between screws and mounting threads.
 - b. Mounting thread b: At 0.51 Nm maximum torque for a thread engagement (C) of 2.2 mm between screws and mounting threads.
2. Continue with [Mounting the lens](#) on page 148.

Front mounting

Especially for dynamic applications with high acceleration, mount the camera using the bottom mounting threads in addition.

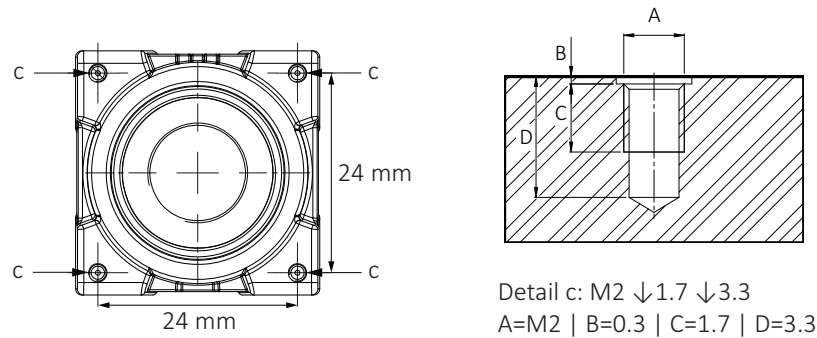

Figure 39: Camera front with mounting threads (c)

The maximum torque value applies only if the entire thread engagement is used. For other values, see [Adapting maximum torque values](#) on page 147.

1. Mount the camera to the base using suitable M2 screws at 0.17 Nm maximum torque for a thread engagement (C) of 1.7 mm between screws and mounting threads, see [Figure 39](#). For technical drawings, see [Dimensions and mass](#) on page 123.
We recommend you to additionally use bottom and top mounting threads for a more solid connection.
2. Continue with [Mounting the lens](#) on page 148.

Adapting maximum torque values

This is a general example. Use the corresponding values for your camera. The total screw length composes of the mounting holes length and the height of your mounting base. For using less than the recommended length of thread engagement, calculate maximum torque as follows

$$\frac{\text{Current length of thread engagement}}{\text{Length of thread engagement in table}} \times \text{Torque in table} = \text{Current torque}$$

Example for a length of thread engagement of **1.4 mm** instead of 1.7 mm:
1.4 mm / 1.7 mm × 0.17 Nm = 0.14 Nm

Thread group	Thread position	Thread type	Total protrusion	Length of thread engagement	Maximum torque
c	Front mounting	M2	2 mm	1.7 mm	0.17 Nm
c	Front mounting	M2	2 mm	1.4 mm	0.14 Nm

Table 87: Adjusting maximum torque values

To ensure that the screws do not become loose over time, we recommend you to use means for securing screws, such as screw locking varnish.

**Tripod adapter**

For the Alvium G1 tripod adapter, see www.alliedvision.com/en/support/accessory-documentation.

Mounting the lens

Observe the following notes before you mount lenses to Alvium G5/G5X cameras.

**CAUTION****Injury by falling cameras or lenses**

A falling camera or lens can cause injury.

- Ensure proper mounting of cameras and lenses, especially for dynamic applications.
- Mount cameras as described in the instructions.
- Use a lens support for heavy lenses.

**CAUTION****Risk of cuts by sharp edges of lens mounts**

The threads of the lens mount can have sharp edges.

Be careful when mounting or unmounting lenses.

**NOTICE****Damage to sensor or optics by unsuitable lenses**

The sensor, filter, or lens can be damaged if a lens exceeding maximum protrusion is mounted to the camera.

- Use lenses only up to the specified maximum protrusion.
- S-Mount lenses must be screwed into the camera less than maximum protrusion (11.0 mm).
- Avoid short S-Mount lenses falling into the camera.

Mounting and focusing S-Mount lenses



Allied Vision S-Mount lenses

For technical data of Allied Vision S-Mount lenses with dedicated operating instructions, see the S-Mount Lenses User Guide at www.alliedvision.com/fileadmin/content/documents/products/accessories/lenses/Allied_Vision/User_Guide/S-Mount-Lenses_User-Guide.pdf.

This section instructs how to use S-Mount lenses with your camera safely. S-Mount lenses are screwed into the mount to adjust focus. Vibration moves lenses out of position. Several techniques can be used to fasten S-Mount lenses in focus. We recommend using fixing nuts. See instructions in this section.



Drawings of cameras and fixing nuts

Drawings in the instructions are schematic.

Several manufacturers offer various types of S-Mount fixing nuts. The type shown in the instructions drawings is an example.

We recommend using pinch nose pliers to tighten fixing nuts.

Figure 40 shows how fixing nuts lock S-Mount lenses.
Follow the instructions to lock the lens in focus position.

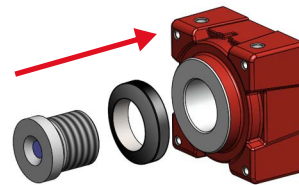

Figure 40: Fixing nut locking an S-Mount lens

NOTICE
Damage to sensor or optics by improper handling

If an S-Mount lens is screwed against the sensor, sensor and lens can be damaged.

- Screw in the lens at 11.0 mm maximum protrusion.
- Follow the instructions carefully.

Determining the allowed range for the position of the lens

1. Measure the length of the lens.
2. Calculate: $a = c - b$
 a: length of the mounted lens, measured from lens mount front flange
 b: maximum protrusion (11.0 mm)
 c: length of the lens

See [Lens mounts and maximum protrusion](#) on page 126.

3. Set a gauge to the length of (a).

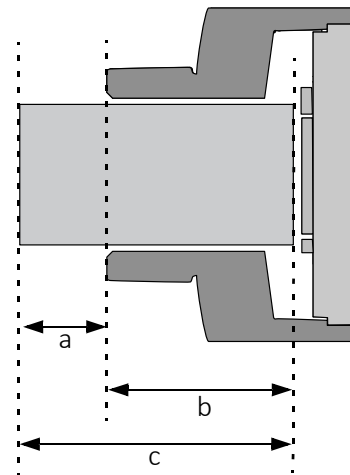

Figure 41: S-Mount lens and maximum protrusion

Mounting the fixing nut to the lens

4. Screw the fixing nut clockwise onto the lens until you can hold the front part (d) of the lens with your finger tips.



Figure 42: Lens and fixing nut

Focusing the lens

5. **Checking (a) with a gauge**, slowly screw the lens clockwise into the lens mount until the image is roughly in focus.
6. Slowly screw the lens in and out until you have found most accurate focus.

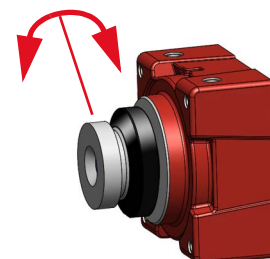

Figure 43: Adjusting focus

NOTICE
Damage to lens threads and fixing nut by excessive force

If the fixing nut is screwed with too much force, threads are worn out and the lens cannot be locked anymore.

Screw fixing nuts hand tight to keep the lens in a fixed position.

Locking focus

Pinch nose pliers are used to screw the fixing nut:

7. Holding the lens in position with one hand, screw the fixing nut clockwise against the lens mount until you feel the lens is locked.

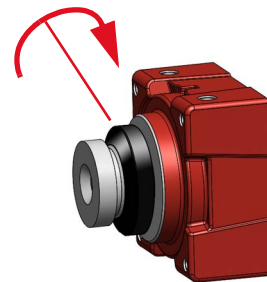

Figure 44: Tightening the fixing nut

Checking focus is set and locked properly

8. Check No.1: Try to rotate the lens with little strength in both directions to ensure the lens is safely locked in position.

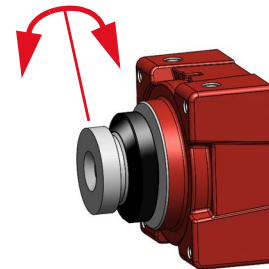

Figure 45: Checking lens is safely locked

9. Check No. 2: S-Mount thread allows a slightly tilted lens position. In this case, focus for a common object plane varies over the image plane.

If focus is constant over the image plane, you are done.

If focus varies over the image plane, the lens is tilted. Continue with [10](#).

10. Loosen the fixing nut.

11. Continue with [6](#).

The lens is locked in focus and ready for operation.

Configuring the host computer



Please consider

Alvium G5/G5X cameras require different hardware and settings than 1000BASE-T cameras like Mako or Prosilica GT cameras. We suggest you:

- Build up general knowledge: on page 180.
- Find solutions for issues: [Troubleshooting common issues](#) on page 197.

Alvium G5/G5X cameras can operate on 5GBASE-T and 1000BASE-T NICs.

Requirements to reach the maximum camera frame rate:

- 5GBASE-T speed PCI Express NIC **on Desktop PCs**
- USB adapters **on laptops**: As of writing this document, USB adapters in general are not recommended due to performance limits.
- Jumbo Packet support for minimum 9,000 to 16,000 bytes. See [Enabling Jumbo Packets](#) on page 154.

Recommendations

- Use only one camera per network port. For than one camera, use additional NICs or NICs with more than one port.
- Disable all unused NIC services and protocols (for example, activate only filter drivers for IPv4 and GigE).
- You can select between Fixed Link Speed and Auto Negotiation for the NIC driver's link speed settings.
 - **Fixed Link Speed**: If you set a link speed not supported by the camera, the link is not negotiated. Alvium G5/G5X cameras support 5 Gbit/s for full performance or 1 Gbit/s for host systems that do not support 5 Gbit/s.
 - **Auto Negotiation**: We recommend using Auto Negotiation. The maximum link speed supported by the host system and the camera is set automatically. Therefore, the common link speed for the camera and host system may be lower than the maximum supported link speed of one of the two.



NOTICE

Network security

If cameras are used on mixed-use networks (with printers, Internet, and email), the network security may be affected, the camera performance as well.

- Use cameras only in trusted networks as required by the GigE Vision protocol.
- Check with your network administrator if required for network configuration.

Installing the NIC driver

Install the NIC driver from your network card manufacturer if available. If no installation application is provided, update the driver manually.

Linux: Updating the driver manually

Follow the instructions by the NIC manufacturer.

Windows: Updating the driver manually

1. Open the **Device Manager** with administrator permission.
2. Under **Network Adapters**, locate the Ethernet network adapter, right-click the entry, and select **Update Driver Software** in the menu.
3. Select the **Search automatically for updated driver software** or **Browse my computer for driver software**.
4. Click **Close** after the driver has been installed.

IP settings

After the initial NIC hardware installation, connect the NIC directly to the camera. The default configuration assigns an IP address automatically using the LLA (Link-Local Address) range of 169.254.xxx.xxx or an address defined by the DHCP (Dynamic Host Configuration Protocol) server, if present. This setup is a typical solution for single-camera operation or multiple cameras connected to the same NIC.

If you are going to operate multiple cameras on different networks, you can use the following configuration as a template.

All network devices (such as NICs, hubs or GigE cameras) require unique IP addresses. But connected devices must share the same address space. In the example shown in [Table 88](#), 3 cameras are connected to a common host PC, using 2 separate NICs. The address space for NIC 1 is 192.168.**100**, for NIC 2 it is 192.168.**101**:

Device	IP address	Subnet mask	Default gateway
NIC 1	192.168.100.1	255.255.255.0	Blank
Camera 1 connected to NIC 1	192.168.100.2	255.255.255.0	Blank
NIC 2	192.168.101.1	255.255.255.0	Blank
Camera 2 connected to NIC 2	192.168.101.2	255.255.255.0	Blank
Camera 3 connected to NIC 2	192.168.101.3	255.255.255.0	Blank

Table 88: Static IP addresses for NICs and connected cameras



Applying advanced IP settings for cameras

See [Configuring IP settings](#) on page 155 for instructions.

Adjusting the NIC driver settings

The NIC should be adjusted to improve system performance when using Alvium G5/G5X cameras. This is achieved by minimizing the CPU usage in order to avoid dropped or resent packets.

Edit the NIC driver properties according to the values in the following table. The names and availability of the properties listed may vary depending on

- NIC manufacturer
- Operating system
- Camera model.

Property	Value
Packet Size, Frame Size, Jumbo Packet, or Maximum Transmission Unit	Maximum value configurable
Interrupt moderation	Enable
Interrupt moderation rate	Start with NIC's default value and experiment with different setting if required
Receive buffers	Maximum value configurable

Table 89: NIC settings

Default packet size

At startup, Alvium G5/G5X cameras have a default packet size of 576 bytes on the device stream channel. This enables optimum backward compatibility when ancient network hardware is used or when the network packets are tunneled through other protocols. Consider, that this packet size creates a large overhead on the host, which does not allow the full throughput most likely.

Enabling Jumbo Packets

We recommend you to increase the packet size to the maximum value supported by all parts of the system. The effective packet size should be at least around **9,000 bytes**. Configure the NIC settings as follows:

1. Open the **Device Manager** with administrator permission.
2. Under **Network Adapters**, locate the Ethernet network adapter, right-click the entry, and select **Properties** in the menu.
3. Adjust the corresponding settings to match the values required in [Table 89](#).



Easy adjustment of the packet size

We recommend using **Vimba X** to adjust the packet size on connected cameras or you can use the Vmb APIs of **Vimba X**.

Download: www.alliedvision.com/en/products/software/vimba-x-sdk

Connecting to the host computer

Use a Category 6 or higher rated Ethernet cable to connect the Alvium G5/G5X camera to the NIC. Crossover cabling is not required but does work. The camera has circuitry to determine if a crossover cable is being used.



We recommend Category 6 (CAT6) or higher rated Ethernet cables for Alvium G5/G5X cameras. A different rating may not sustain peak interface bandwidth; leading to lost connectivity or dropped frames coming from the camera.

After you have installed the **Vimba X**, including **Vimba X Viewer** or a third-party application to your host computer, connect your Alvium G5/G5X camera via an Ethernet cable. If your camera is not PoE powered, connect the TFM I/O cable to power the camera.

Configuring IP settings



Examples for IP settings

See [IP settings](#) on page 153 for details.

1. Open **Vimba X Viewer**.
2. Click **IP** (a) to open the **IP Widget**.
The window of the IP Widget opens.
3. Select the camera (b) to be configured.
4. In the IP Widget, select **Persistent IP** (c).
5. Enter IP address settings (d).
6. Click **Write** (e) to apply settings for the camera.

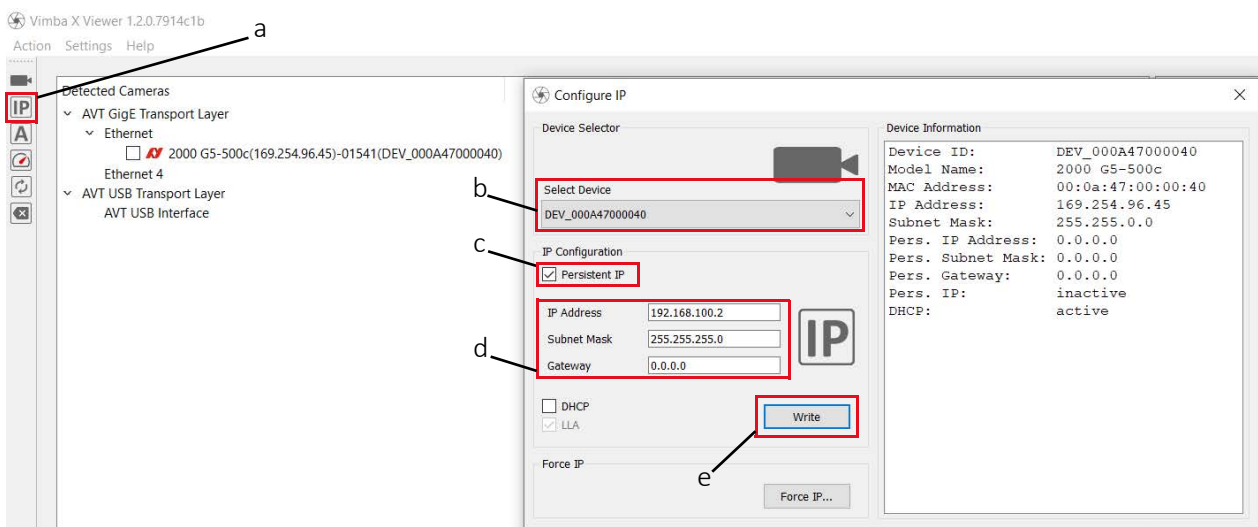

Figure 46: Configuring IP settings with the IP Widget of Vimba X Viewer

7. Restart the camera.



The camera is not recognized

Of course, the camera will not be recognized any more until you have changed system IP settings in step 9.

8. Continue for the other cameras from step 2. to 7.
9. Change system IP settings.

Powering up the camera

Powering the camera via I/O port

When cameras are powered by both the 10-pin TFM I/O port and by PoE, power by the I/O port is used.



NOTICE

Damage to the camera electronics

- Use only DC power supplies that comply with the camera specifications and that have insulated cases.
- When using external power supplies, pay attention to the alignment marks on the 10-pin TFM connector and socket. Inserting the plug in the wrong orientation might cause damage to the camera electronics and peripherals.
- For all cable connections, use only shielded cables to avoid electromagnetic interference.



External power supply

For a suitable external power supply, see www.alliedvision.com/en/support/accessory-documentation.

Powering the camera via PoE

Please note the following when using PoE NICs and PoE injectors with Allied Vision PoE-capable Alvim G5/G5X cameras:

Feature	Specification
Supported standard	IEEE 802.3af, Power Class 0
Cable category	We recommend you to use Category 6 cables for better performance.
PSE	Power Sourcing Equipment (PSE) must support data over all 4 pairs and must be rated for the intended link speed.

Table 90: Powering the camera via PoE

Software for your Alvium G5

Allied Vision software

Software packages provided by Allied Vision are free of charge and contain such as:

- Drivers
- SDK for camera control and image acquisition
- Examples based on the provided APIs of the SDK
- Documentation and release notes
- Viewer application to operate and configure the cameras



Download **Vimba X** from www.alliedvision.com/en/products/software/vimba-x-sdk. After installing, documentation is located in the **Vimba X** program folder.

Third-party software

In addition to the software provided by Allied Vision, numerous GigE Vision Standard compliant third-party software options can be used to extend functionalities, such as image processing and video recording.

Allied Vision's **Vimba X** is based on the GenICam standard. GenICam-based third-party software automatically connects with Vimba's transport layers.



Cognex VisionPro

Alvium GigE cameras comply with GigE Vision Standard V2.2.

The **eBus Universal Pro Driver** in **Cognex VisionPro** supports a previous V1.x version. Therefore, it cannot be used with Alvium cameras.

Please check if you can use **Vimba** (instead of **Vimba X**) and **Vimba Cognex Adapter for VisionPro** included in the download of **Vimba SDK** to replace the eBus driver.

We intend to provide an updated version of this software for use with **Vimba X**. Until then, if **Vimba** does not support all features required by your application, please contact support at www.alliedvision.com/en/about-us/contact-us/technical-support-repair/-/rma.

Camera interfaces



This chapter includes:

I/Os: Precautions	159
Back panel	160
I/O connector pin assignment	161
I/Os and GPIOs	162
Status LEDs	167

I/Os: Precautions



NOTICE

Damage by reverse polarity

If Alvium G5/G5X cameras are externally powered with reverse polarity, the cameras can be damaged.

Power Alvium G5/G5X cameras according to the specifications described in this chapter.



NOTICE

Damage by serial communication voltage levels

If you are using serial communication (UART, similar to RS232), keep voltage levels in the range defined in [Table 92](#) on page 161. Typical RS232 voltage levels (such as ± 10 VDC) are not supported without external circuitry.



I/O cables maximum length

The maximum length for I/O cables must not exceed 30 m.



Signal level

Consider this when you connect external devices to your camera, for example, to trigger lighting:

- The default signal level for isolated GPO2 is low at camera startup.
- The default signal level for non-isolated GPIO0 and GPIO1 is high at camera startup.

Use the **LineInverter** feature to configure I/Os and GPIOs for your needs.

Back panel

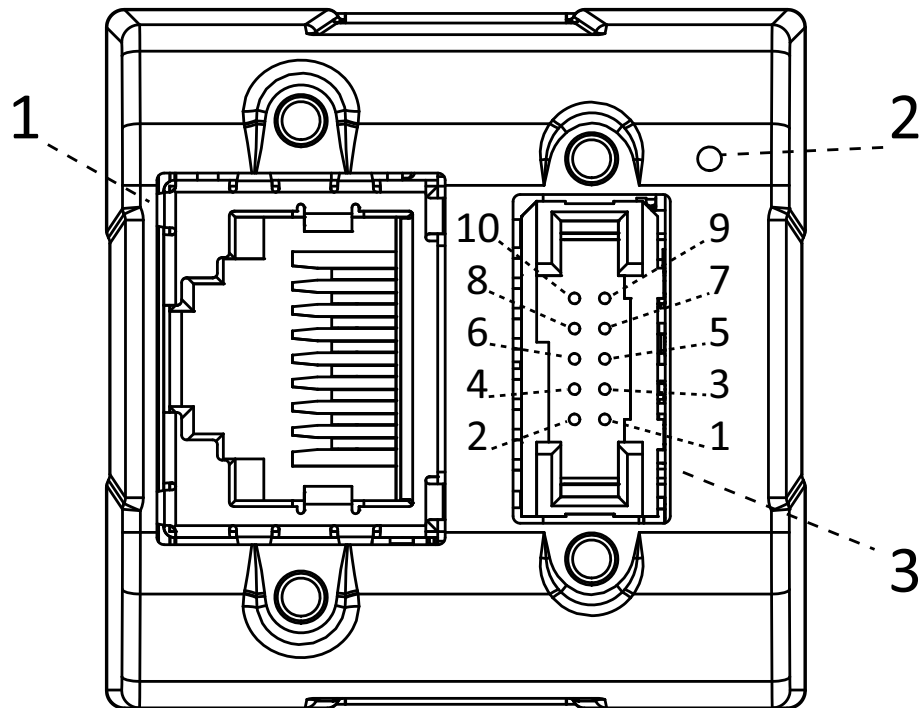

Figure 47: Back panel of camera

	Description
1	Ethernet port
2	LED
3	I/O connector

Table 91: Ports and LED



I/O connector

The I/O connector is 10-pin TFM connector type TFM-105-02-L-DH.

We recommend using cables by Allied Vision. If you are going to manufacture your own cables, see SFSD, ISDF, or SFM series at www.samtec.com.

Even though the TFM connectors' product naming differs between Alvium G1 and Alvium G5, both cameras use the same mating connectors.



I/O cables

For suitable I/O cables, see www.alliedvision.com/en/support/accessory-documentation.

I/O connector pin assignment

The general purpose I/O port uses a 10-pin TFM connector on the camera side.

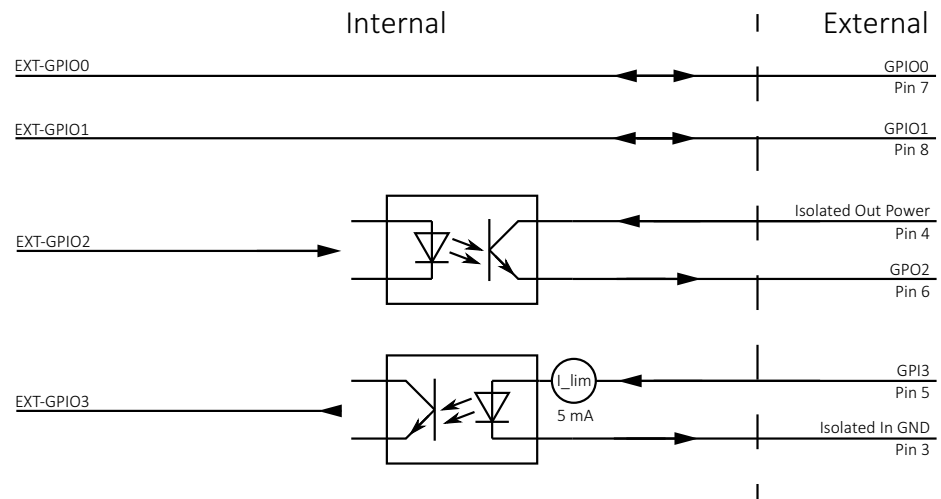

Figure 48: TFM I/O connector pin assignment

Pin	Signal	Direction	Level	Description
1	PWR-GND	IN	0 VDC	Supply Ground
2	PWR-IN	IN	10.8 to 26.4 VDC	Power supply voltage
3	OPTO-IN-GND	IN	0 VDC	Isolated input ground
4	OPTO-OUT-PWR	IN	max. 30 VDC	Power for isolated output
5	GPI3	In	$U_{in}(\text{high}) = 3.0 \text{ to } 24.0 \text{ V up to } 36 \text{ VDC}$ with 3.3 k Ω ext. resistor in series $U_{in}(\text{low}) = 0 \text{ to } 1.0 \text{ V}$	Isolated Input
6	GPO2	Out	Open emitter, max. 20 mA	Isolated Output
7	GPIO0	In/Out	$U_{in}(\text{low}) = -0.3 \text{ to } 0.8 \text{ VDC}$ $U_{in}(\text{high}) = 2.0 \text{ to } 5.5 \text{ VDC}$ $U_{out}(\text{low}) = 0 \text{ to } 0.4 \text{ VDC}$ $U_{out}(\text{high}) = 2.4 \text{ to } 3.3 \text{ VDC at max. } 20 \text{ mA}$	Non-isolated I/O (LVTTTL)
8	GPIO1	See Pin 7, GPIO0		
9	Reserved			
10	C-GND	PWR	0 VDC	Chassis ground and shielding

Table 92: TFM I/O connector pin assignment

I/O use for UART

Table 93 shows which values must be selected to control I/Os using LineSelector.

Signal	LineSelector (GenICam)	UART line
EXT-GPIO 0	Line0	UART Tx
EXT-GPIO 1	Line1	UART Rx
EXT-GPIO 2	Line2	Not applicable
EXT-GPIO 3	Line3	Not applicable

Table 93: Value settings to control I/Os using the LineSelector feature



Feature descriptions

For more information in LineSelector and SerialHub features, see the Alvium Features Reference at www.alliedvision.com/en/support/technical-documentation/alvium-gige-documentation.

I/Os and GPIOs

Isolated input description

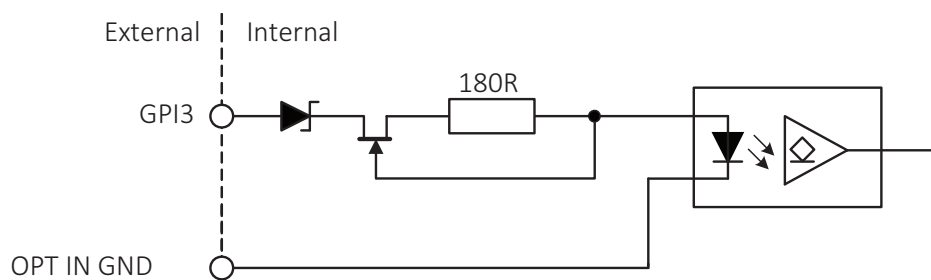

Figure 49: Input block diagram

The input can be connected directly to the system for voltages up to 24 VDC. An external resistor is not necessary.

Levels

Parameter	Value
U_{in} (low)	0 to 1.0 V
U_{in} (high)	3 to 24 V
Current (constant-current source)	3 to 4 mA

Table 94: Input parameters

Minimum pulse width

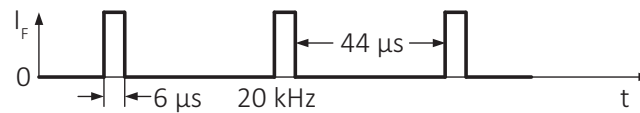

Figure 50: Minimum pulse width

Test conditions

The input signal was driven with 3.3 V and no external additional series resistor.

Isolated output description

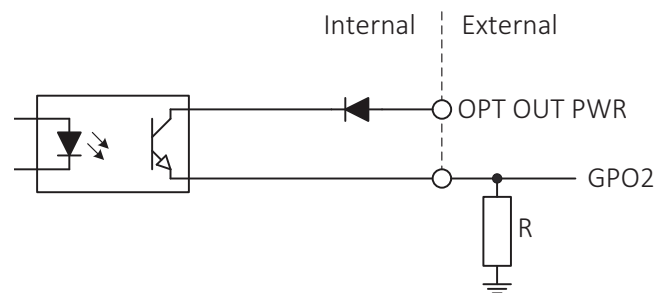

Figure 51: Output block diagram

Levels



NOTICE

Damage to the camera by high output current or voltage

Exceeding the maximum output voltage or current can damage the camera. Keep maximum output voltage below 24 VDC and output current below 20 mA.

Isolated out power	Resistor value ¹	
5 V	1.0 kΩ	at ~ 5 mA minimum required current draw
12 V	2.4 kΩ	
24 V	4.7 kΩ	

¹ A resistor is required when GPO2 is connected to a device with a high impedance < 5 mA draw.

Table 95: Isolated out power and external resistor

Switching times

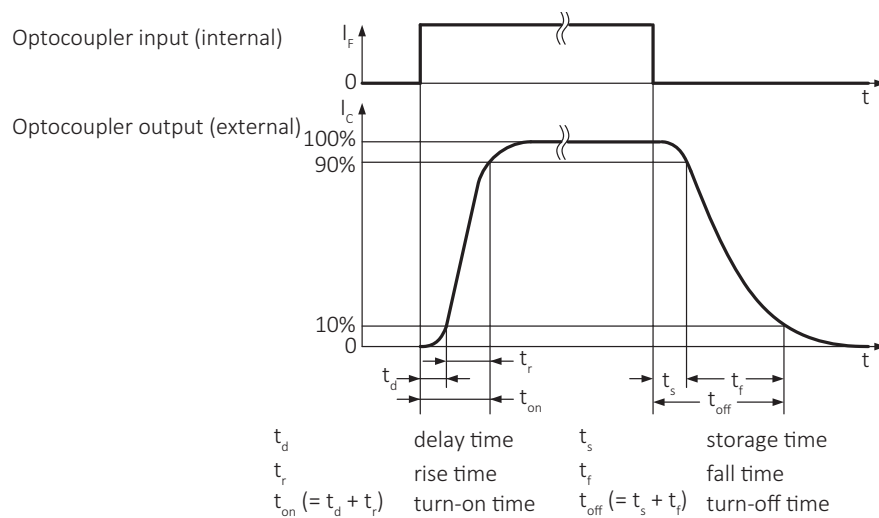

Figure 52: Output switching times

Parameter and value	
$t_d \approx 1 \mu\text{s}$	$t_s \approx 26 \mu\text{s}$
$t_r \approx 1 \mu\text{s}$	$t_f \approx 21 \mu\text{s}$
$t_{on} = t_d + t_r \approx 2 \mu\text{s}$	$t_{off} = t_s + t_f \approx 47 \mu\text{s}$ (t_{off} can deviate by $\pm 5 \mu\text{s}$)

Table 96: Output parameters

Test conditions

Output: external 2.4 kΩ resistor to GND, isolated out power set to 12 V.



Higher external values increase the times in the previous table.

Non-isolated GPIOs description

The camera has two non-isolated GPIOs that can be configured by software to act as inputs or outputs.

Alvium G5/G5X GPIOs use the push-pull technology to switch the signal level between low and high. For low levels, the signal is "pulled" down towards ground level. For high levels, the signal is "pushed" up towards VCC level.

Alvium G5/G5X GPIOs feature the CMOS push-pull output drivers and Schmitt trigger inputs with an internal pull-up resistor and a filter circuit, shown in [Figure 53](#). The push-pull GPIOs are able to source or sink current from an external pin.

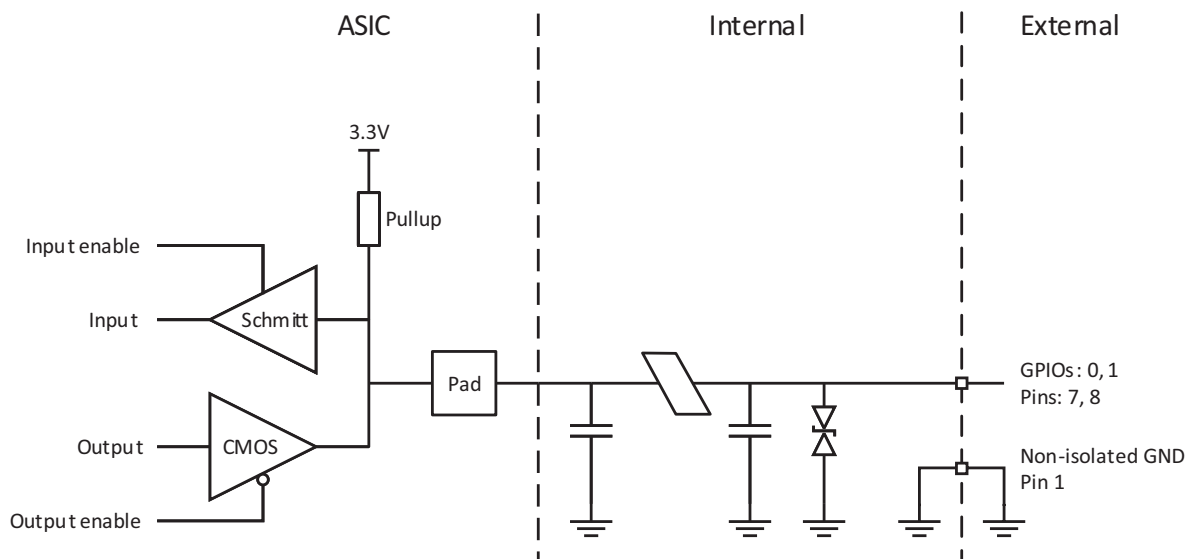

Figure 53: GPIOs block diagram

Input levels

The GPIOs can be connected directly to the system controlling the camera for voltages up to 5.5 VDC. An external resistor is not necessary.



NOTICE

Damage to the camera by high input voltage

Exceeding the maximum input voltage can damage the camera.

Keep maximum input voltage below 5.5 VDC.

Parameter	Value
U_{in} (low)	-0.3 to 0.8 VDC
U_{in} (high)	2.0 to 5.5 VDC
Undefined levels	0.8 to 2.0 VDC

Table 97: GPIOs as input, voltage levels

Output levels



NOTICE

Damage to the camera by high output current

The camera can be damaged when connected to a device that exceeds the specified maximum current or voltage. Keep the maximum current below 12 mA per output.

Parameter	Value
External output voltage U_{out} (low, Off state)	0 to 0.4 VDC
External output voltage U_{out} (high, On state)	2.4 to 3.3 VDC
Undefined levels	0.4 to 2.4 VDC
Maximum external output voltage	3.3 VDC
Maximum output current	12 mA

Table 98: GPIOs as output, current and voltage levels



Output voltage for U_{out} (high) = On state

The voltage level in the On state depends on the load current. Higher currents yield lower voltage.

Status LEDs

Alvium G5/G5X cameras have LEDs to signal in yellow, green, or red color.



LED settings

You can define LED settings with the `DeviceIndicatorLuminance` feature:

- A value of `10` enables LED signaling at the highest luminance level.
- Values below `10` reduce the luminance level.
- `0` disables LED signaling.

LED codes



LED codes	Behavior	Status
	Continuously active	Camera is initializing
	Continuously active	Camera is operational
	Continuously active	Error state

Table 99: LED codes



Yellow LED color

With yellow, a green and a red LED are active in parallel. Seen directly from behind, this appears as yellow; seen from an angle, you can see green and red separately.

Error state

If the camera signals an error, try the following to get the camera back to normal operation:

- Restart the camera.
- Should this fail, please contact support at www.alliedvision.com/en/about-us/contact-us/technical-support-repair/-rma.

Triggering and timings



This chapter includes:

Trigger signal flow	169
Trigger latency	169
Triggering with rolling shutter cameras	170

Trigger signal flow

Figure 54 shows a general diagram for the trigger signal flow. The external signal can be a physical source, such as light barrier as hardware trigger or a software trigger. This external signal starts the exposure of a frame. The end of exposure starts the readout. High levels show the active state of a signal.



Feature descriptions and firmware downloads

Alvium Features Reference: www.alliedvision.com/en/support/technical-documentation/alvium-gige-documentation

Firmware downloads: www.alliedvision.com/en/support/firmware-downloads.

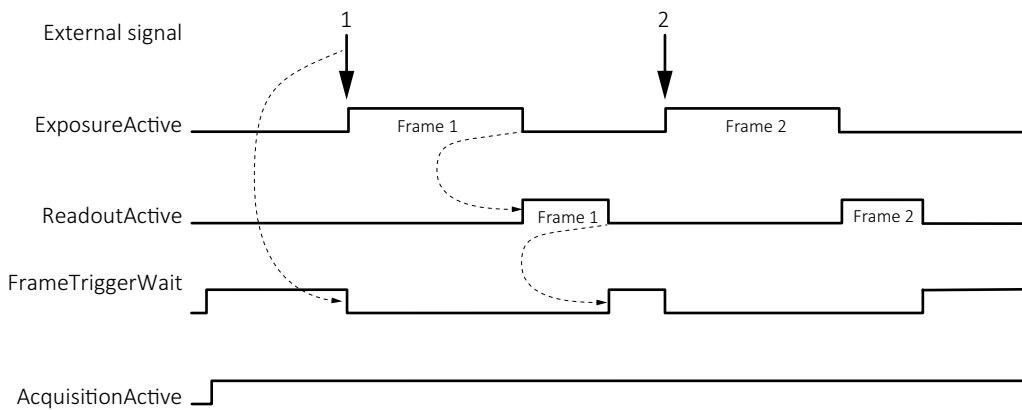

Figure 54: Schematic trigger signal flow

Term	Description
External signal	Electrical trigger signal starting the signal flow
<i>ExposureActive</i>	Exposing a frame
<i>ReadoutActive</i>	Reading out a frame
<i>FrameTriggerWait</i>	Waiting for a trigger
<i>AcquisitionActive</i>	Enables frame acquisition: Expose, read out data, or wait for triggers.

Table 100: Trigger signal flow terms

Trigger latency

In theory, a trigger creates an immediate response of the camera, depending on the cable length. In practice, the computer may add a delay that is mostly unpredictable, especially on Windows systems. In addition, camera electronics and sensors have a delay.

We recommend you to trigger on the rising edge for the fastest reaction time.

Electronic rolling shutter (ERS) cameras in this document also have exposure delay, depending on camera settings, see [Triggering with rolling shutter cameras](#) on page 170. Electronic rolling shutter is commonly called rolling shutter.

Triggering with rolling shutter cameras

This section describes triggering behavior for **Alvium G5-500m/c, G5-1240 m/c, and G5/G5X-2050m/c** cameras with rolling shutter sensor. Figure 55 shows how an external signal triggers exposure and readout for cameras with rolling shutter sensors. Like for global shutter sensors, readout has a constant duration, acquisition must be active to enable exposure, the end of exposure starts readout. ERS sensors run in cycles where **readout area** equals **exposure area**. Overlapping triggering is not supported. If exposure time is shorter than readout time, exposure starts with a delay:

Exposure start delay = exposure area – exposure time.

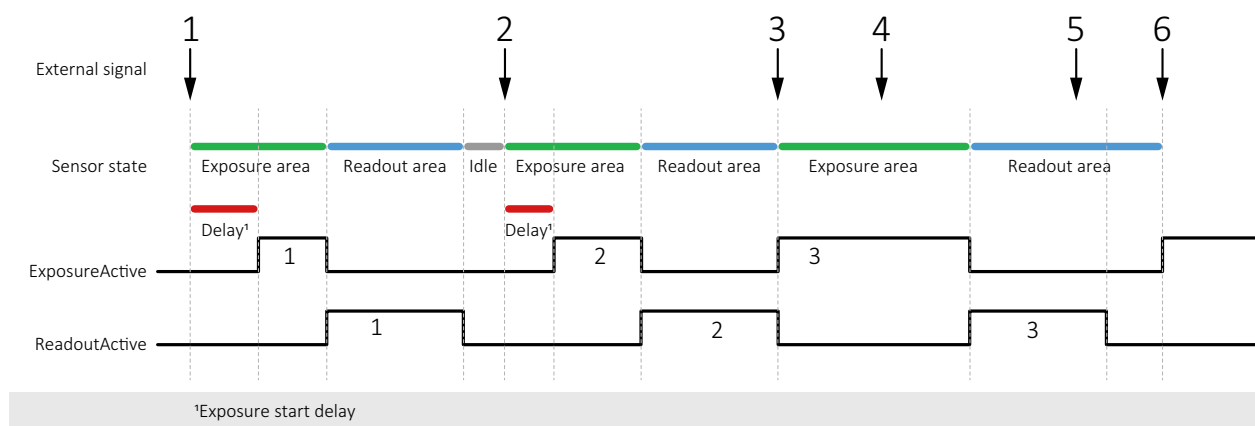

Figure 55: Triggering rolling shutter cameras

No	Conditions	Results
1	Exposure time is shorter than readout time.	Trigger 1 starts exposure 1 with a delay
2	Exposure time is shorter than readout time, but longer than for exposure 1.	Trigger 2 starts exposure 2 with a delay shorter than for exposure 1.
3	Exposure time is longer than readout time	Trigger 3 starts exposure time without a delay. Because the exposure area is longer, also the readout area is longer than for triggers 1 and 2
4	Exposure area is ongoing.	Trigger 4 is ignored.
5	Readout area is ongoing	Trigger 5 is ignored.
6	Readout area is finished. Exposure time is longer than readout time.	Trigger 6 starts exposure 6 without a delay

Table 101: Triggering results versus conditions



TriggerSelector values for rolling shutter cameras

Cameras with rolling shutter **can** be triggered using *AcquisitionStart*, *AcquisitionEnd*, or *FrameStart* for **TriggerSelector**.

Cameras with rolling shutter **cannot** be triggered using *ExposureStart* or *ExposureEnd* for **TriggerSelector**.

Ignored triggers

Alvium G5-500m/c, G5-1240 m/c, and G5/G5X-2050m/c

Changing parameters while acquisition is active leads to ignored triggers until the parameters get active.

Trigger features and UserSetDefault

See [Trigger features and UserSetDefault](#) on page 130.

Image data flow



This chapter includes:

Image data flow diagram	173
FPNC support	174

Image data flow diagram

Figure 56 shows image data processing for Alvim G5/G5X cameras in general.

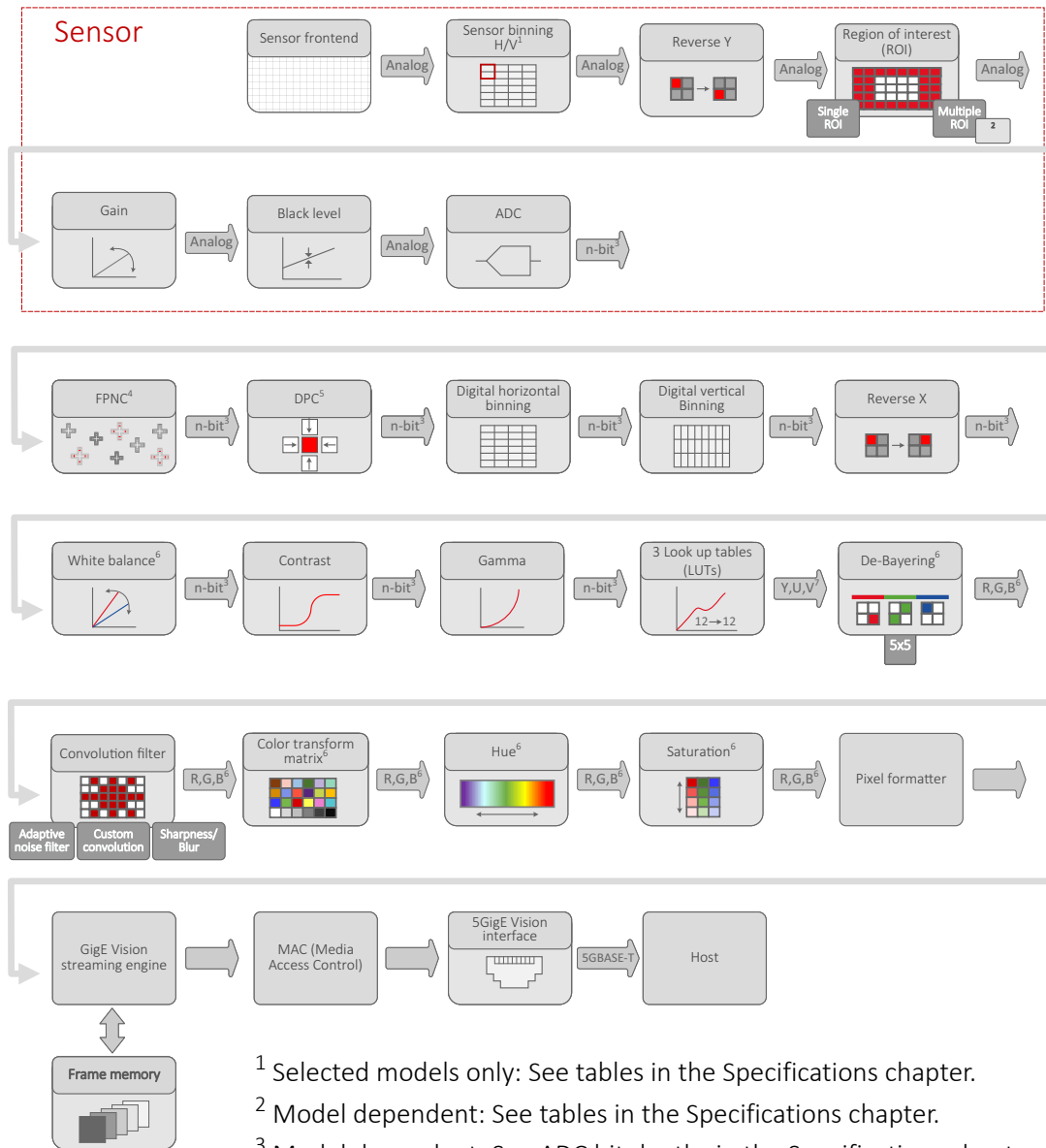

- ¹ Selected models only: See tables in the Specifications chapter.
- ² Model dependent: See tables in the Specifications chapter.
- ³ Model dependent: See ADC bit depths in the Specifications chapter.
- ⁴ Factory preset for FPNC = Fixed Pattern Noise Correction. See [FPNC support](#) on page 174 for supported models.
- ⁵ Factory preset for DPC = Defect pixel correction
- ⁶ Color models only
- ⁷ For monochrome models: Y only

Figure 56: Image data flow of Alvim G5/G5X cameras

Feature descriptions and firmware downloads

Alvium Features Reference: www.alliedvision.com/en/support/technical-documentation/alvium-gige-documentation

Firmware downloads: www.alliedvision.com/en/support/firmware-downloads.

FPNC support

Table 102 shows which Alvium G5 models support FPNC (Fixed pattern noise correction):

Alvium model	Sensor	FPNC support	Alvium model	Sensor	FPNC support
G5-052	IMX426	-	G5-511	IMX547	✓
G5-130 VSWIR	IMX990	-	G5-530 VSWIR	IMX992	-
G5-203	IMX422	-	G5-811	IMX546	✓
G5-240	IMX392	✓	G5-812 UV	IMX487	✓
G5-291	IMX421	-	G5-1240	IMX226	✓
G5-320 VSWIR	IMX993	-	G5-1242	IMX545	✓
G5-500	AR0521	✓	G5-1620	IMX542	✓
G5-507 Pol	IMX264	-	G5-2040	IMX541	✓
G5-508	IMX250	✓	G5/G5X-2050	IMX183	-
G5-508 Pol	IMX250	-	G5/G5X-2460	IMX540	✓
G5-510	IMX548	✓			

Table 102: FPNC availability by camera model

Firmware update



This chapter describes how firmware is updated on Alvium G5/G5X cameras.

Please note

You should update firmware only to change camera functions or fix known issues.

Consider: Any firmware update may not only add new features to a camera or fix known issues. It may also replace previous features or change camera characteristics. See firmware release notes for details.



Keep the camera connected

- Keep the camera and the computer running while you are executing a firmware update.
- If the camera is powered down during firmware update, it may get into a non-functional state. Recovery may not be possible.



Use only suitable firmware

If unsuitable firmware is used, the camera may get into a non-functional state.

- Only update to newer versions. Do not downgrade firmware to an older version, unless this has been explicitly communicated.
- We recommend updating the firmware to the next increment version only. Skipping versions may cause issues.

Firmware update with Vimba X

1. Download and install **Vimba X**.
The download includes Vimba X documentation.
2. Download the firmware (AVF file).



Downloads

- For **Vimba X**, see www.alliedvision.com/en/products/software/vimba-x-sdk.
- For firmware updates, see www.alliedvision.com/en/support/firmware.

3. Connect your Alvim camera to the host.
4. Execute the installer of the firmware updater.
The **Vimba X Firmware Updater** window opens, displaying your camera and the installed firmware version.
5. Continue with [Updating the firmware](#) on page 177.

Updating the firmware



Screenshots

The following instruction shows the firmware update on a **Linux** system. On **Linux** systems with other skins and on **Windows**, the GUI will look different.

The screenshots show an Alvium CSI-2 camera, but it applies to all interfaces.

1. Click **Open** to select the firmware for the update.

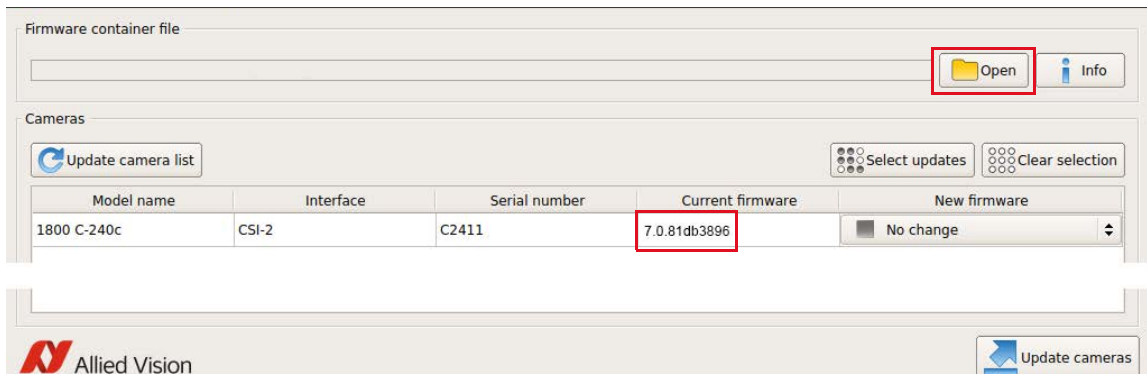

Figure 58: The camera and installed firmware are displayed

2. Select the firmware for the update from the drop-down menu.

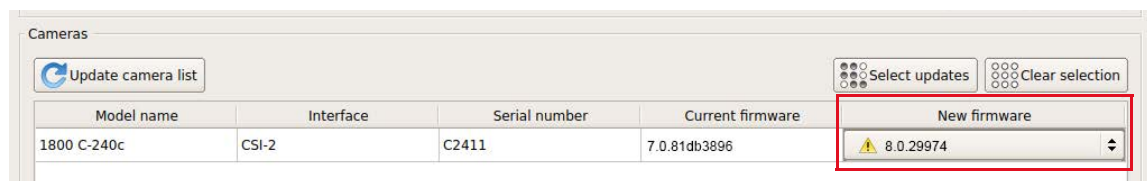

Figure 59: The firmware version is selected

3. Click **Update cameras**.



Figure 60: The update is being prepared

- Click **OK** to confirm.



Figure 61: The command to update the firmware is confirmed

The update progress is displayed.

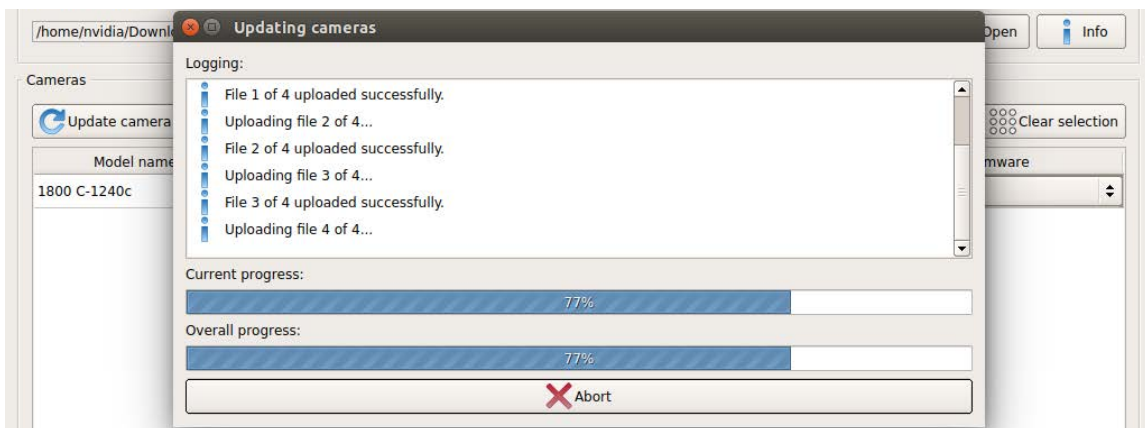

Figure 62: The update progress is displayed

- Click **Close** to confirm the completion of the update.

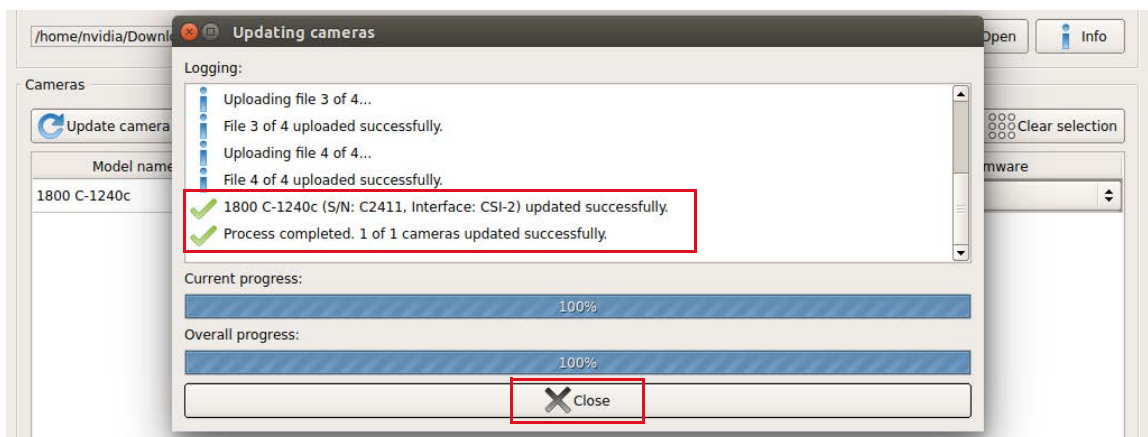

Figure 63: The update has been successfully completed

The camera is displayed with the updated firmware version.

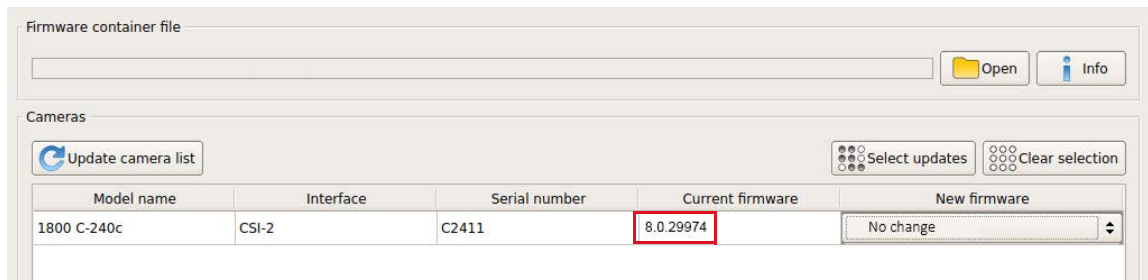

Figure 64: The updated firmware version is displayed

Error handling

If firmware update fails,

- The camera is not recognized by **Vimba X Viewer**.
- You can repeat the firmware update.

Should the firmware update not succeed, please contact support at www.alliedvision.com/en/about-us/contact-us/technical-support-repair-/-rma.

Performance and troubleshooting



This chapter includes:

Tips and tricks to connect 5GBASE-T	181
Optimizing performance	188
Reference system	195
Troubleshooting common issues	197

Tips and tricks to connect 5GBASE-T

Alvium G5/G5X cameras require different hardware and settings than 1000BASE-T cameras like Mako or Prosilica GT cameras. This section is going to help you set up applications more easily.



Dropped frames

The data rates output by current Alvium G5/G5X cameras may create very high load on your system. Make sure that you are using the latest firmware and software for optimum performance and reliability.



Troubleshooting

This section is covering most issues to enable proper camera operation. Should you need more help, see [Troubleshooting common issues](#) on page 197.

Hardware selection

The selection of hardware components is a key factor to minimize the risk of dropped frames. This can be achieved by such as the recommended NICs to reduce the workload for the CPU or by real-time operating systems.

All components must support the link speed required to transfer and process the data output by the camera. Otherwise, the link speed of the camera must be configured accordingly. If a part of the link on the path is under heavy load, a QoS (quality of service) can be used to ensure the needed throughput.



Recommended products

Recommendations for products are based on tests and positive experience. We plan to extend these recommendations in future.

CPU and RAM hardware

The number of CPU cores is important. Depending on the application, at least 4 physical CPU cores (8 Hyper-Threading cores) are required to limit the risk of dropped frames.

NIC hardware

We recommended using NICs that support Jumbo Frames with a size of 16,000 bytes, with one NIC per camera.

Recommended NICs

From our first experience, NICs with **Tehuti** and **Aquantia 10GBASE-T** or **5GBASE-T** chips work well. We recommend using:

- QNAP QXG-5G1T-111C (1-port, no PoE)
- QNAP QXG-5G2T-111C (2-port, no PoE).

We have found in first tests that current **Intel** NICs tend to create high CPU loads. This can result in lost packets inside the NIC or the network stack. Although **Intel** NICs may work in the correct host setup, we do not recommend using them with Alvium G5/G5X cameras. This limitation may not apply to all **Intel** NIC families or may be resolved in future generations.

We also tested NICs with **PoE**. Unfortunately, the cameras did not work reliably with these cards. Until further notice, we recommend using power injectors if you want to use PoE to power the camera.

Power injectors

When testing NICs that support Power over Ethernet (PoE), we have not yet found products that we can recommend with Alvium G5/G5X cameras. Therefore, we recommend using power injectors. For example, we recommend using Pihong POEA30U-1AT-5-R that has been tested successfully.

SFP adapters

Inexpensive RJ45 / xBASE-T SFP+ modules can be used to integrate cameras in fast (Q)SFP+ or (Q)SFP28 equipment. Please check that SFP+ modules support 5GBASE-T.

NIC hardware installation

Connect NICs directly to PCIe lanes of the CPU. If the NIC is connected to the chipset, ensure that the bandwidth between chipset and CPU is sufficient. Example: A NIC and an NVME SSD connected to the chipset, can create a bottleneck between chipset and CPU.

NIC firmware and drivers

Consider updating the firmware of the NIC, if available. Use newest drivers available.

For QNAP QXG-5G1T-111C and QNAP QXG-5G2T-111C, driver version 2.1.21.0 or newer should be used.

NIC driver settings



5GBASE-T mode

The 5GBASE-T mode must be enabled on some NICs and SFP modules.

- Enable sufficient bandwidth for NICs on the PCIe link: minimum 1 × 8 GT/s or 2 × 5 GT/s or 4 × 2.5 GT/s is required for one Alvim G5/G5X camera. Under **Windows**, you can use the PowerShell command `Get-NetAdapterHardwareInfo` to check whether the NIC uses the correct PCIe link speed and width.
- In systems with more than one NUMA (non-uniform memory access) node, the interconnect between the nodes can become a bottleneck. We recommend you to optimize the settings as suggested by the CPU and NIC manufacturer. If possible, lock the host software to the NUMA node connected to the NIC.

NIC driver settings under Linux



Receive buffer size

You can increase the receive buffer size to handle the data throughput

- Temporarily: `sysctl -w net.core.rmem_max=33554432`
- Permanently: Add to the file `/etc/sysctl.conf`:
`net.core.rmem_max=33554432`

The following commands can be used to find suitable settings. Note that these settings are **only temporary**. Adjust the corresponding system configuration files to change the settings permanently.

- Enabling Jumbo frames by setting the MTU size:
`ifconfig <dev> mtu 16000`
- Setting the IP address:
`ip a a 169.254.240.4/16 dev <dev>`
- Some 5GBASE-T NICs do not support auto negotiation. Setting the link speed manually:
`ethtool -s <dev> autoneg off speed 5000`
- Enabling **Ethernet Flow Control**:
`ethtool -A <dev> tx on rx on`
`ethtool -A <dev> autoneg on`
`ethtool -r <dev>`

NIC driver settings under Windows

- Maximize the Jumbo Frame size.
- Maximize the number of receive buffers.
- Switch off all non-required drivers, including filter drivers, in the network adapter settings. Mostly, the GigE filter driver included in **Vimba X** helps to increase the performance. Be aware that using a PCAP filter, such as **Wireshark**, has an impact on the performance.
- Optimize settings related to IRQs (interrupt requests) in the network driver settings (interrupt moderation).
- RSS (receive side scaling) should be enabled to improve the performance when multiple cameras or several network adapters are connected to the host.
- Enable **Ethernet Flow Control** for Rx and Tx traffic.



If Vimba and Vimba X are installed on the same PC

If you have installed **Vimba** and **Vimba X** on the same PC, see the Vimba X for Windows Release Notes to avoid issues with the GigE filter driver.

Operation system settings

Settings under Linux

Be aware of automated network configuration tools. If configured incorrectly, these tools can periodically remove the network settings and try to find a connection to the Internet. Use a static configuration and deactivate these tools to avoid issues.

Settings under Windows

- Disable any power-management that might impact the performance, especially on NICs, PCIe or the CPU.
 - Activate **Ultimate Performance** for power plan.
 - Disable sleep modes that turn off the screen.
- Avoid unnecessary CPU and network load, also on different network adapters where no camera is connected.
- Disable antivirus software if possible.
- Avoid system events causing lost packets, such as by plugging in USB devices.

Vimba X TL settings

Configuring the transport layer settings in **Vimba X**, can help to reduce dropped frames significantly. Look out for GenICam feature names starting with **GVSP**. Because every system is specific, individual experiments must be done.

This is an overview of GigE TL streaming features.



Transport layer feature descriptions

See the Alvium Features Reference: www.alliedvision.com/en/support/technical-documentation/alvium-gige-documentation.

GVSPDriverSelector

GVSPDriverSelector controls which software component is used to handle the streaming.

- **Windows:** Either the stream engine of the transport layer or the filter driver is used to receive and process the GVSP packets.
- **Linux:** Only the transport layer can be used.
- **Values:**
 - *Socket*: Use of the transport layers stream engine
 - *Filter*: Use of the filter drivers stream engine

Figure 65 gives an overview of the different stream handling methods.

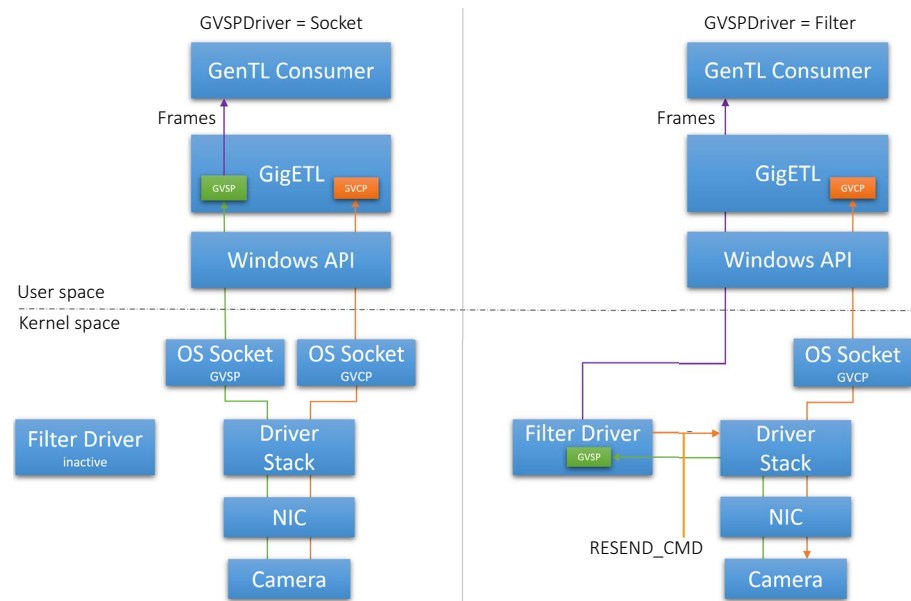

Figure 65: Stream handling with GVSPDriverSelector set to Socket or Filter

The filter driver minimizes the risk of lost frames substantially because it reduces the interactions between the user space and the kernel space, taking workload off the system:

When GVSPDriver is set to *Socket*, GVSP packets are processed in the user space. The downside of this approach: For each packet, system calls from the user space are required to enable GVSP packets pass from the kernel space.

Switching and transferring data between the kernel space and the user space is a time consuming process. This limits the number of GVSP packets a system can handle per second. A 5GBASE-T link can easily exceed this limit.

When `GVSPDriver` is set to *Filter*, the GVSP packets are processed by the filter driver that runs in the kernel space. This removes the linear dependency between system calls and GVSP packets. The filter driver copies the complete frame into the user space, coupling the number of system calls to the frame rate. Since the frame rate is substantially lower than the packet rate, the system has more resources left to handle the GVSP packets.

We recommend using the filter driver instead of the socket driver to increase performance and reliability.

If you cannot use the filter driver, you can reduce the number of GVSP packets per second. Increasing `GVSPPacketSize` is the only option to achieve this without reducing the performance of the camera.

GVSPPacketSize

`GVSPPacketSize` configures the total size of a GVSP packet, including the IP-, UDP- and GVSP headers.

The performance of the stream processing is largely determined by the number of received packets. [Figure 66](#) shows how `GVSPPacketSize` affects the CPU load during streaming at different packet sizes for the socket driver and the filter driver.

The diagram shows the total CPU load over all cores; on single cores, the difference between socket and driver is much larger. Values on your system may vary from values measured on our test system, but the relation is the same.

The packet size is inversely proportional to the number of packets per second. [Figure 66](#) shows that increasing the packet size reduces the number of packets, minimizing the risk of lost frames.

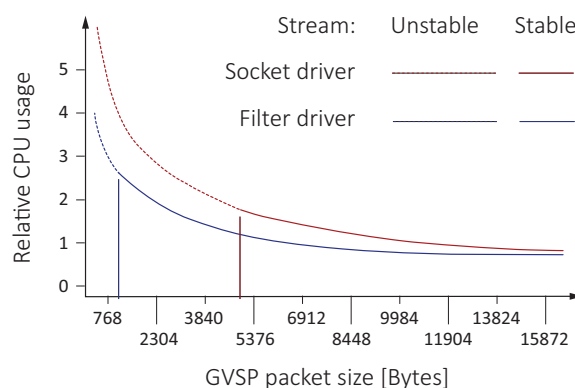

Figure 66: GVSPPacketSize versus CPU usage while the camera is streaming

Notes

We recommend allowing the maximum packet size possible. To determine the maximum packet size supported by your system, the Vimba X APIs include an automatic detection: Executing the `GVSPAdjustPacketSize` command first negotiates with the camera for the best possible packet size, then automatically sets `GVSPPacketSize`.

In addition, **Vimba X Viewer** automatically adjusts the packet size by default.

If the detected size is 1500 Bytes or less, ensure that Jumbo Frames are enabled on the host. Jumbo Frames must be enabled on all active Ethernet components.

GVSPBurstSize

GVSPBurstSize configures the number of GVSP packets that are processed at once before further checks, like missing packet detection, are executed.

Note: Currently the stream performance is not significantly affected. We recommend using the default value of **1**.

GVSPHostReceiveBufferSize

GVSPHostReceiveBufferSize controls the socket buffer space used to receive GVSP packets. The operating system adjusts the socket buffer continuously. The value may be limited internally by the operating system. See the `SO_RCVBUF` documentation of the operating system.

Note: This feature cannot be used with the filter driver.

GVSPTimeout

GVSPTimeout is used to react on a possible streaming interruption. If no GVSP packet is received during the last **GVSPTimeout** milliseconds, the stream engine forces a resend of currently missing GVSP packets.



Dropped frames with certain ROIs

With certain ROIs, dropped frames may occur. This can mostly be avoided when **GVSPTimeout** is set to $1/\text{frame rate}$.

GVSPtiltingSize

GVSPtiltingSize is used to cancel the reception of a single frame if a certain number of GVSP packets of the following frame has already been received.

The frame is marked as incomplete and returned to the GenTL consumer.

GVSPMaxRequests

GVSPMaxRequests is used to configure the maximum amount of `RESEND_COMMANDS` requested for a missing GVSP packet. Setting the feature to **0** disables the GigE Vision resend mechanism. The transport layer or filter driver does not request the re-transmission of any missing GVSP packet.

GVSPMissingSize

GVSPMissingSize is used to cancel the reception of a single frame if the resend limit **GVSPMaxRequests** is reached for too many packets. The frame is marked as incomplete and returned to the GenTL consumer.

Configuring the resend behavior

`GVSPMaxLookBack` and `GVSPMaxWaitSize` can be used to configure the "timing" of `RESEND_CMDs`.

GVSPMaxLookBack

`GVSPMaxLookBack` can be used to delay the first `RESEND_CMD` for a missing GVSP packet by X packets.

GVSPMaxWaitSize

`GVSPMaxWaitSize` can be used to delay the `RESEND_CMD` for the same missing GVSP packet. The transport layer or the filter driver waits until `GVSPMaxWaitSize` of packets has been reached before requesting a resend for the same packet again.

Example:



`GVSPMaxLookBack = 1 | GVSPMaxWaitSize = 2 | GVSPMaxRequests = 2`

Figure 67: Controlling the resend of packets

Sharing network bandwidth

We recommend using point-to-point links for best performance. If you must aggregate several cameras over a common link, add an offset to the calculated throughput. In fact, a shared 10G link can limit the performance of two Alvium G5/G5X cameras connected.

Optimizing performance

Image transfer with rolling shutter cameras

Alvium G5-500m/c, G5-1240 m/c, and G5/G5X-2050m/c

If acquisition is started and stopped in a short sequence, no image is transferred to the host. The duration cannot be predicted, because it depends on various factors.

Parameter changes

Alvium G5-500m/c, G5-1240 m/c, and G5/G5X-2050m/c

If parameters are changed while these cameras are streaming, the following effects can occur.

Stopped streaming

When `AcquisitionMode` set to `MultiFrame`: If cameras are triggered by `AcquisitionStart`, the streaming stops when parameters are changed.

For `MultiFrame` acquisition, we recommend to you stop streaming before you change parameters.

Frame rate jitter

Generally, some parameters can be changed during exposure without affecting the timing. For models with ON Semiconductor AR sensors and rolling shutter sensors, a different behavior must be considered for **camera operation in freerun mode without triggering**:

Changing parameters during exposure leads to frame rate jitter. When parameters are entered, the next frame starts only after readout and sensor reconfiguration delay are finished. When the camera is run in `ExposureAuto` mode, the actual frame rate is less than the calculated value for the corresponding exposure time. Consider frame rate jitter for your application, including a gap between `ExposureActive` signals.

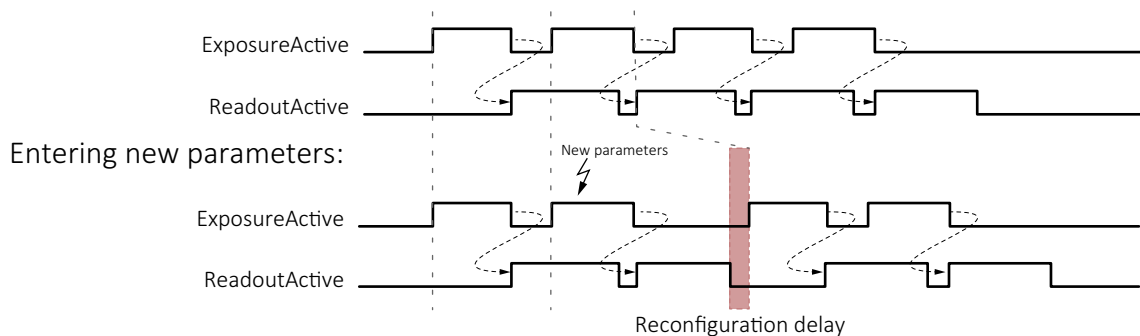

Figure 68: Delayed exposure due to parameter changes



Parameter changes in triggered mode

See [Ignored triggers](#) on page 171 for more information.

Value changes by feature interdependencies

The conversion between time and clock cycles affects control values. Features for pixel format, bandwidth, ROI, exposure time, and triggering are related to each other. Changing values for one feature can change values for another feature. For example, frame rates can be reduced when `PixelFormat` is changed subsequently. [Figure 69](#) shows the interdependencies.

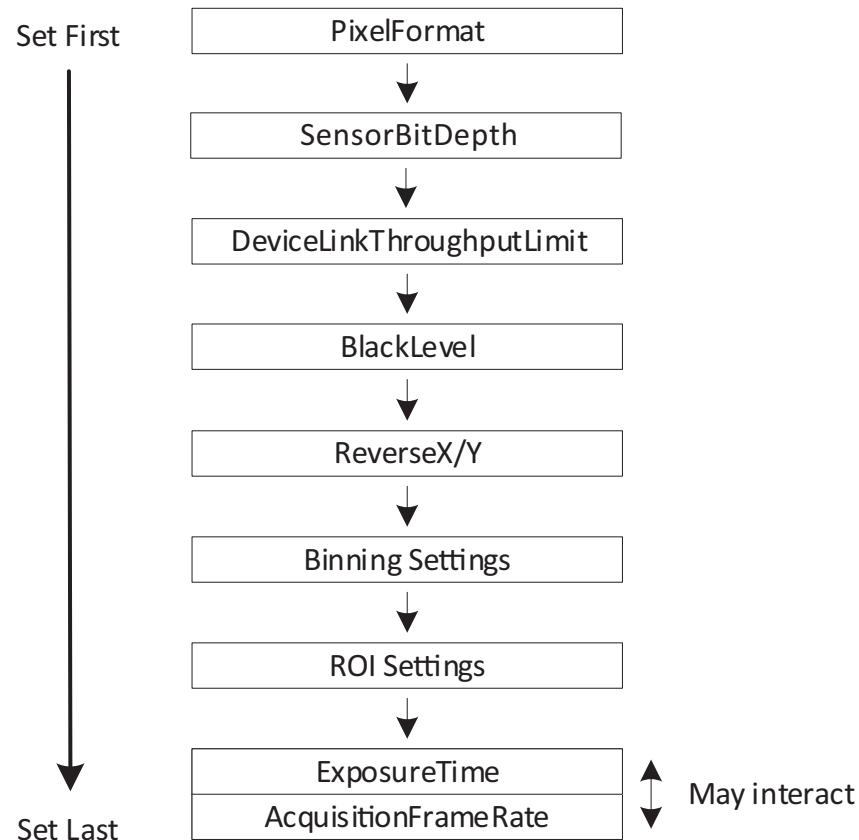

Figure 69: Interdependencies between features

Effects for the interdependent features

Changing one control's value affects other control's values, such as:

If: `Height` value is changed.

Then: Other values may be affected, such as for `AcquisitionFrameRate` and `ExposureTime`.

We recommend you to consider:

- The more features you adjust, the more current values deviate from previously set values.
- The same effects that apply to `ExposureTime`, also apply to `AutoExposure`.
- To avoid readjustments, apply settings in the order shown in [Figure 69](#).

Impact by other features

Input	Output	
	Exposure time values	Frame rate
AcquisitionFrameRate	Not affected	Affected
ExposureTime	Affected as expected	Affected
DeviceLinkThroughputLimit	Affected	Affected
Height	Not affected	Affected
Width	May be affected	May be affected

Table 103: Impact by other features

Exposure times and frame rates with Sony IMX rolling shutter cameras

Alvium G5-1240 m/c and G5/G5X-2050m/c

Generally, long exposure times result in low frame rates because one is roughly the inverse of the other. For Alvium G5/G5X cameras with Sony IMX RS sensors:

- The range of available frame rates depends on the exposure time.
- The exposure time must be increased when low frame rates are used.
- The available range for frame rate values depends on the exposure time. If by changing the exposure time, the previous frame rate is moved out of the available range, the frame rate is adjusted automatically.

Dark current compensation

All sensors accumulate dark current in the pixels. Dark current increases the signal level and black level. Most sensors in Alvium G5/G5X cameras compensate for this.

If cameras are operated at high temperatures or long exposure times, compensation reaches its limits. The typical compensation mechanism uses a **margin** to compensate for dark current. This works only until dark current reaches the size of the margin. The following table shows the relation of the margin and accumulated dark current for a pixel in 8-bit mode with a maximum value of 255.

Effective signal versus noise	Description
	The pixel has accumulated no dark current, the margin has maximum size.
	The pixel has accumulated some dark current, reducing the size of the margin.
The following images show a pixel that has accumulated a higher dark current than the margin.	
	The pixel has accumulated dark current, the margin reduces to 0. <ul style="list-style-type: none"> • Dark current compensation stays active. • Maximum saturation signal decreases. • Fixed pattern noise increases. This sensor-internal compensation is typically used in the analog domain.

Table 104: Accumulated dark current affecting the effective image signal

Additional compensation

If compensation limits are reached and you cannot decrease operating temperature or exposure time, what can you do to keep signal quality high?

You can increase the margin size by using gain, with the following side effects:

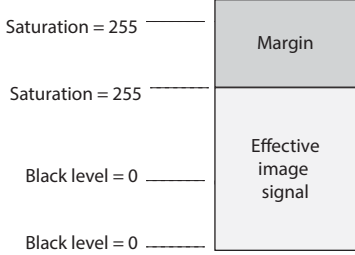
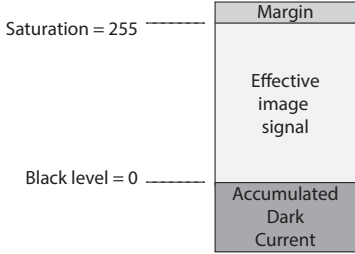
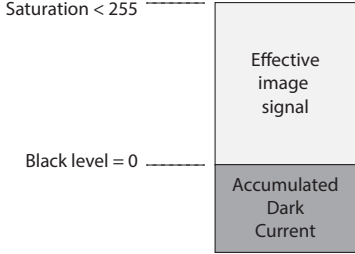
- To give space to a larger margin, the effective pixel capacity decreases.
- White and light gray values are shifted down to gray.

Shutter types affecting image readout

Most Alvium G5/G5X camera models are operated using global shutter (GS):

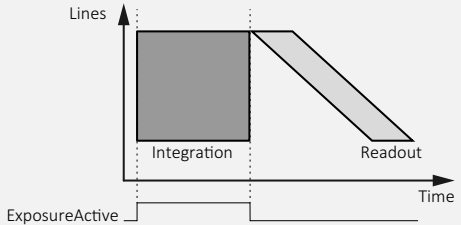
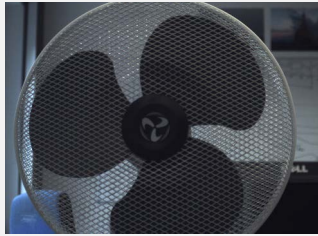
Property	Line readout	Moving image
Global shutter (GS)		

Alvium G5-500 models use rolling shutter (RS). Alvium 1800 G5-1240 and G5/G5X-2050 models offer global reset shutter (GRS) in addition:



Property	Rolling shutter (RS)	Global reset shutter (GRS)
Line readout		
Line exposure start	Deferred from line to line	Common for all lines
Line exposure time	Common for all lines	Increases from line to line
Image acquisition of moving objects		
Image brightness	Constant over the image	Varying over the image
Moving objects	Distorted shape	Shape without distortion
Typical application	Static objects	Moving objects
Compensation	Use an additional mechanical shutter or use a strobe light:	
		

Table 105: Shutter types affecting image readout

DevicePowerSavingMode

If you want to pause camera operation, you can use `DevicePowerSavingMode` to reduce the power consumption of Alvim G5 cameras.

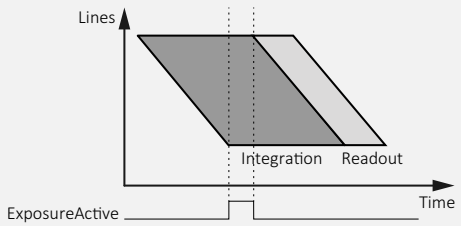
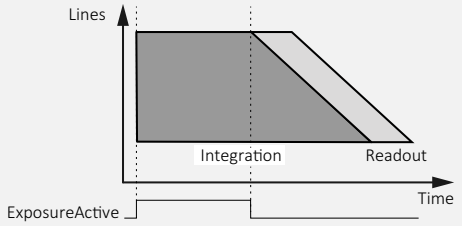
You can select between standard power use and *StandbyMode*:

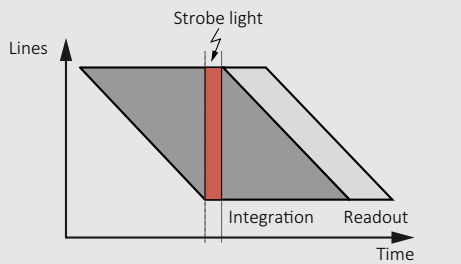
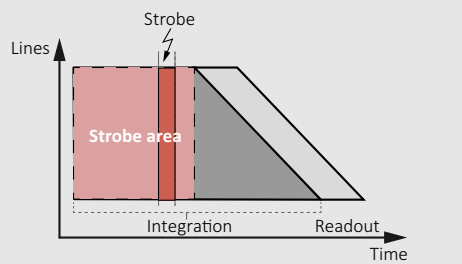
Values	Description
<i>Disabled</i>	The camera uses standard power (default).
<i>StandbyMode</i>	Camera functions are disabled to reduce power consumption. However, the control channel is maintained active: The camera can still be controlled by GenICam features.

Table 106: Options for `DevicePowerSavingMode`



Returning to standard power mode

Use `DeviceReset` command to switch from *StandbyMode* back to *Disabled*.

Operating systems and bandwidth

If the camera data output exceeds the bandwidth supported by the host computer, images may be corrupted. This section gives some background information to enable proper image transfer.

DeviceLinkThroughputLimit

`DeviceLinkThroughputLimit` controls the maximum bandwidth of the data streamed out by the camera. Consider that **Vimba X Viewer** does not gray out values that exceed the bandwidth supported by the host computer.



Feature description for `DeviceLinkThroughputLimit`

See the Alvim Features Reference: www.alliedvision.com/en/support/technical-documentation/alvim-gige-documentation.

Hardware and bandwidth

For a smooth data transfer of Alvim G5/G5X cameras, the host computer must be equipped with a high-bandwidth 5GBASE-T compliant NIC. We recommend using direct point-to-point links from camera to NIC for best performance. See [Recommended NICs](#) on page 182.

Vimba X settings

During freerun, Alvim G5/G5X cameras do not automatically adapt the frame rate to the limits of your system, including the NIC. If the data rate is too high, it receives corrupted frames. The image transfer status in **Vimba X Viewer** is signaled as **Running**. However, the corrupted frames are not displayed. For a solution, see [Camera cannot acquire images](#) on page 198.

Reference system

We have tested available frame rates on a desktop PC. Cameras were operated in *AquisitionMode = Continuous*, frame rates were measured using **Raspberry Pi** and **pigpio library**.



More information on pigpio library

For more information on pigpio library, see <https://abyz.me.uk/rpi/pigpio/index.html>.

Stated values were measured for bandwidths of 525 MByte/s, 400 MByte/s, and 300 MByte/s for [Operation for maximum frame rates](#), using the following test setup:

Component	Property
Operating system	Windows 10 Pro Version 1903, Build 18362. 1256
Work station	Dell Precision T5610
System type	x64-based PC
CPU	Intel(R) Xeon(R) CPU E5-2620 v2 @ 2.10GHz, 2095 Mhz, 6 Cores, 12 logical processors
BIOS	Dell Inc. A07, 4/29/2014
SM BIOS Version	V2.7
RAM	16 GB DDR3 DIMM (2 x 8 GB), 1600 MHz
Total virtual memory	18.3 GB
Page file space	2.38 GB
Kernel DMA Protection	Off
Virtualization-based security	Not enabled
Hype-V enabled for	<ul style="list-style-type: none"> • VM Monitor Mode Extensions • Second Level Address Translation Extensions • Virtualization Enabled in Firmware • Data Execution Protection
Graphics controller	NVIDIA NVS 310, driver 10.18.13.5362, 512 MB DDR3 PCI-Express
Hard discs 1,2 (RAID 1 system)	Seagate Desktop HDD S-ATA 7200 rpm, 1 TB, firmware CC45
NIC	Marvel FastLinQ Edge 10Gbit Network Adapter
NIC firmware	V3.1.109
Ethernet driver	Marvel Semiconductor Inc. 3.0.18.0

Table 107: Test setup components

Feature values

Source	Feature	Value	Comments
Camera	DeviceLinkThroughputLimitMode	<i>On</i>	Not applicable
	DeviceLinkThroughputLimit	615MByte/s ¹	5GBASE-T NICs
		115MByte/s ¹	1000BASE-T NICs
Transport layer	GVSPDriverSelector	<i>Filter</i>	Windows only
	GVSPPacketSize	16334	Vimba X default
	GVSPBurstSize	1	
	GVSPHostReceiveBufferSize	Not applicable	See footnote ²
	GVSPMaxLookBack	30	Vimba X default
	GVSPMaxWaitSize	100	
	GVSPMissingSize	256	
	GVSPtiltingSize	100	
	GVSPTimeout	70	

¹ These values enable the host to request resent packets and sent command packets.

² This feature is disabled when **GVSPDriverSelector** is set to *Filter*.

Table 108: Feature values



Description for camera and transport layer features

See the Alvium Features Reference: www.alliedvision.com/en/support/technical-documentation/alvium-gige-documentation.

Troubleshooting common issues

Camera is not powered

Camera or system issue?

When the camera is connected, the [Status LEDs](#) signal the camera status. If the LEDs of a connected camera are not illuminated, check with a working camera.

Power supply

If using a custom power supply, ensure that

- The adapter and wire gauge are rated 1 A at 12 VDC (lower current for higher voltages).
- The TFM connector is supplied with minimum 10.8 VDC despite voltage drop across the cabling.

Camera is not detected in the viewer

The camera is powered correctly, but it is not detected in the viewer.

Ethernet cabling

Damaged or poor quality Ethernet cabling can result in no cameras found, dropped packets, decreased bandwidth, and other problems. Use Category 6 or higher rated Ethernet cabling.

NICs and NIC ports

NICs or Ethernet adapters using Intel I219-LM chipset may not activate the link when an Alvim G5/G5X camera is connected directly. As a workaround, connect the camera to a different network adapter.

Ethernet adapter settings

Return to [IP settings](#) on page 153, which describes how to adjust the IP address of the host adapter. Do not use gateways on your NIC. Connect a single camera directly to your NIC.

Ensure that IP address of the adapter is on the same subnet as the camera. If not, return the adapter address to the Auto IP configuration. A sample IP configuration for the camera and adapter is shown below.

	Adapter	Camera
IP address	169.254.23.2	169.254.43.3
Subnet mask	255.255.0.0	255.255.0.0

Table 109: Sample IP configuration

Camera cannot acquire images

The camera is detected in the viewer but does not acquire images.

Revert the camera settings to factory default: In the controller window of **Vimba X Viewer**, under *SavedUserSets*, set *UserSetDefaultSelector = Default*, click *UserSetLoad*, and click the *Execute* button.

If StatFramesDelivered / StatPacketsReceived = 0

- Click on *Stream > Statistics* to view camera freerun statistics.
- Disable your firewall on Ethernet adapter connected to camera to avoid blocking incoming traffic.
- Ensure that in **Vimba X Viewer**:
AcquisitionFrameRateEnable = True
TriggerSelector = FrameStart
TriggerSource = Software or *LineX*
- Consider that some trigger modes require a trigger event to capture frames.

If StatFramesDropped ≠ 0

Packets are incoming, but all dropping.

Enable Jumbo Frames on your adapter, see [Adjusting the NIC driver settings](#) on page 154.

If StatFramesDelivered value increases, but images are black

- Ensure your scene is sufficiently lit.
- Increase the exposure time value, using *ExposureTimeAbs*.
- Ensure the lens is properly installed and the lens cap has been removed.



Application support

If you are still having problems, please contact support at www.alliedvision.com/en/about-us/contact-us/technical-support-repair-/-rma.

Avoiding dropped packets

- Check the Ethernet cable. A damaged cable often causes the link to negotiate a lower speed as fallback.
- **Windows:** Disable auto updates and telemetry.
- Use the recommended NICs, see [Recommended NICs](#) on page 182.
- Use the latest NIC driver from the NIC manufacturer.
- Enable Jumbo Frames/Packets on the NIC. Larger packets result in less overhead on the host CPU. See [Enabling Jumbo Packets](#) on page 154.



Available packet size

Be aware that the effective maximum packet size is limited to the biggest size supported by all network devices on the path.

- Enable Ethernet Flow Control on NICs and switches, see [NIC driver settings](#) on page 183.
- Disable the firewall if no filter driver is used.
- If possible, use a dedicated network infrastructure:
 - Ideally, each camera has a point-to-point connection to a dedicated network adapter in the host.
 - Separate camera networks from other networks.
 - Avoid aggregating multiple cameras over a single network link if possible. The more cameras use a common link, the lower becomes the usable total system throughput, caused by packet losses or less effective processing on the host side.
- **Linux only:** Run as root, allowing the OS to boost the priority of the Allied Vision driver thread, and the driver to bind directly to the NIC adapter. Users who feel running as root compromises their system security may find the following implementation satisfactory:
 - Set the executable owner as root.
 - Set the “setuid” permission bit on the executable.
 - In code, when application starts use `capset()` to release all but these privileges: `CAP_SYS_NICE`, `CAP_NET_ADMIN`, `CAP_NET_BROADCAST`, `CAP_NET_RAW`. The application will start with all root privileges, but it will drop them immediately after startup.

Index

A

AcquisitionActive	169
Auto IP configuration	197

B

back panel	160
------------------	-----

C

camera connectors	160
camera hardware	158
camera mounting	146
Category 6	155, 197
connectors	158
copyright	39
current and voltage	42

D

dark current compensation	192
DevicePowerSavingMode	194
digital binning	56
dimensions	123
document	
conventions	33
history	26
overview	15

E

ESD	42
-----------	----

F

FCC	37
feature availability	131
firmware update	175
Flow Control	
Linux	183
Windows	184
frame rates > reference settings	52

G

general safety notes	39
GenICam	49
GigE Vision	49
global reset shutter (GRS)	193
global shutter (GS)	193

H

heat dissipation	40
------------------------	----

heat sink mounting	145
host computer	
configuring	152
connecting	155
connecting 5GBASE-T	181
Jumbo Packets	154
NIC driver installation	152
NIC driver settings	154
NIC IP address	153

I

I/Os, GPIOs	
connector pin assignment	161
description	162
image data flow	172
interfaces	158
IP class	49
IR cut filter	127

J

Jumbo Packets	154
---------------------	-----

L

lens	
focal length vs. FOV	133
maximum protrusion	45, 126
mounting	148
mounts	126
vignetting	134

M

mass	123
MutipleRegions	57

N

NIC	
safety	43
troubleshooting	197

P

power consumption > reference settings	60
--	----

R

readout modes	53
reference system	195
ROI frame rates	52
rolling shutter (RS)	193

S

safety	2, 4, 8, 14, 33, 40
camera power	42
electrical connections	42

heat dissipation	40	trigger signal flow	169
heavy lenses	41	triggering with RS cameras	170
lens mounts	40	troubleshooting	180
lens protrusion	45	bandwidth	194
mounting cameras	41	dark current compensation	192
NIC	43	dropped packets	199
optical components	44	feature interdependencies	190
sensor	44	frame rate jitter	189
sensor ADC readout modes	53	parameter changes	189
sensor binning	56	performance test	195
sensor cleanliness (definition)	45	streaming is stopped	189
sensor position accuracy	128	troubleshooting common issues	197
sensor shutter types	54	U	
shock and vibration	49	UART	162
specifications	48	user sets	130
standards applied	49	V	
status LEDs	167	vignetting	134
streaming is stopped	189	W	
T		white balance default	122
technical drawings	123		
torque values	146		
trigger latency	169		