



Note: Lenses are not part of this product.

User Guide

V4.8.2

2023-Jul-10

**Quick links**

- [Introduction](#) on page 25
- [Contact us](#) on page 15
- [Contents](#) on page 16

Read before use

EN - English

Safety

Before using the camera, read these safety instructions. Observe the warnings at all times. Use the camera only as stated in the [Intended use](#) on page 45.

**CAUTION****Risk of burns**

A camera in operation can reach temperature levels which could cause burns.

**CAUTION****Injury by falling cameras or lenses**

A falling camera or lens can cause injury.

**CAUTION****Risk of cuts by sharp edges of lens mounts**

The threads of the lens mount can have sharp edges.

Intended use

Intended use of Allied Vision product is the integration into vision systems by professionals. All Allied Vision product is sold in a B2B setting.

Cameras without closed housings

Cameras without housing or with incomplete housing must be shielded against EMC emission by professionals according to local EMC provisions.

DA - Dansk

Sikkerhed

Læs sikkerhedsanvisningerne, før kameraet bruges. Overhold alle advarsler. Brug kun kameraet som anført i [Intended use](#) på side 45.



FORSIGTIG

Forbrændingsfare

Når kameraet bruges, kan det blive meget varmt og forårsage forbrændinger.



FORSIGTIG

Kvæstelser, hvis kameraet eller linser falder ned

Falder kameraet eller linsen ned, kan dette forårsage kvæstelser.



FORSIGTIG

Fare for snitsår på linsemodulets skarpe kanter

Linsemodulets gevind kan have skarpe kanter.

Tilsigtet brug

Allied Vision produktets tilsigtede brug er en indbygning i et visionssystem, udført af fagfolk. Alle Allied Vision produkter sælges i B2B.

Kameraer uden lukket hus

Kameraer uden hus eller uden komplet hus skal beskyttes mod EMC emissioner iht. lokale EMC bestemmelser.

DE - Deutsch

Sicherheit

Bevor Sie die Kamera benutzen, lesen diese Sicherheitshinweise. Beachten Sie diese Hinweise immer. Verwenden Sie die Kamera nur wie beschrieben in [Intended use](#) auf Seite 45.



VORSICHT

Gefahr von Verbrennungen

Im Betrieb kann die Kamera Temperaturen erreichen, die zu Verbrennungen führen.



VORSICHT

Verletzung durch fallende Kameras oder Objektive

Eine fallende Kamera oder ein fallendes Objektiv kann Verletzungen verursachen.



VORSICHT

Schnitte durch scharfkantige Objektivgewinde
Objektivgewinde können scharfe Kanten haben.

Bestimmungsgemäßer Gebrauch

Allied Vision Produkte sind bestimmt für die Integration in Bildverarbeitungssysteme durch Fachpersonal. Alle Allied Vision Produkte werden in einer B2B-Umgebung verkauft.

Kameras ohne geschlossenes Gehäuse

Für Kameras ohne Gehäuse oder mit unvollständigem Gehäuse muss die Abschirmung gegen EMV-Emissionen gemäß den örtlichen EMV-Bestimmungen durchgeführt werden.

ES - Español

Seguridad

Antes de utilizar la cámara lea estas instrucciones de seguridad. Observe las advertencias en todo momento. Utilice la cámara solo tal y como se estipula en el [Intended use](#) a pagina 45.



ATENCIÓN

Riesgo de quemaduras

Una cámara en funcionamiento puede alcanzar temperaturas que podrían provocar quemaduras.



ATENCIÓN

Lesiones en caso de que las cámaras o las lentes se caigan

Si una cámara o una lente se cae puede provocar lesiones.



ATENCIÓN

Riesgo de cortes debido a los bordes afilados del objetivo

Las roscas de los objetivos pueden tener bordes afilados.

Uso previsto

El uso previsto del producto Allied Vision es la integración en el sistema de visión por parte de profesionales. Todos los productos Allied Vision se venden dentro de una relación B2B.

Cámaras sin carcasa cerrada

Las cámaras sin carcasa o con una carcasa incompleta deben protegerse contra las emisiones CEM por parte de profesionales de acuerdo con las disposiciones locales sobre la CEM.

FI - Suomi

Turvallisuus

Lue nämä turvallisuusohjeet ennen kameran käyttöä. Noudata varoituksia joka hetki. Käytä kameraa ainoastaan kohdassa [Intended use](#) sivulla 45 kuvatulla tavalla.



HUOMIO

Palovammojen vaara

Käytössä olevan kameran saavuttamat lämpötilatasot voivat aiheuttaa palovammoja.



HUOMIO

Putoavien kameroiden tai linssien aiheuttamat vammat

Putoava kamera tai linssi voi aiheuttaa vammoja.



HUOMIO

Linssien kiinnikkeiden terävien reunojen aiheuttamien viiltovammojen vaara

Linssin kiinnikkeiden kierteiden reunat voivat olla teräviä.

Käyttötarkoitus

Allied Vision -tuotteen käyttötarkoitus on integrointi kuvajärjestelmiin ammattilaisten toimesta. Kaikki Allied Vision -tuotteet myydään B2B-ympäristössä.

Kamerat, joissa ei ole suljettuja koteloita

Ammattilaisten on suojattava kamerat, joissa ei ole koteloa tai joiden kotelo on epätäydellinen, EMC-päästöiltä paikallisten EMC-määräysten mukaisesti.

FR - Français

Sécurité

Veillez lire ces consignes de sécurité avant d'utiliser la caméra. Respectez continuellement les avertissements. Utilisez la caméra uniquement comme indiqué sous [Intended use](#), page 45.



ATTENTION

Risque de brûlures

Une caméra en service peut atteindre des niveaux de température susceptibles d'entraîner des brûlures.



ATTENTION

Blessures en cas de chute de caméras ou d'objectifs

La chute d'une caméra ou d'un objectif peut entraîner des blessures.



ATTENTION

Risque de coupures sur les bords tranchants des montures d'objectif

Les filetages des montures d'objectif peuvent présenter des bords tranchants.

Utilisation prévue

L'utilisation prévue du produit Allied Vision est son intégration dans des systèmes de vision par le soin de professionnels. Tout produit Allied Vision est vendu dans un cadre B2B.

Caméras sans boîtier fermé

Les caméras sans boîtier fermé ou à boîtier incomplet doivent être blindées contre les émissions CEM par le soin de professionnels conformément aux dispositions CEM locales.

עברית - HE

בטיחות

לפני השימוש במצלמה, עליך לקרוא את הוראות הביטחון האלו. עליך לממש הוראות ביטחון אלו תמיד. השימוש במצלמה הוא רק לפי מה שכתוב ב"כוונת השימוש" (Intended use) בעמוד 45.

זהירות

סכנת כוויה

בזמן הפערת המצלמה עלולות מפרטורות גבוהות לעלות, שיכולות לגרום לכוויות.



זהירות

פציעה מנפילת מצלמות או עדשות

מצלמה או עדשה שנופלות עלולות לגרום לפציעה.



זהירות

סכנה להחתרך מתברג חד של העדשה

תברג תושבת העדשה עלול להיות חד עד כדי פציעה.



שימוש מיועד

מוצרי AlliedVision מיועדים לשילוב במערכות ממוחשבת לעיבוד צילומים ע"י אנשי מקצוע. כל מוצרי AlliedVision נמכרים לשימוש בסביבת B2B.

IT - Italiano

Sicurezza

Leggere queste istruzioni per la sicurezza prima di utilizzare la telecamera. Osservare sempre tutte le avvertenze. Utilizzare la telecamera come descritto alla sezione [Intended use](#) a pagina 45.



ATTENZIONE

Pericolo di ustioni

Durante il funzionamento una telecamera può raggiungere temperature elevate che possono essere causa di ustioni.



ATTENZIONE

Lesioni dovute alla caduta di telecamere o lenti

La caduta di una telecamera o di una lente può causare delle lesioni.



ATTENZIONE

Pericolo di tagliarsi sui bordi affilati degli attacchi della lente

I bordi della filettatura dell'attacco della lente possono essere affilati.

Uso previsto

Il prodotto Allied Vision è concepito per essere integrato in sistemi di monitoraggio in campo professionale. Tutti i prodotti Allied Vision sono venduti in uno scenario B2B.

Telecamere senza custodia chiusa

Le telecamere senza custodia o con una custodia incompleta devono essere protette dalle emissioni elettromagnetiche in ambienti professionali in conformità con le norme CEM nazionali.

JA – 日本語

安全性

本カメラを使用する前に、この安全の手引きをお読みください。常に、警告事項を守ってください。必ず、[Intended use](#) 45 ページの通りに、本カメラを使用してください。



注意

やけどの危険性

作動中のカメラは、やけどを引き起こす温度まで熱くなる恐れがあります。



注意

カメラまたはレンズの落下によるけが

カメラまたはレンズが落下すると、けがをする恐れがあります。



注意

レンズマウントの鋭利な端部で切り傷の危険性

レンズマウントのギザギザの部分が鋭利である可能性があります。

用途

Allied Vision製品は、専門家が視覚装置に統合することを意図したものです。すべてのAllied Vision製品は、企業間取り引き用に販売されています。

ハウジングで閉じられていないカメラ

ハウジングのないカメラまたはハウジングが不完全なカメラは、現地の電磁両立性 (EMC) 規定に従い、専門家によって、EMC エミッションから保護される必要があります。

NL - Nederlands

Veiligheid

Lees deze veiligheidsinstructies voordat u de camera gaat gebruiken. Neem deze waarschuwingen altijd in acht. Gebruik de camera uitsluitend, zoals aangegeven in het [Intended use](#) op pagina 45.



VOORZICHTIG

Risico van verbranding

Een camera die gebruikt wordt, kan temperatuurwaarden bereiken die brandwonden kunnen veroorzaken.



VOORZICHTIG

Letsel door vallende camera's of lenzen

Een vallende camera of lens kan letsel veroorzaken.



VOORZICHTIG

Risico van snijwonden door scherpe randen van lensbevestigingen

Het schroefdraad van de lensbevestiging kan scherpe randen hebben.

Beoogd gebruik

Het beoogde gebruik van het Allied Vision-product is de integratie in optische systemen door professionals. Alle Allied Vision-producten worden verkocht in de B2B-markt.

Camera's zonder gesloten behuizing

Camera's zonder behuizing of met een onvolledige behuizing moeten door professionals worden beschermd tegen EMC-straling door EMC-beschermingen ter plaatse.

NO - Norsk

Sikkerhet

Les disse sikkerhetsinstruksene før du bruker kameraet. Følg advarslene til en hver tid. Bruk kun kameraet i samsvar med [Intended use](#) på side 45.



FORSIKTIG

Risiko for brannskader

Et kamera i bruk kan nå temperaturnivåer som kan forårsake brannskader.



FORSIKTIG

Skade ved fallende kameraer eller linser

Et fallende kamera eller en fallende linse kan forårsake skade.



FORSIKTIG

Risiko for kutt fra skarpe kanter på linsefester

Sporene på linsefestet kan ha skarpe kanter.

Tiltenkt bruk

Den tiltenkte bruken av Allied Vision-produktet er integrering i visjonssystemer av profesjonelle. Alle Allied Vision-produkter selges i en forretning til forretning-situasjon.

Kameraer uten lukkede kamerahus

Kameraer uten kamerahus eller med ufullstendige kamerahus må beskyttes mot EMC-utslipp av fagfolk i henhold til lokale EMC-bestemmelser.

SV - Svenska

Säkerhet

Läs igenom säkerhetsinstruktionerna innan du använder kameran. Var hela tiden särskilt uppmärksam på varningarna. Använd enbart kameran på det sätt som anges i [Intended use](#) på sida 45.



VARNING

Risk för brännskada

En kamera i drift kan komma upp i temperaturer som kan orsaka brännskador.



VARNING

Risk för skador från fallande kameror eller objektiv

Fallande kameror eller objektiv kan förorsaka skador.



VARNING

Risk för skärsår från vassa kanter på objektivfattningar

Objektivets gängor kan ha vassa kanter.

Avsedd användning

Den avsedda användningen av Allied Vision-produkter är integrering i visionssystem av fackmän. Samtliga Allied Vision-produkter säljs i en B2B-miljö.

Kameror utan slutna kamerahus

Kameror utan eller med ofullständiga kamerahus måste skyddas mot elektromagnetiska emissioner av fackmän enligt lokala bestämmelser för elektromagnetiska emissioner.

ZH - 简体中文版

安全需知

使用本相机前，请阅读本安全说明书。请务必遵守相关警告和 [Intended use](#) 于第 45 页。



注意事项

烫伤风险

相机操作过程中温度可能上升并导致烫伤风险。



注意事项

相机或者镜头跌落造成伤害

相机或者镜头可能会跌落并造成伤害。



注意事项

镜头接口的锐利边缘划伤风险

镜头接口螺纹边缘可能较为锐利。

预期用途

Allied Vision 产品的预期用途是由专业人士整合到视觉系统中。所有 Allied Vision 的产品均通过 B2B 渠道销售。

无封闭式外壳相机

使用不带外壳或外壳不完整的相机时，必须由专业人员根据当地的 EMC 规定，对其进行 EMC 屏蔽。

Contact us

Website, email

General

www.alliedvision.com/en/contact
info@alliedvision.com

Distribution partners

www.alliedvision.com/en/avt-locations/avt-distributors

Support

www.alliedvision.com/en/support
www.alliedvision.com/en/about-us/contact-us/technical-support-repair/-/rma

Offices

**Europe, Middle East, and Africa
(Headquarters)**

Allied Vision Technologies GmbH
Taschenweg 2a
07646 Stadtroda, Germany
T// +49 36428 677-0 (Reception)
T// +49 36428 677-230 (Sales)
F// +49 36428 677-28

Asia-Pacific**China**

Allied Vision Technologies
(Shanghai) Co., Ltd.
2-2109 Hongwell Int. Plaza
1602# ZhongShanXi Road
Shanghai 200235, China
T// +86 21 64861133

Singapore

Allied Vision Technologies Asia Pte. Ltd
82 Playfair Rd, #07-01 D'Lithium
Singapore 368001
T// +65 6634 9027

North, Central, and South America**Canada**

Allied Vision Technologies Canada Inc.
300 – 4621 Canada Way
Burnaby, BC V5G 4X8, Canada
T// +1 604 875 8855

USA

Allied Vision Technologies, Inc.
102 Pickering Way- Suite 502
Exton, PA 19341, USA
Toll-free// +1-877-USA-1394
T// +1 978 225 2030

Contents

Read before use	2
EN - English	2
DA - Dansk.....	3
DE - Deutsch.....	4
ES - Español.....	5
FI - Suomi	6
FR - Français.....	7
HE - עברית.....	8
IT - Italiano	9
JA - 日本語	10
NL - Nederlands	11
NO - Norsk.....	12
SV - Svenska	13
ZH - 简体中文版	14
Contact us	15
Website, email	15
Offices	15
Introduction	25
Document history	25
Manual overview	37
Conventions used in this manual	39
Styles.....	39
More information	40
Before operation	41
Stingray cameras	42
Compliance, safety, and intended use	43
Compliance notifications	43
For customers in China and Europe.....	43
For customers in the USA.....	43
FCC Class B digital device	43
United States of America: Supplier Declaration of Conformity	43
Party issuing Supplier's Declaration of Conformity	44
Responsible Party - U.S. Contact Information	44
For customers in Canada	44
Pour utilisateurs au Canada	44
Board level models.....	44
Avoid electromagnetic interferences	44
Intended use	45
Copyright and trademarks.....	45

Your safety	45
Handling lens mounts.....	45
Handling hot cameras	45
Providing optimum heat dissipation	46
Camera mounting.....	46
Avoiding material damage.....	47
Electronics maintenance	47
Cable connections	47
Powering cameras.....	47
No hot plugging.....	47
Avoiding electrostatic discharge (ESD)	47
Maximum inrush current	48
Suitable accessories	48
Cleaning cameras	48
Warranty note	48
FireWire.....	49
Overview	49
Definition	49
IEEE 1394 standards	49
Why use FireWire?	50
FireWire in detail	50
Serial bus	50
FireWire connection capabilities.....	51
Capabilities of IEEE 1394a (FireWire 400)	52
IIDC V1.3 camera control standards	52
Capabilities of IEEE 1394b (FireWire 800)	52
IIDC V1.31 camera control standards.....	52
Compatibility between IEEE 1394a and IEEE 1394b.....	53
Compatibility example	53
Image transfer via IEEE 1394a and IEEE 1394b	54
IEEE 1394b bandwidths.....	55
Requirements for PC and IEEE 1394b.....	55
Example 1: IEEE 1394b bandwidth of Stingray cameras	56
Example 2: More than one Stingray camera at full speed	56
FireWire Plug & play capabilities.....	56
FireWire hot-plug and screw-lock precautions.....	57
Operating system support.....	58
Specifications.....	59
Absolute quantum efficiency	60
Spectral response plots	60
Stingray F-033B/F-033C.....	61
Absolute QE	63
Spectral response	63
Stingray F-046B/F-046C.....	64
Absolute QE	66
Spectral response	66

Stingray F-080B/F-080C.....	67
Absolute QE	69
Spectral response	69
Stingray F-125B/F-125C.....	70
Absolute QE	72
Spectral response	72
Stingray F-145B/F-145C.....	73
Absolute QE	75
Spectral response	75
Stingray F-146B/F-146C.....	76
Absolute QE	78
Spectral response	78
Stingray F-201B/F-201C.....	79
Absolute QE	81
Spectral response	81
Stingray F-504B/F-504C.....	82
Absolute QE	84
Spectral response	84
Camera dimensions	85
Serial numbers for starting new front flange	85
Stingray standard housing (2 x IEEE 1394b copper)	86
Tripod adapter	87
Stingray W90 (2 x IEEE 1394b copper).....	88
Stingray W90 S90 (2 x IEEE 1394b copper)	89
Stingray W270 (2 x IEEE 1394b copper).....	90
Stingray W270 S90 (2 x IEEE 1394b copper).....	91
Cross section: CS-Mount	92
Cross section: C-Mount	93
Adjustment of C-Mount and CS-Mount	93
Stingray board level: dimensions	94
Stingray board level: CS-Mount.....	95
Stingray board level: C-Mount	96
Filter and lenses	97
IR cut filter: spectral transmission.....	97
Camera lenses.....	98
Stingray F-080, F-125	98
Stingray F-033, F-046, F-146	98
Stingray F-201.....	99
Stingray F-145, F-504	99
Camera interfaces	100
IEEE 1394b port pin assignment.....	100
Board level camera: IEEE 1394b port pin assignment.....	101
Camera I/O connections.....	102
Board level camera: I/O pin assignment.....	104

Status LEDs.....	105
Normal conditions	106
Error conditions.....	106
Control data signals	107
Inputs	107
Triggers.....	107
Input/output pin control	108
IO_INP_CTRL 1-2	108
Trigger delay.....	109
Outputs.....	111
IO_OUTP_CTRL 1-4.....	112
Output control.....	113
Output modes	114
Pulse-width modulation (Stingray housing and Stingray board level models)	116
PWM: minimal and maximal periods and frequencies	117
PWM: Examples in practice	118
Pixel data.....	119
<YUV8 (4:2:2) format>	120
<YUV8 (4:1:1) format>	120
<Y (Mono8/Raw8) format>	121
<Y (Mono16/Raw16) format>.....	121
<Y (Mono12/Raw12) format>.....	122
<RGB8 format>.....	122
<Y(Mono8/Raw8), RGB8>	123
<YUV8>	123
<Y(Mono16)>.....	124
<Y(Mono12)>.....	124
Description of the data path	125
Block diagrams of the cameras	125
Monochrome cameras	125
Color cameras.....	126
White balance	126
One-push white balance	129
Auto white balance (AWB)	130
Auto shutter.....	132
Auto gain.....	133
Manual gain	136
Brightness (black level or offset)	137
Horizontal mirror function	138
Shading correction.....	139
Building shading image in Format_7 modes.....	139
First example	139
Second example	139
How to store shading image	140
Automatic generation of correction data	141
Requirements	141
Algorithm.....	141

Loading a shading image out of the camera.....	144
Loading a shading image into the camera.....	145
Look-up table (LUT) and gamma function	146
Loading an LUT into the camera	147
Defect pixel correction	148
Building defect pixel correction image in Format_7 modes	148
First example	149
Second example	149
Flow diagram of defect pixel correction	149
Building defect pixel data	150
Grab an image with defect pixel data.....	150
Calculate defect pixel coordinates.....	150
Reset values (resolution, shutter, gain, brightness).....	151
Activate/deactivate defect pixel correction	151
Store defect pixel data non-volatile.....	152
Load non-volatile stored defect pixel data	152
Send defect pixel data to the host.....	152
Receive defect pixel data from the host.....	152
DPC data: storing mechanism	153
Binning (only Stingray monochrome models and F-201C/504C)	153
2 x / 4 x / 8 x binning (F-201C only 2 x vertical binning).....	153
Vertical binning.....	154
Horizontal binning (F-201C only 2 x horizontal binning).....	156
2 x full binning/4 x full binning/8 x full binning (F-201C only 2 x full binning).....	157
Sub-sampling (Stingray monochrome and color models)	158
What is sub-sampling?	158
Which Stingray models have sub-sampling?	158
Description of sub-sampling.....	158
Binning and sub-sampling access	163
Quick parameter change timing modes.....	165
Stingray timing modes.....	165
Standard Parameter Update Timing.....	166
Quick Format Change Mode (QFCM)	166
How to transfer parameters to the camera.....	167
Encapsulated Update (begin/end).....	167
Parameter-List Update.....	168
Standard Update (IIDC)	169
Packed 12-Bit Mode	170
High SNR mode (High Signal Noise Ratio)	171
Frame memory and deferred image transport.....	172
Deferred image transport	172
HoldImg mode	173
FastCapture mode	175
Color interpolation (BAYER demosaicing)	175
Sharpness.....	177
Hue and saturation	178
Color correction.....	179
Why color correction?	179

Color correction in Allied Vision cameras	179
Color correction: formula	179
GretagMacbeth ColorChecker	179
Changing color correction coefficients	179
Switch color correction on/off	180
Color conversion (RGB to YUV)	181
Bulk Trigger	181
Level Trigger	181
Serial interface	181
To read data:	185
To write data:	185
Controlling image capture	186
Trigger modes	186
Bulk trigger (Trigger_Mode_15)	187
Trigger delay	190
Trigger delay advanced register	192
Software trigger	192
Debounce	193
Debounce time	193
Exposure time (shutter) and offset	194
Exposure time offset, minimum exposure time	195
Extended shutter	196
One-shot	197
One-shot command on the bus to start exposure	198
End of exposure to first packet on the bus	198
Multi-shot	200
ISO_Enable / free-run	200
Asynchronous broadcast	200
Jitter at start of exposure	202
Sequence mode	203
How is sequence mode implemented?	205
Setup mode	206
Sequence step mode	206
SeqMode description	206
Sequence repeat counter	207
Manual stepping & reset	207
Which sequence mode features are available?	209
Setup mode	209
I/O controlled sequence stepping mode	209
I/O controlled sequence pointer reset	210
I/O controlled sequence stepping mode	210
Points to pay attention to when working with a sequence	210
Changing the parameters within a sequence	212
Points to pay attention to when changing the parameters	212
Secure image signature (SIS): definition and scenarios	212
SIS: Definition	213
SIS: Scenarios	213

Video formats, modes and bandwidth	215
Stingray F-033B/F-033C (including board level variants)	216
Stingray F-046B/F-046C (including board level variants)	218
Stingray F-080B/F-080C (including board level variants)	220
Stingray F-125B/F-125C (including board level variants)	222
Stingray F-145B/F-145C (including board level variants)	224
Stingray F-146B/F-146C (including board level variants)	226
Stingray F-201B/F-201C (including board level variants)	228
Stingray F-504B/F-504C (including board level variants)	231
Area of interest (AOI).....	233
Autofunction AOI.....	235
Frame rates.....	236
Frame rates Format_7.....	240
Stingray F-033B/F-033C (incl. board level): AOI frame rates	241
Stingray F-046B/F-046C (incl. board level): AOI frame rates	242
Stingray F-080B/F-080C (incl. board level): AOI frame rates	243
Stingray F-125B/F-125C (incl. board level): AOI frame rates	244
Stingray F-145B/F-145C (incl. board level): AOI frame rates	245
Stingray F-146B/F-146C (incl. board level): AOI frame rates	246
Stingray F-201B/F-201C (incl. board level): AOI frame rates	247
Stingray F-504B/F-504C (incl. board level): AOI frame rates	248
How does bandwidth affect the frame rate?	249
Example formula for the monochrome camera.....	250
Test images	251
Loading test images.....	251
Test images for monochrome cameras	251
Test images for color cameras	252
YUV4:2:2 mode	252
Mono8 (raw data)	252
Configuration of the camera	253
Camera_Status_Register	253
Example	254
Sample program	255
Example FireGrab.....	255
Example FireStack API.....	256
Configuration ROM.....	257
Implemented registers (IIDC V1.31).....	260
Camera initialize register.....	260
Inquiry register for video format	260
Inquiry register for video mode	261
Inquiry register for video frame rate and base address	262
Inquiry register for basic function.....	271
Inquiry register for feature presence.....	272
Inquiry register for feature elements	274
Status and control registers for camera	277

Inquiry register for absolute value CSR offset address.....	278
Status and control register for one-push.....	279
Feature control error status register	282
Video mode control and status registers for Format_7	282
Quadlet offset Format_7 Mode_0.....	282
Quadlet offset Format_7 Mode_1.....	282
Format_7 control and status register (CSR)	283
Temperature register	284
Advanced features (Allied Vision-specific)	285
Advanced registers summary.....	285
Extended version information register	288
Advanced feature inquiry.....	289
Camera status.....	292
Maximum resolution	293
Time base.....	293
Extended shutter	295
Permanent Data Storage.....	295
Reading from the data storage	296
Writing to an empty data storage	297
Append data to the data storage.....	297
Erasing data on the camera	298
Test images.....	298
Look-up tables (LUT)	300
Loading a LUT into the camera	301
Shading correction	302
Reading or writing shading image from/into the camera.....	303
Automatic generation of a shading image	304
Memory channel error codes	304
Deferred image transport	305
Frame information	305
Defect pixel correction.....	306
Input/output pin control.....	308
Delayed Integration Enable (IntEna).....	308
Auto shutter control.....	309
Auto gain control.....	311
Autofunction AOI.....	312
Color correction.....	313
Trigger delay.....	314
Mirror image.....	314
Soft reset	315
High SNR mode (High Signal Noise Ratio).....	316
Maximum ISO packet size	317
Quick parameter change timing modes.....	319
Standard Parameter Update Timing.....	319
Quick Format Change Mode	319
Automatic reset of the UpdActive flag	320
Parameter-List Update	321
Format_7 mode mapping.....	322
Example	323

Low noise binning mode (2 x and 4 x binning)	323
Secure image signature (SIS).....	324
Advanced register: SIS.....	324
Examples: cycle time	325
Advanced register: frame counter	327
Advanced register: trigger counter.....	328
Where to find cycle time, frame counter and trigger counter in the image	328
Where to find all SIS values in the image	329
Software feature control (disable LEDs)	330
Disable LEDs	330
User profiles	331
Error codes	332
Reset of error codes.....	332
Stored settings	333
Pulse-width modulation (PWM): Stingray housing and board level cameras.....	334
Gpdata_BUFFER.....	334
Little endian vs. big endian byte order	334
Firmware update	335
Extended version number (microcontroller and FPGA).....	335
Appendix.....	336
Sensor position accuracy of Stingray cameras.....	336
Index.....	337

Introduction

This Stingray Technical Manual describes in depth the technical specifications, dimensions, all camera features (IIDC standard and Allied Vision smart features) and their registers, trigger features, all video and color formats, bandwidth, and frame rate calculation.

For information on hardware installation, safety warnings, and pin assignments on I/O connectors and IEEE 1394b connectors read the 1394 Installation Manual.

Note Please read through this manual carefully.



We assume that you have read already the 1394 Installation Manual (see: www.alliedvision.com/en/support/technical-documentation) and that you have installed the hardware and software on your PC or laptop (FireWire card, cables).

Document history

Version	Date	Remarks
V2.0.0	2008-Mar-31	New Manual - Release status
V2.1.0	2008-May-23	<p>New CAD drawings due to new flange in Chapter Camera dimensions on page 85</p> <p>Added Appendix: Chapter Appendix on page 336</p> <p>Added direct fiber technology in Chapter Stingray cameras on page 42</p> <p>Added fiber cameras (1 x copper, 1 x GOF) and fiber power consumption in all tables in Chapter Specifications on page 59</p> <p>Added Chapter Pulse-width modulation (Stingray housing and Stingray board level models) on page 116</p> <p>Added Chapter Horizontal mirror function on page 138</p> <p>Added Chapter Shading correction on page 139</p>

Table 1: Document history

Version	Date	Remarks
V2.1.0 [continued]	2008-May-23 [continued]	<p>Added 4 x and 8 x binning in Chapter Binning (only Stingray monochrome models and F-201C/504C) on page 153</p> <p>Added 2 out of 8 sub-sampling in Chapter Sub-sampling (Stingray monochrome and color models) on page 158</p> <p>Changed Table 76 on page 164</p> <p>Added fiber models in Table 56 on page 159</p> <p>Added Chapter Temperature register on page 284</p> <p>Added Shading control registers (0xF1000250, 0xF1000254, 0xF1000258) in Table 126 on page 285</p> <p>Added Mirror image register (0xF1000410) in Table 126 on page 285</p> <p>Added board level variants in Table 128 on page 289</p> <p>Added Shading and Mirror image in Table 129 on page 290</p> <p>Added Chapter Shading correction on page 302</p> <p>Added Chapter Mirror image on page 314</p> <p>Added Appendix Chapter Appendix on page 336</p> <p>Added 0x09 PWM in Table 30 on page 114</p> <p>Added Chapter Board level camera: IEEE 1394b port pin assignment on page 101</p> <p>Added Chapter Board level camera: I/O pin assignment on page 104</p> <p>Added PWM feature in Chapter IO_OUTP_CTRL 1-4 on page 112</p> <p>Added Table on page 116</p> <p>Added PWM feature in Table 30 on page 114</p> <p>Added board level in Table on page 215</p> <p>Added board level (BL) in Table 128 on page 289</p> <p>Added PWM in Table 129 on page 290</p> <p>Changed resolutions of Format_7 modes in Chapter Video formats, modes and bandwidth on page 215</p> <p>Corrected RGB8 frame rates in Format_7 Mode_0 in Chapter Video formats, modes and bandwidth on page 215</p>

Table 1: Document history (continued)

Version	Date	Remarks
V2.1.0 [continued]	2008-May-23 [continued]	<p>Added frame rates for binning and sub-sampling modes in Chapter Video formats, modes and bandwidth on page 215</p> <p>Added Chapter Appendix on page 336</p> <p>Changed provisions directive to 2004/108/EG in Chapter Conformity on page 28</p>
V2.2.0	2008-Aug-15	<p>Corrected Hirose connector in CAD drawings in Chapter Camera dimensions on page 85</p> <p>Added cross-reference from upload LUT to GPDATA_BUFFER in Chapter Loading a shading image into the camera on page 145</p> <p>Added cross-reference from upload/download shading image to GPDATA_BUFFER in:</p> <ul style="list-style-type: none"> – Chapter Loading a shading image out of the camera on page 144 – Chapter Loading a shading image into the camera on page 145 <p>Added little endian vs. big endian byte order in Chapter GPDATA_BUFFER on page 334</p> <p>Added detailed cross-reference in Chapter Camera I/O connections on page 102</p> <p>Added detailed level values of I/Os in Chapter Camera I/O connections on page 102</p> <p>Rounded shutter speeds in Chapter Specifications on page 59</p> <p>Rounded offsets in Chapter Exposure time (shutter) and offset on page 194 and in Table 88 on page 199</p> <p>Added new image of Stingray camera with two screws on either side of the cameras for fixing the front flange:</p> <ul style="list-style-type: none"> – See title page <p>New Stingray photo on title page (with new screws on either side of camera)</p> <p>New photo of LED positions in Table 37 on page 105</p>
V2.3.0	2008-Sep-12	<p>New Stingray board level CAD drawing with new Molex 1.25 mm Pitch PicoBlade Wire-to-Board Header (53047-1310) and new cable lengths in Table 34 on page 101 and in Table 36 on page 104</p>
V2.4.0	2008-Sep-30	<p>New Stingray board level CAD drawing with new Molex 1.25 mm Pitch PicoBlade Wire-to-Board Header (53047-1310) in:</p> <ul style="list-style-type: none"> – Table 29 on page 94 – Table 30 on page 95 – Table 31 on page 96

Table 1: Document history (continued)

Version	Date	Remarks
V3.0.0	2008-Oct-08	<p>New Stingray board level CAD drawing with name of screws M2x14 ISO7045-A2 (2x):</p> <ul style="list-style-type: none"> - Table 30 on page 95 - Table 31 on page 96 <p>New Stingray F-125B/C: Read information in the following sections:</p> <ul style="list-style-type: none"> • Table 10 on page 46 • Table 56 on page 159 • Table 67 on page 195 • Table on page 195 • Table 88 on page 199 • Table 72 on page 202 • Table 83 on page 222 • Table 84 on page 223 • Table 128 on page 289 <p>For Stingray F-125B/C output switching times (tp and minimum shutter) see FireWire Hardware Installation Guide, subsection Stingray delay</p>
V4.0.0	2008-Oct-21	<p>New Stingray F-504B/C: Read information in the following sections:</p> <ul style="list-style-type: none"> • Table 14 on page 54 • Table 56 on page 159 • Table 67 on page 195 • Table 67 on page 195 • Table 88 on page 199 • Table 72 on page 202 • Table 91 on page 231 • Table 92 on page 232 • Table 128 on page 289 <p>For Stingray F-504B/C output switching times (tp and minimum shutter) see FireWire Hardware Installation Guide, subsection Stingray delay</p>

Table 1: Document history (continued)

Version	Date	Remarks
V4.1.0	2009-Jan-28	<p>All advanced registers in 8-digit format beginning with 0xF1to in Chapter Advanced features (Allied Vision-specific) on page 285 and in Chapter Parameter-List Update on page 321</p> <p>New CAD drawings (hexagon socket head cap screw ISO 4762):</p> <ul style="list-style-type: none"> • Table 29 on page 94 • Table 30 on page 95 • Table 31 on page 96 • Table 34 on page 101 • Table 36 on page 104 <p>SEQUENCE_RESET register moved to SEQUENCE_STEP register (0xF100228) in Table on page 205 and in Table on page 285</p> <p>Corrected CAD drawing in Table 24 on page 89</p> <p>Revised Chapter White balance on page 126ff</p> <p>Memory size (Internal FIFO memory) of Stingray F-125 is 12 frames in Table 10 on page 46 and in Table 56 on page 159</p> <p>Revised Table 100 on page 244</p> <p>Corrected black level increments in Chapter Brightness (black level or offset) on page 137</p> <p>New AOI frame rates of Stingray F-504 in Chapter Stingray F-504 frame rate as a function of AOI height [width=2452] on page 248</p> <p>New Stingray F-125C RGB8 modes in Table 83 on page 222</p> <p>New Stingray F-504C RGB8 modes in Table 91 on page 231</p>

Table 1: Document history (continued)

Version	Date	Remarks
V4.2.0	2009-May-28	<p>Calculated effective chip size for all sensors (with resolution of Format_7 Mode_0) in Chapter Specifications on page 59</p> <p>SIS feature: standardized terminology, added examples in Chapter Secure image signature (SIS): definition and scenarios on page 212</p> <p>Stingray cameras do not support storing shading image data into non-volatile memory, see Table 138 on page 302 (OXF1000250 bit 8 to 10)</p> <p>Corrected drawing in Table 107 on page 308</p> <p>In SIS chapter: added cycle time examples: Chapter Examples: cycle time on page 325</p> <p>Stingray update round (SUR):</p> <ul style="list-style-type: none"> • Only glass optical fiber (GOF) models: new LED signals (asynchronous traffic and signal detect) in Table 21 on page 106 • Stingray F-504 cameras are also available with 64 MB internal FIFO memory (instead of 32 MB): <ul style="list-style-type: none"> – Table 14 on page 54 and – Table 56 on page 159 • All Stingray models: added defect pixel correction: <ul style="list-style-type: none"> – Chapter Defect pixel correction on page 148 – Table 142 on page 306 • All Stingray models: added low noise binning mode: <ul style="list-style-type: none"> – Table 158 on page 323 • All Stingray models: added software trigger: <ul style="list-style-type: none"> – In inquiry register 530h on page 275 added: Value_Read_Inq [7], Trigger_Source0_Inq [8] and Software_Trigger_Inq [15] – In inquiry register 62Ch on page 277 added: Software_Trigger • All Stingray models: added disable LEDs function: <ul style="list-style-type: none"> – Chapter Software feature control (disable LEDs) on page 330 • All Stingray GOF models: added two new LED signals <ul style="list-style-type: none"> – Only GOF: asynchronous traffic on page 93 – Only GOF: GOF signal detect on page 93

Table 1: Document history (continued)

Version	Date	Remarks
V4.2.0 [continued]	2009-May-28 [continued]	<p>Stingray update round (SUR):</p> <ul style="list-style-type: none"> All Stingray models: added debounce feature: <ul style="list-style-type: none"> Advanced register summary 0xF1000840 on page 287 Advanced register summary 0xF1000850 on page 287 Advanced register summary 0xF1000860 on page 287 Advanced register summary 0xF1000870 on page 287 Chapter Debounce on page 193 Table 66 on page 194 WaitingForTrigger signal for outputs <ul style="list-style-type: none"> Table 28 on page 111 Output mode: trigger ID 0x0A on page 114 Table 40 on page 115
V4.3.0	2009-Sep-15	<p>Minor corrections:</p> <ul style="list-style-type: none"> Notice about connection between temperature at sensor and temperature at camera housing on page 284 Corrected registers for IO_OUTP_PWM2/3/4 in Table 31 on page 116 and in Table 126 on page 285 Revised Chapter Conformity on page 28 New drawings to show maximum protrusion: Table 27 on page 92 and Table 28 on page 93 New values for maximum protrusion: tables in Chapter Camera dimensions on page 85 Corrected addresses of debounce registers: <ul style="list-style-type: none"> Advanced register summary 0xF1000840 on page 287 Advanced register summary 0xF1000850 on page 287 Advanced register summary 0xF1000860 on page 287 Advanced register summary 0xF1000870 on page 287 Table 66 on page 194 Stingray cameras with serial numbers S/N greater 09/17-285831532 have a heat sink and thus the mass of the camera increases from 92 g up to 108 g: see Chapter Specifications on page 59 <p>2x/4x/8x binning:</p> <ul style="list-style-type: none"> Stingray F-504C has now also the usual 2x/4x/8x binning (no color binning): see Chapter Binning (only Stingray monochrome models and F-201C/504C) on page 153 and Chapter Binning and sub-sampling access on page 163 and Table 14 on page 54

Table 1: Document history (continued)

Version	Date	Remarks
V4.3.0 [continued]	2009-Sep-15 [continued]	<p>New front flange:</p> <ul style="list-style-type: none"> Title page: new Stingray photo New CAD drawings: <ul style="list-style-type: none"> All CAD drawings in Chapter Camera dimensions on page 85 Cross section drawings in Table 27 on page 92 and Table 28 on page 93. Adjustments by means of the adjustment spacer(s) have to be done in the Allied Vision factory. Contact Allied Vision support. Table 34 on page 101 Table 36 on page 104
V4.4.0	2010-Jul-12	<p>Improvements:</p> <ul style="list-style-type: none"> HSNR description, see Chapter High SNR mode (High Signal Noise Ratio) on page 316 <p>New Stingray front flange:</p> <ul style="list-style-type: none"> Serial numbers for Stingray camera models starting new front flange: Chapter Serial numbers for starting new front flange on page 85 <p>Corrections:</p> <ul style="list-style-type: none"> Corrected Note on BitsPerValue, see Table on page 301 <p>New Stingray Compact:</p> <ul style="list-style-type: none"> Chapter Cross section: CS-Mount on page 92 <p>New storage temperature:</p> <ul style="list-style-type: none"> 70 °C, see Chapter Specifications on page 59 <p>New links to new Allied Vision website:</p> <ul style="list-style-type: none"> Chapter Contact us on page 15 and many others <p>New measured sensitivity curves:</p> <ul style="list-style-type: none"> chapter Absolute quantum efficiency on page 56 <p>Added RGB8 in fixed formats:</p> <ul style="list-style-type: none"> Table 77 on page 216 Table 79 on page 218 Table 85 on page 224 <p>Added Full support Windows 7 for IEEE 1394a/IEEE 1394b:</p> <ul style="list-style-type: none"> Table 6 on page 58 <p>Corrected trigger diagram:</p> <ul style="list-style-type: none"> Table 40 on page 115

Table 1: Document history (continued)

Version	Date	Remarks
V4.4.1	2011-Jan-07	<ul style="list-style-type: none"> • Minor corrections • Converted FrameMaker files from FM7 to FM9 • Added required minimum number of GrabCount value (2) for HIGH_SNR ON in Table 151 on page 316 • Added info that for 8-bit video modes, the internal HSNR calculations are done with 14-bit: Chapter High SNR mode (High Signal Noise Ratio) on page 171 • Changed tripod drawing: added dimensions of three big holes (M6 and UNC 1/4-20) in Table 22 on page 87 • Added Windows 7 support and revised Windows XP/Windows Vista in Chapter FireWire and operating systems on page 58
V4.4.2	2011-Apr-15	<ul style="list-style-type: none"> • Added sensitivity curves for Stingray F-125B/F-125C: see Table 11 on page 60 and see Table 12 on page 60 <p>C-/CS-Mount no more adjustable, for modifications contact Allied Vision support and send camera to Allied Vision:</p> <ul style="list-style-type: none"> • See Chapter Specifications on page 59 • See Chapter Adjustment of C-Mount and CS-Mount on page 93 <p>Stingray firmware update round:</p> <ul style="list-style-type: none"> • Defect pixel correction: you do not need to set value for brightness to maximum any more: see Table 59 on page 149 and Chapter Grab an image with defect pixel data on page 150 • Besides in Mono8 mode defect pixel correction is also possible in Raw8 mode: see note in Chapter Building defect pixel data on page 150 • Revised Chapter Defect pixel correction on page 148 • Image is shot internally during calculating a mean value: see note in Chapter Calculate defect pixel coordinates on page 150 • Activate HSNR mode to improve defect pixel correction: see note in Chapter Building defect pixel data on page 150

Table 1: Document history (continued)

Version	Date	Remarks
V4.4.2 [continued]	2011-Apr-15 [continued]	<p>Stingray firmware update round:</p> <ul style="list-style-type: none"> Added descriptions for defect pixel correction in F7 modes: see Chapter Building defect pixel correction image in Format_7 modes on page 148 Shading correction in Format_7 mode 0 (Mono8) is only available up to S400: see note in Chapter Building shading image in Format_7 modes on page 139 <p>Some smaller corrections:</p> <ul style="list-style-type: none"> At register 0xF1000200 changed width and height: see Table 131 on page 293 YUV8: deleted description of data type <i>straight binary</i>: Table 43 on page 123 Y (Mono8/Raw8) are Allied Vision own formats: see Table 36 on page 121
V4.4.3	2012-Mar-15	<p>Some smaller corrections:</p> <ul style="list-style-type: none"> User sets changed: LUT and on/off bit can be stored in user settings: see Chapter Stored settings on page 333 Stingray F-504C provides 2 out of 8 horizontal sub-sampling: see Figure 69 on page 159 Corrected: maximum gain for Stingray F-504B/C is 670 and not 680, see Chapter Manual gain on page 136 Corrected: Stingray F-504B/C: range in dB is 0 to 24.053 (not 24.4), see Chapter Manual gain on page 136 and Chapter Stingray F-504B/F-504C on page 82 Changed: number of steps from ± 40 to ± 128 in steps of $1/12.8^\circ$ in Chapter Hue and saturation on page 178 <p>Changed fixed format modes and Format 7 modes:</p> <ul style="list-style-type: none"> Table 81 on page 220 Table 97 on page 241 Table 98 on page 242 Table 99 on page 243 Table 100 on page 244 Table 101 on page 245 Table 102 on page 246 Table 103 on page 247 Table 104 on page 248

Table 1: Document history (continued)

Version	Date	Remarks
V4.4.3 [continued]	2012-Mar-15 [continued]	<p>More smaller corrections:</p> <ul style="list-style-type: none"> Removed Active FirePackage in the last line of specification tables in Chapter Specifications on page 59 Added explanations to H, p and q abbreviations in Chapter Frame rates on page 236 Added hyperlinks to Stingray compact in Chapter Camera dimensions on page 85 Added Table 39 on page 122 Added Raw12 format in sharpness Note on page 178 Added arrow for Raw8/12/16 in Table 46 on page 126 High SNR mode: Added note to set grab count and activation of HighSNR in one single write access: <ul style="list-style-type: none"> see Chapter High SNR mode (High Signal Noise Ratio) on page 171 Chapter High SNR mode (High Signal Noise Ratio) on page 316
V4.4.4	2012-May-31	<p>New frame rates for Stingray F-033/F-033 BL:</p> <ul style="list-style-type: none"> See Chapter Stingray F-033B/F-033C (incl. board level): AOI frame rates on page 241
V.4.4.5	2014-Jul-31	<p>Updated data:</p> <ul style="list-style-type: none"> Replaced spectral curves according to Allied Vision EMVA 1288 measurements in chapter Absolute quantum efficiency on page 56 <p>Some smaller corrections:</p> <ul style="list-style-type: none"> Corrected hyperlinks to targets on the Allied Vision website Removed outdated information in Chapter Requirements for PC and IEEE 1394b on page 55 Added hyperlink to FireWire accessories on the Allied Vision website in Chapter Requirements for PC and IEEE 1394b on page 55 Removed information on the Universal Package in Chapter Operating system support on page 58 Reduced to the current information on the system requirements in Chapter Operating system support on page 58 Added information that all color modes in Chapter Specifications on page 59 comply with the IIDC specifications

Table 1: Document history (continued)

Version	Date	Remarks
V.4.5.0	2015-Mar-09	<p>Updated data:</p> <ul style="list-style-type: none"> • Corrected hyperlinks to targets on the Allied Vision website • Updated sensor curves in chapter Absolute quantum efficiency on page 56. • Corrected information in Chapter Appendix on page 336 • Adapted addresses in Chapter Contact us on page 15 • Corrected information for binning in Chapter Definition on page 153. • Corrected information in Chapter Sensor position accuracy of Stingray cameras on page 336 <p>Layout changes due to a changed Corporate identity:</p> <ul style="list-style-type: none"> • Replaced the previous Allied Vision logo by the current one • Reworded all appropriate contents from AVT and Allied Vision Technologies to Allied Vision
V4.6.0	2016-Jun-30	<p>Updated data:</p> <ul style="list-style-type: none"> • Added non-volatile memory (Flash) for Stingray cameras with S/N 319438848 to 335544319 to Chapter Specifications on page 59 • Added new feature information in Chapter Permanent Data Storage on page 295 (Stingray cameras with S/N 319438848 to 335544319) • Corrected typos and broken links. • Added a note about Hirose I/O connectors in Chapter Camera I/O connections on page 102 • Updated absolute QE plots • Added spectral response plots • Added absolute QE and spectral response notes • Removed the Stingray Compact as this model is being discontinued
V4.6.1	2016-Dec-07	<p>Updated data:</p> <ul style="list-style-type: none"> • Reorganized and added information in Chapter Regulations on page 26 • Added note about accuracy of measurements for quantum efficiency in Chapter Specifications on page 59 • Updated sensor curves for quantum efficiency and spectral response in Chapter Specifications on page 59 • Removed references to glass optical fiber (GOF) options.
V4.6.2	2017-Apr-10	<p>Added cable color to camera I/O connector pin assignment including pin assignment figure and cross reference to the Allied Vision I/O cable data sheet</p>

Table 1: Document history (continued)

Version	Date	Remarks
V4.6.3	2017-Oct-12	Updated data for camera type IDs in Table 128 on page 289.
V4.6.4	2018-Jan-05	Applied minor changes.
V4.6.5	2019-Jan-02	<ul style="list-style-type: none"> Added contents for camera EMC compliance in Chapter Camera I/O connections on page 102. Applied minor changes. Corrected typos.
V4.6.6	2019-Feb-27	Applied editorial changes.
V4.6.7	2019-Jul-15	Applied editorial changes.
V4.6.8	2019-Sep-13	Applied editorial changes.
V4.6.9	2020-May-25	<ul style="list-style-type: none"> Updated data in Chapter Compliance, safety, and intended use on page 43 and in Chapter Intended use on page 45. Updated spectral plots. Added data in Chapter Read before use on page 2, Chapter Your safety on page 45, Chapter Avoiding material damage on page 47, and Chapter Warranty note on page 48. Applied minor editorial changes.
V4.7.0	2021-Jul-13	Applied editorial changes.
V4.7.1	2021-Aug-19	<ul style="list-style-type: none"> Added icon for compliance with UKCA in Chapter Compliance notifications on page 43. Applied minor editorial changes.
V4.8.0	2022-Aug-22	<ul style="list-style-type: none"> Renamed the document from Technical Manual to User Guide. Added Hebrew contents to Chapter Read before use on page 2.
V4.8.1	2023-Jan-27	<ul style="list-style-type: none"> Added note that lenses are not part of the product. Updated Hebrew contents in Chapter Read before use on page 2.
V4.8.2	2023-Jul-10	Applied editorial changes.

Table 1: Document history (continued)

Manual overview

This manual overview describes each chapter of this manual shortly.

- Chapter [Contact us](#) on page 15 lists Allied Vision contact data for both:
 - technical information / ordering
 - commercial information
- Chapter [Introduction](#) on page 25 (this chapter) gives you the document history, a manual overview and conventions used in this manual (styles and symbols). Furthermore, you learn how to get more information on how

to install hardware (1394 Installation Manual), available Allied Vision software (including documentation) and where to get it.

- Chapter [Stingray cameras](#) on page 42 gives you a short introduction to the Stingray cameras with their FireWire technology. Links are provided to data sheets and brochures on Allied Vision website.
- Chapter [Compliance, safety, and intended use](#) on page 43 and in Chapter [Intended use](#) on page 45 give you information about conformity and intended use of Allied Vision cameras.
- Chapter [FireWire](#) on page 49 describes the FireWire standard in detail, explains the compatibility between IEEE 1394a and IEEE 1394b and explains bandwidth details (including Stingray examples).
 - Read and follow the FireWire hot-plug and screw-lock precautions in Chapter [FireWire hot-plug and screw-lock precautions](#) on page 57.
 - Read Chapter [Operating system support](#) on page 58.
- Chapter [Filter and lenses](#) on page 97 describes the IR cut filter and suitable camera lenses.
- Chapter [Specifications](#) on page 59 lists camera details and absolute quantum efficiency plots for each camera type.
- Chapter [Camera dimensions](#) on page 85 provides CAD drawings of standard housing models, tripod adapter, available angled head models, cross sections of CS-Mount and C-Mount.
- Chapter [Camera interfaces](#) on page 100 describes in detail the inputs/ outputs of the cameras (including Trigger features). For a general description of the interfaces (FireWire and I/O connector) see the 1394 Installation Manual.
- Chapter [Description of the data path](#) on page 125 describes in detail IIDC conform as well as Allied Vision-specific camera features.
- Chapter [Controlling image capture](#) on page 186 describes trigger modes, exposure time, one-shot/multi-shot/ISO_Enable features. Additionally, special Allied Vision features are described: sequence mode and secure image signature (SIS).
- Chapter [Video formats, modes and bandwidth](#) on page 215 lists all available fixed and Format_7 modes (including color modes, frame rates, binning/sub-sampling, AOI=area of interest).
- Chapter [How does bandwidth affect the frame rate?](#) on page 249 gives some considerations on bandwidth details.
- Chapter [Configuration of the camera](#) on page 253 lists standard and advanced register descriptions of all camera features.
- Chapter [Firmware update](#) on page 335 explains where to get information on firmware updates and explains the extended version number scheme of FPGA/microcontroller.
- Chapter [Appendix](#) on page 336 lists the sensor position accuracy of Allied Vision cameras.
- Chapter [Index](#) on page 337 gives you quick access to all relevant data in this manual.

Conventions used in this manual

To give this manual an easily understood layout and to emphasize important information, the following typographical styles and symbols are used:

Styles

Style	Function	Example
Bold	Programs, inputs or highlighting important things	bold
Courier	Code listings etc.	Input
Upper case	Register	REGISTER
Italics	Modes, fields	<i>Mode</i>
Parentheses and/or blue	Links	(Link)

Table 2: Styles

Symbols and notes



CAUTION

Risk of burns

Precautions are described



CAUTION

Injury by falling cameras or lenses

Precautions are described



CAUTION

Risk of cuts by sharp edges of lens mounts

Precautions are described

Note _____ This symbol highlights important information.



Caution

This symbol highlights important instructions. You have to follow these instructions to avoid malfunctions.

**www**

This symbol highlights URLs for further information. The URL itself is shown in blue.



Example:

www.alliedvision.com

More information

For more information on hardware and software read the following:

1394 Installation Manual describes the hardware installation procedures for all IEEE 1394 cameras (Marlin, Guppy, Pike, Stingray). Additionally, you get safety instructions and information about camera interfaces (IEEE 1394a/b copper and GOF, I/O connectors, input and output).

www

You find the 1394 Installation Manual here:



www.alliedvision.com/en/support/technical-documentation

www

All software packages (including documentation and release notes) provided by Allied Vision can be downloaded at:



www.alliedvision.com/en/support/software-downloads

Before operation

We place the highest demands for quality on our cameras.

Target group. This Technical Manual is the guide to detailed technical information of the camera and is written for experts.

Getting started. For a quick guide how to get started read 1394 Installation Manual first.

Note Please read through this manual carefully before operating the camera.



For information on Allied Vision accessories and software read 1394 Installation Manual.

Caution Before operating any Allied Vision camera read safety instructions and ESD warnings in 1394 Installation Manual.



Note To demonstrate the properties of the camera, all examples in this manual are based on the FirePackage OHCI API software and the SmartView application.



Note The camera also works with all IIDC (formerly DCAM) compatible IEEE 1394 programs and image processing libraries.



All naming in this document relates to FirePackage, not to GenICam.

www For downloads see:



Software (Vimba and all other software):
www.alliedvision.com/en/support/software-downloads

Firmware:
www.alliedvision.com/en/support/firmware-downloads

Technical documentation (overview page):
www.alliedvision.com/en/support/technical-documentation

Application notes:
www.alliedvision.com/en/support/faqs-application-notes

Stingray cameras

IEEE 1394b With the Stingray, Allied Vision presents a wide range of cameras with **IEEE 1394b interfaces**. Moreover, with daisy chain they gain the highest level of acceptance for demanding areas of use in manufacturing industry.

Image applications Allied Vision can provide users with a range of products that meet almost all the requirements of a very wide range of image applications.

FireWire The industry standard IEEE 1394 (FireWire or i.Link) facilitates the simplest computer compatibility and bidirectional data transfer using the plug-and-play process. Further development of the IEEE 1394 standard has already made 800 Mb/second possible.

Note For further information on **FireWire** read chapter [FireWire](#) on page 49.



Note **All naming in this document relates to FirePackage, not to GenICam.**



www For further information on the highlights of Stingray types and the Stingray family read the data sheets and brochures on the website of Allied Vision:



www.alliedvision.com/en/support/technical-documentation/stingray-documentation

Compliance, safety, and intended use

Compliance notifications

For customers in China and Europe



National regulations on disposal must be followed.

For customers in the USA

FCC Class B digital device

This equipment has been tested and found to comply with the limits for a Class B digital device, pursuant to part 15 of the FCC Rules. These limits are designed to provide reasonable protection against harmful interference in a residential installation. This equipment generates, uses and can radiate radio frequency energy and, if not installed and used in accordance with the instructions, may cause harmful interference to radio communications. However, there is no guarantee that interference will not occur in a particular installation. If this equipment does cause harmful interference to radio or television reception, which can be determined by turning the equipment off and on, the user is encouraged to try to correct the interference by one or more of the following measures:

- Reorient or relocate the receiving antenna.
- Increase the separation between the equipment and receiver.
- Connect the equipment into an outlet on a circuit different from that to which the receiver is connected.
- Consult the dealer or an experienced radio/TV technician for help.

United States of America: Supplier Declaration of Conformity

Stingray cameras comply with Part 15 of the FCC Rules. Operation is subject to the following two conditions:

1. This device may not cause harmful interference, and
2. this device must accept any interference received, including interference that may cause undesired operation.

Party issuing Supplier's Declaration of Conformity

Allied Vision Technologies GmbH
Taschenweg 2a
07646 Stadtroda
Germany
T// +49 (36428) 677-106
quality@alliedvision.com

Responsible Party - U.S. Contact Information

Allied Vision Technologies, Inc.
102 Pickering Way – Suite 502
Exton, PA 19341
USA
T// +1 978 225 2030

Note: changes or modifications not expressly approved by the party responsible for compliance could void the user's authority to operate the equipment.

For customers in Canada

This apparatus complies with the Class B limits for radio noise emissions set out in the Radio Interference Regulations.

CAN ICES-3 (B) / NMB-3 (B)

Pour utilisateurs au Canada

Cet appareil est conforme aux normes classe B pour bruits radioélectriques, spécifiées dans le Règlement sur le brouillage radioélectrique.

CAN ICES-3 (B) / NMB-3 (B)

Board level models

Board level models are designed for integration and are delivered without housing on customer's request. Because housing design is critical to the electromagnetic compatibility (EMC) of a camera, no certification tests regarding electromagnetic interference have been performed for these models. Users who design board level models into their systems should perform appropriate testing regarding EMC after the product design is completed. Compliance with requirements not EMC-related remains unaffected.

Avoid electromagnetic interferences

For all power and interface connections, only use shielded cables or cables recommended by Allied Vision.

Intended use

Allied Vision's objective is the development, design, production, maintenance, servicing and distribution of digital cameras and components for image processing. We are offering standard products as well as customized solutions. Intended use of Allied Vision product is the integration into Vision systems by professionals. All Allied Vision product is sold in a B2B setting.

Allied Vision isn't a legal manufacturer of medical product. Instead, Allied Vision cameras and accessories may be used as components for medical product after design-in by the medical device manufacturer and based on a quality assurance agreement (QAA) between Allied Vision (supplier) and medical device manufacturer (customer). Allied Vision's duties in that respect are defined by ISO 13485, clause 7.2 (customer-related processes, equivalent to ISO 9001, clause 8.2).

Copyright and trademarks

All text, pictures, and graphics are protected by copyright and other laws protecting intellectual property. All content is subject to change without notice. All trademarks, logos, and brands cited in this document are property and/or copyright material of their respective owners. Use of these trademarks, logos, and brands does not imply endorsement.

Copyright © 2023 Allied Vision Technologies GmbH. All rights reserved.

Your safety

This section informs about issues related to your personal safety. Descriptions explain how to avoid hazards and operate Stingray cameras safely.

Handling lens mounts

The lens mount thread has sharp edges. Be careful these edges do not cut your skin when mounting or unmounting lenses.

Handling hot cameras

If you hold the camera in your hands during operation, your skin may get hurt. If you touch the camera when it is heated up, we recommend wearing protective gloves.

Providing optimum heat dissipation

Keep the operating temperature in the specified range to enable best image quality and to protect the camera from damage. Temperature values apply to a relative humidity of 0 to 80 percent that is non-condensing.

For your safety and to improve camera performance, operate the camera:

- Mounted to a base with a high thermal conductivity
- With lens or other optical components mounted
- With a heat sink mounted that has large surface areas (closed housing cameras include a heat sink)
- Using conductive media for camera and heat sink mounting
- With active cooling of camera, mounting base, and heat sink, such as by ventilation

Camera mounting

Cameras must be mounted using the mounting threads. If vibration is very high, cameras can disconnect from the mounting. Falling cameras can hurt you.

For heavy or long lenses, we recommend you to use a lens support and apply additional tests.

Avoiding material damage

Electronics maintenance

There are no switches or parts inside the camera housing that require adjustment. The warranty becomes void upon opening the camera casing.

Cable connections

Powering cameras

Operating the camera beyond the specified range damages the camera.

The camera does not generate dangerous voltages internally. However, because the IEEE 1394 standard permits cable power distribution at voltages higher than 24 V DC, various international safety standards apply.

Cameras can be powered using the I/O connector at an input range of 8 to 36 VDC, using a limited power source (LPS), according to IEC 62368-1 with minimum 2 A. The camera is not intended to be connected to a DC distribution network. The maximum length for I/O cables must not exceed 30 meters.

Only use power supplies that meet the insulation requirement according to PELV or SELV. For details, please refer to IEC 61140.

If using external power supplies by third-party manufacturers, observe polarity to avoid damage to the camera electronics.

If you feel uncomfortable with the following advice or if you have no knowledge about the connectivity of an installation, we strongly recommend powering down all systems before connecting or disconnecting a camera.

No hot plugging

Although FireWire devices can theoretically be hot-plugged without powering down equipment, we strongly recommend turning the computer power off before connecting a digital camera to it via a FireWire cable.

Static electricity or slight plug misalignment during insertion may short-circuit and damage components.

Avoiding electrostatic discharge (ESD)

The physical ports may be damaged by excessive ESD when connected under powered conditions. It is good practice to ensure proper grounding of computer case and camera case to the same ground potential before plugging the camera cable into the port of the computer. This ensures that no excessive difference of electrical potential exists between computer and camera.

Make sure not to touch the shield of the camera cable connected to a computer and the ground terminal of the lines at the same time. If you are charged: before touching the shield of the camera cable, make sure to discharge first (by touching the ground terminal of the lines).

Maximum inrush current

It is very important not to exceed an inrush current of 18 mJoule in 3 ms. (This means that a device, when powered via 12 VDC bus power, must never draw more than 1.5 A, even not in the first 3 ms.)

Higher inrush current may damage the physical interface chip of the camera and/or the phy chip in your PC.

Whereas inrush current is not a problem for a single 1394b camera, daisy chaining multiple cameras or supplying bus power via (optional) HIROSE power out to circuitry with unknown inrush currents needs careful design considerations to be on the safe side.

Suitable accessories

All Allied Vision 1394b camera and cables have industrial screw-lock fasteners to insure a tight electrical connection that is resistant to vibration and gravity.

We strongly recommend using only 1394b adapter cards with screw-locks.

Use only DC power supplies with insulated cases. These are identified by having only two power connectors.

Cleaning cameras

Mount/remove lenses and filters in a dust-free environment. Use only quality optical tissue/cloth if you must clean a lens or filter. Read the 1394 Installation Manual, Chapter Cleaning instructions.

Warranty note

If the product is disassembled, reworked, repaired or cleaned by unauthorized service personnel, Allied Vision or its suppliers cannot be held liable for any subsequent performance decrease of the camera or quality decrease of the camera output.

FireWire

Overview

FireWire provides one of the most comprehensive, high-performance, and cost-effective solutions platforms. FireWire offers very impressive throughput at very affordable prices.

Definition

FireWire (also known as **i.Link** or **IEEE 1394**) is a personal computer and digital video serial bus interface standard, offering high-speed communications and isochronous real-time data services. FireWire has low implementation costs and a simplified and adaptable cabling system.



Figure 1: FireWire Logo

IEEE 1394 standards

FireWire was developed by Apple Computer in the late 1990s, after work defining a slower version of the interface by the IEEE 1394 working committee in the 1980s. Apple's development was completed in 1995. It is defined in the IEEE 1394 standard, which is currently a composite of three documents:

- Original IEEE Std. 1394-1995
- IEEE Std. 1394a-2000 amendment
- IEEE Std. 1394b-2002 amendment

FireWire is used to connect digital cameras, especially in industrial systems for machine vision.

Note

All naming in this document relates to FirePackage, not to GenICam.



Why use FireWire?

Digital cameras with on-board FireWire (IEEE 1394a or IEEE 1394b) communications conforming to the IIDC standard (V1.3 or V1.31) have created cost-effective and powerful solutions options being used for thousands of different applications around the world. FireWire is currently the premier robust digital interface for industrial applications for many reasons, including:

- Guaranteed bandwidth features to ensure fail-safe communications
- Interoperability with multiple different camera types and vendors
- Diverse camera powering options, including single-cable solutions up to 45 W
- Effective multiple-camera solutions
- Large variety of FireWire accessories for industrial applications
- Availability of repeaters and optical fiber cabling
- Forward and backward compatibility blending IEEE 1394a and IEEE 1394b
- Both real-time (isochronous) and demand-driven asynchronous data transmission capabilities

FireWire in detail

Serial bus

FireWire is a very effective way to utilize a low-cost serial bus, through a standardized communications protocol, that establishes packetized data transfer between two or more devices. FireWire offers real time isochronous bandwidth for image transfer with guaranteed low latency. It also offers asynchronous data transfer for controlling camera parameters on the fly, such as gain and shutter. As illustrated in the diagram below, these two modes can co-exist by using priority time slots for video data transfer and the remaining time slots for control data transfer.

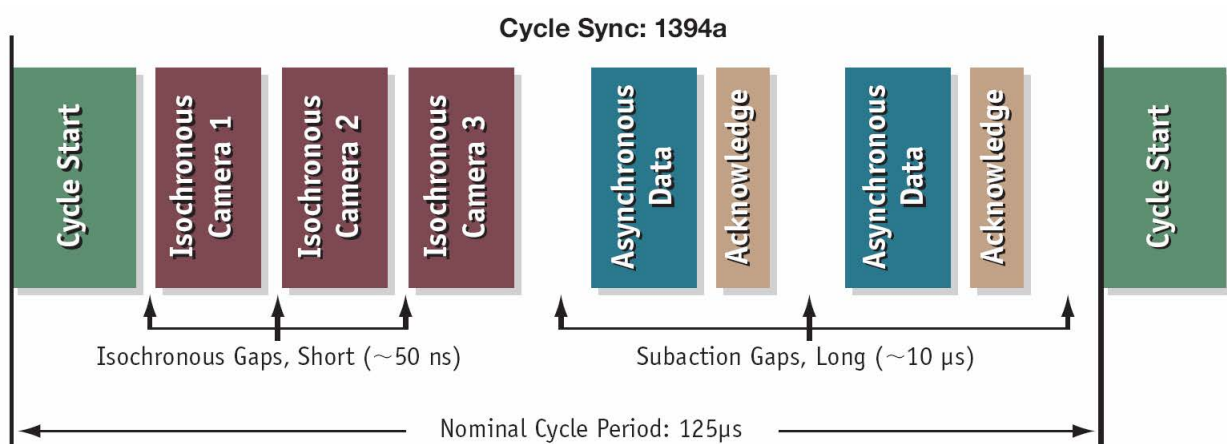

Figure 2: IEEE 1394a data transmission

Whereas IEEE 1394a works in half duplex transmission, IEEE 1394b does full duplex transmission. IEEE 1394b optimizes the usage of the bandwidth, as it does not need gaps between the signals like IEEE 1394a. This is due to parallel arbitration, handled by the bus owner supervisor selector (BOSS). For details see the following diagram:

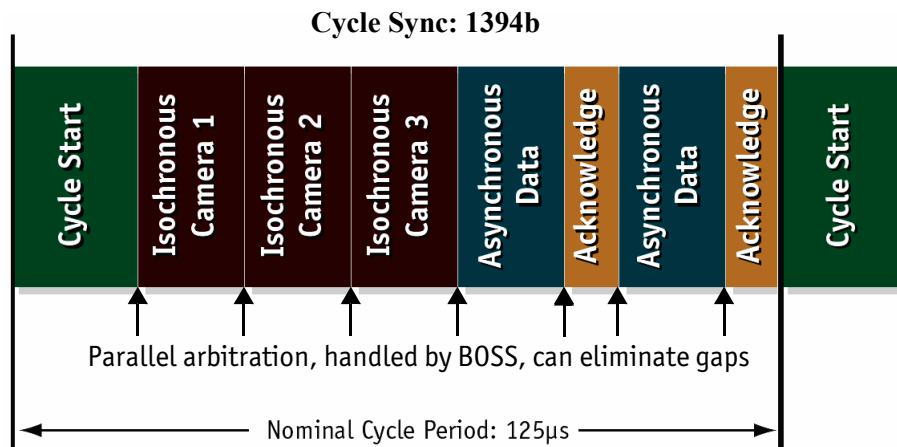

Figure 3: IEEE 1394b data transmission

Additional devices may be added up to the overall capacity of the bus, but throughput at guaranteed minimum service levels is maintained for all devices with an acknowledged claim on the bus. This deterministic feature is a huge advantage for many industrial applications where robust performance is required. This applies with applications that do not allow dropping images within a specific time interval.

FireWire connection capabilities

FireWire can connect together up to 63 peripherals in an acyclic network structure (hubs). It allows peer-to-peer device communication between digital cameras, without using system memory or the CPU.

A FireWire camera can directly, via direct memory access (DMA), write into or read from the memory of the computer with almost no CPU load.

FireWire also supports multiple hosts per bus. FireWire requires only a cable with the correct number of pins on either end (normally 6 or 9).

Caution



While supplying such an amount of bus power is clearly a beneficial feature, it is very important not to exceed the inrush current of 18 mJoule in 3 ms.

Higher inrush current may damage the PHY chip of the camera and/or the PHY chip in your PC.

Capabilities of IEEE 1394a (FireWire 400)

FireWire 400 (S400) is able to transfer data between devices at 100, 200, or 400 Mb/s data rates.

The IEEE 1394a capabilities in detail:

- 400 Mb/s
- Hot-pluggable devices
- Peer-to-peer communications
- Direct Memory Access (DMA) to host memory
- Guaranteed bandwidth
- Multiple devices (up to 45 W) powered via FireWire bus

IIDC V1.3 camera control standards

IIDC V1.3 released a set of camera control standards via IEEE 1394a, which established a common communications protocol on which most current FireWire cameras are based.

In addition to common standards shared across manufacturers, Allied Vision offers Format_7 mode that provides special features (smart features), such as:

- Higher resolutions
- Higher frame rates
- Diverse color modes

as extensions (advanced registers) to the prescribed common set.

Capabilities of IEEE 1394b (FireWire 800)

FireWire 800 (S800) was introduced commercially by Apple in 2003 and has a 9-pin FireWire 800 connector (see **1394 Installation Manual** and in chapter [IEEE 1394b port pin assignment](#) on page 100 for details). This newer IEEE 1394b specification allows a transfer rate of 800 Mb/s with backward compatibility to the slower rates and 6-pin connectors of FireWire 400.

The IEEE 1394b capabilities in detail:

- 800 Mb/s
- All previously described benefits of IEEE 1394a
- Interoperability with IEEE 1394a devices
- Longer communications distances (up to 500 m using GOF cables)

IIDC V1.31 camera control standards

Along with IEEE 1394b, the IIDC V1.31 standard arrived in January 2004, evolving the industry standards for digital imaging communications to include I/O and RS232 handling, and adding further formats. The increased bandwidths enable transmitting high-resolution images to the PC's memory at high frame rates.

Compatibility between IEEE 1394a and IEEE 1394b



 <p>1394b port</p> <p>1394a camera</p> <p>IEEE 1394a camera connected to IEEE 1394b bus</p> <p>The cable explains dual compatibility: This cable serves to connect an IEEE 1394a camera with its six-pin connector to a bilingual port (a port which can talk in a- or b-language) of a IEEE 1394b bus.</p> <p>In this case, the b-bus communicates in a-language and a-speed with the camera achieving a-performance</p>	 <p>1394b camera</p> <p>1394a port</p> <p>IEEE 1394b camera connected to IEEE 1394a bus</p> <p>The cable explains dual compatibility: In this case, the cable connects an IEEE 1394b camera with its nine-pin connector to a IEEE 1394a port.</p> <p>In this case, the b-camera communicates in a-language with the camera achieving a-performance</p>
---	---

Figure 4: IEEE 1394a and IEEE 1394b cameras and compatibility

Compatibility example

It is possible to run a IEEE 1394a and a IEEE 1394b camera on the IEEE 1394b bus.

For example, you can run a Stingray F-033B and a Marlin F-033B on the same bus:

- Stingray F-033B @ S800 and 60 fps (2560 bytes per cycle, 32% of the cycle slot)
- Marlin F-033B @ S400 and 30 fps (1280 bytes, 32% of the cycle slot)

Bus runs at 800 Mb/s for all devices. Data from Marlin's port is up-converted from 400 Mb/s to 800 Mb/s by data doubling (padding), still needing 32% of the cycle slot time. This doubles the bandwidth requirement for this port, as if the camera were running at 60 fps. Total consumption is thus $2560 + 2560 = 5120$ bytes per cycle.

Image transfer via IEEE 1394a and IEEE 1394b

Technical detail	IEEE 1394a	IEEE 1394b
Transmission mode	Half duplex (both pairs needed) 400 Mb/s data rate aka: a-mode, data/strobe (D/S) mode, legacy mode	Full duplex (one pair needed) 1 Gb/s signaling rate, 800 Mb/s data rate 10b/8b coding (Ethernet), aka: b-mode (beta mode)
Devices	Up to 63 devices per network	
Number of cameras	Up to 16 cameras per network	
Number of DMAs	4 to 8 DMAs (parallel) cameras / bus	
Real time capability	Image has real time priority	
Available bandwidth acc. IIDC (per cycle 125 µs)	4096 bytes per cycle ~ 1000 quadlets @ 400 Mb/s	8192 bytes per cycle ~ 2000 quadlets @ 800 Mb/s (@1 GHz clock rate)
	For further detail read chapter Frame rates on page 236.	
Maximum image bandwidth	31.25 MB/s	62.5 MB/s
Maximum total bandwidth	~45 MB/s	~85 MB/s
Number of busses	Multiple busses per PC limit: PCI bus	Multiple busses per PC limit: PCI (Express) bus
CPU load	Almost none for DMA image transfer	
Gaps	Gaps negatively affect asynchronous performance of widespread network (round trip delay), reducing efficiency	No gaps needed, BOSS mode for parallel arbitration

Table 3: Technical detail comparison: IEEE 1394a and IEEE 1394b

Note

The bandwidth values refer to the fact:

1 MB = 1024 KB



IEEE 1394b bandwidths

According to the IEEE 1394b specification on isochronous transfer, the largest recommended data payload size is 8192 bytes per 125 μ s cycle at a bandwidth of 800 Mb/s.

Note



Certain cameras may offer, depending on their settings in combination with the use of FirePackage higher packet sizes.

Consult your local Allied Vision distributor's support team, if you require additional information on this feature.

Note



How to extend the size of an isochronous packet up to 11.000 byte at S800:

- See register 0xF1000048, ADV_INQ_3, Max IsoSize [1] in [Table 129](#): on page 290
- See chapter [Maximum ISO packet size](#) on page 317

For further details read chapter [How does bandwidth affect the frame rate?](#) on page 249.

Requirements for PC and IEEE 1394b

Note



For FireWire accessories see:

www.alliedvision.com/en/products/accessories

Caution



As mentioned earlier, it is very important not to exceed an inrush energy of 18 mWs in 3 ms. (This means that a device, when powered via 12 V bus power, must never draw more than 1.5 A, especially in the first 3 ms.)

Higher inrush current may damage the physical interface chip of the camera and/or the PHY chip in your PC.

For a single Stingray camera inrush current may not be a problem. But daisy chaining multiple cameras or supplying bus power via (optional) Hirose power out to circuitry with unknown inrush currents needs careful design considerations.

Example 1: IEEE 1394b bandwidth of Stingray cameras

Stingray model	Resolution	Frame rate	Bandwidth
Stingray F-033B/F-033C	0.3 megapixel	84 fps	27.11 MB/s
Stingray F-046B/F-046C	0.45 megapixel	61 fps	27.60 MB/s
Stingray F-080B/F-080C	0.8 megapixel	31 fps	24.83 MB/s
Stingray F-125B/F-125C	1.25 megapixel	30 fps	36.49 MB/s
Stingray F-145B/F-145C	1.44 megapixel	16 fps	23.05 MB/s
Stingray F-146B/F-146C	1.44 megapixel	15 fps	21.61 MB/s
Stingray F-201B/F-201C	2 megapixel	14 fps	17.20 MB/s
Stingray F-504B/F-504C	5 megapixel	9 fps	45.35 MB/s

Table 4: Bandwidth of Stingray cameras

Note

All data are calculated using Raw8 / Mono8 color mode. Higher bit depths or color modes will double or triple bandwidth requirements.

Example 2: More than one Stingray camera at full speed

Depending on its settings, a single Stingray camera can saturate a 32-bit PCI bus. Either use a PCI Express card and/or multiple 64-bit PCI bus cards, if you want to use 2 or more Stingray cameras simultaneously (see the following table):

Number of cameras	PC hardware required
One Stingray camera at full speed	1 x 32-bit PCI bus card (85 MB/s)
Two or more Stingray cameras at full speed	PCI Express card and/or Multiple 64-bit PCI bus cards

Table 5: Required hardware for multiple camera applications

FireWire Plug & play capabilities

FireWire devices implement the ISO/IEC 13213 configuration ROM model for device configuration and identification to provide plug & play capability. All FireWire devices are identified by an IEEE EUI-64 unique identifier (an extension of the 48-bit Ethernet MAC address format) in addition to well-known codes indicating the type of device and protocols it supports. For further details read chapter [Configuration of the camera](#) on page 253.

FireWire hot-plug and screw-lock precautions

Caution



Hot-plug precautions

- Although FireWire devices can theoretically be hot-plugged without powering down equipment, we strongly recommend turning off the computer power, before connecting a digital camera to it.
- Static electricity or slight plug misalignment during insertion may short-circuit and damage components.
- The physical ports may be damaged by excessive electrostatic discharge (ESD), when connected under powered conditions. It is good practice to ensure proper grounding of computer case and camera case to the same ground potential, before plugging the camera cable into the port of the computer. This ensures that no excessive difference of electrical potential exists between computer and camera.
- As mentioned earlier, it is very important not to exceed the inrush energy of 18 mWs in 3 ms. (This means that a device, when powered via 12 V bus power, must never draw more than 1.5 A, especially in the first 3 ms.)
- Higher inrush current may damage the physical interface chip of the camera and/or the PHY chip in your PC. For a single Stingray camera inrush current may not be a problem. But daisy chaining multiple cameras or supplying bus power via (optional) Hirose power out to circuitry with unknown inrush currents needs careful design considerations.

Screw-lock precautions

- All Allied Vision IEEE 1394b camera and cables have industrial screw-lock fasteners to insure a tight electrical connection that is resistant to vibration and gravity.
- We strongly recommend using only IEEE 1394b adapter cards with screw-locks.

Operating system support

Operating system	IEEE 1394a	IEEE 1394b
Linux	Full support	Full support
Apple MacOS	Full support	Full support
Microsoft Windows XP	Full support	<p>With SP3 the default speed for IEEE 1394b is S100 (100 Mb/s). A download and registry modification is available from Microsoft to restore performance to either S400 or S800.</p> <p>The Windows IEEE 1394 driver only supports IEEE 1394a.</p> <p>For IEEE 1394b use either the FirePackage or install the driver provided with the IEEE 1394 Bus Driver Package. (Both drivers replace the Microsoft OHCI IEEE 1394 driver, but the second is 100% compliant to the driver of Microsoft. This way, applications using the MS1394 driver will continue to work.)</p>
Microsoft Windows Vista	Full support	<p>Windows Vista including SP1/SP2 supports IEEE 1394b only with S400.</p> <p>The Windows IEEE 1394 driver only supports IEEE 1394a.</p> <p>For IEEE 1394b use either the FirePackage or install the driver provided with the IEEE 1394 Bus Driver Package. (Both drivers replace the Microsoft OHCI IEEE 1394 driver, but the second is 100% compliant to the driver of Microsoft. This way, applications using the MS1394 driver will continue to work.)</p>
Microsoft Windows 7	Full support	Full support
Microsoft Windows 8	Full support	Full support

Table 6: FireWire and operating systems

www

For more information see Allied Vision Software:

www.alliedvision.com



Specifications

Note



- For information on bit/pixel and byte/pixel for each color mode see [Table 105](#) on page 249.
- **Maximum protrusion** means the **distance from lens flange to the glass filter in the camera.**

Note



Permanent data storage (PDS)

Stingray cameras with S/N 319438848 to 335544319 have a **non-volatile memory (Flash)** to permanently store images on the camera.

Stingray cameras with S/N 285884416 to 301989887 do not have this feature.

For details, see specifications table of your Stingray model.

For a description of PDS, see chapter [Permanent Data Storage](#) on page 295.

Absolute quantum efficiency

Note

Measurements for color cameras were done with IR cut filter, measurements for monochrome and S-Mount cameras were done without optical filters. With optical filters, QE decreases by approximately 10 percent. The uncertainty in measurement of the QE values is ± 10 percent. This is mainly due to uncertainties in the measuring apparatus itself (such as Ulbricht sphere and optometer).

Manufacturing tolerance of the sensor increases overall uncertainty.

Note

Sony provides relative response curves in their sensor data sheets. To create the absolute QE plots shown in this chapter, the relative response was converted to a normalized QE response and then adjusted as per three measured QE values (at 448 nm, 529 nm, 632 nm) for color sensors and one measured QE value (at 529 nm) for monochrome sensors.

Note

The wavelength range in the absolute QE plots reflects the information available in the sensor manufacturer data sheet at the time of publishing. For additional wavelength information, contact the sensor manufacturer.

Spectral response plots

Note

The curves in the spectral response plots shown in this chapter were calculated from measured quantum efficiencies at 448 nm, 529 nm, and 632 nm. The shape of the curve is taken from the sensor data sheet but the values have been adjusted based on these measured values. The uncertainty in measurement of the spectral response values is ± 10 percent.

Stingray F-033B/F-033C

Feature	Specification
Image device	Sony CCD ICX414AL/AQ with HAD microlens Type 1/2 (diagonal 8 mm) progressive scan
Effective chip size	6.5 mm x 4.9 mm
Cell size	9.9 μm x 9.9 μm
Picture size (maximum)	656 x 492 pixels (Format_7 Mode_0)
Lens mount	C-Mount: 17.526 mm (in air); \varnothing 25.4 mm (32 tpi) maximum protrusion: 10.1 mm (see Table 28 on page 93) CS-Mount: 12.526 mm (in air), \varnothing 25.4 mm (32 tpi) maximum protrusion: 5.1 mm (see Table 27 on page 92)
ADC	14-bit
Color modes (IIDC)	F-033C: Raw8, Raw12, Raw16, Mono8, YUV422, YUV411, RGB8
Frame rates	Up to 60 fps, up to 84 fps in Format_7
Gain control	Manual: 0 to 24.4 dB (0.0359 dB/step); auto gain (select. AOI)
Shutter speed	31 μs to 67 s; auto shutter (select. AOI)
External trigger shutter	Programmable, trigger level control, single trigger, bulk trigger, programmable trigger delay
Image buffer (RAM)	32 MB, up to 50 frames for cameras with S/N 285884416 to 301989887 128 MB, up to 200 frames for cameras with S/N 319438848 to 335544319
Non-volatile memory (Flash)	No user access for cameras with S/N 285884416 to 301989887 User access: 256 KB for cameras with S/N 319438848 to 335544319
Look-up tables	User programmable (12 bit \rightarrow 10 bit); default gamma (0.45)
Smart functions	Auto gain control (AGC), auto exposure control (AEC), real-time shading correction, look-up table (LUT), 32 MB image memory, mirror, binning (F-033B only), sub-sampling, High SNR, deferred image transport, secure image signature (SIS), sequence mode, 4 storable user sets F-033C: auto white balance (AWB), color correction, hue, saturation, sharpness
I/O	Two configurable inputs, four configurable outputs RS232 port (serial port, IIDC V1.31)
Transfer rate	Up to 800 Mb/s
Digital interface	IEEE 1394b (IIDC V1.31), 2 x copper connectors (bilingual) (daisy chain)
Power requirements	8 to 36 VDC via IEEE 1394 cable or 12-pin Hirose
Power consumption	Typical < 3.5 W @ 12 VDC (full resolution and maximal frame rates)
Dimensions (L x W x H)	72.9 mm x 44 mm x 29 mm, including connectors (without tripod and lens)

Table 7: Stingray F-033B/F-033C camera specifications

Feature	Specification
Mass	92 g (without lens) for cameras with S/N ≤ 09/17-285831532 108 g (without lens) for cameras with S/N > 09/17-285831532
Operating temperature	+ 5 °C to + 45 °C ambient temperature (without condensation)
Storage temperature	- 10 °C to + 70 °C ambient temperature (without condensation)
Standard accessories	F-033B: protection glass F-033C: IR cut filter
Optional accessories	F-033B: IR cut filter, IR pass filter F-033C: protection glass
On request	Host adapter card, angled head, power out: 6 W (Hirose)
Software packages	www.alliedvision.com/en/support/software-downloads (free of charge)

Table 7: Stingray F-033B/F-033C camera specifications (continued)

Absolute QE

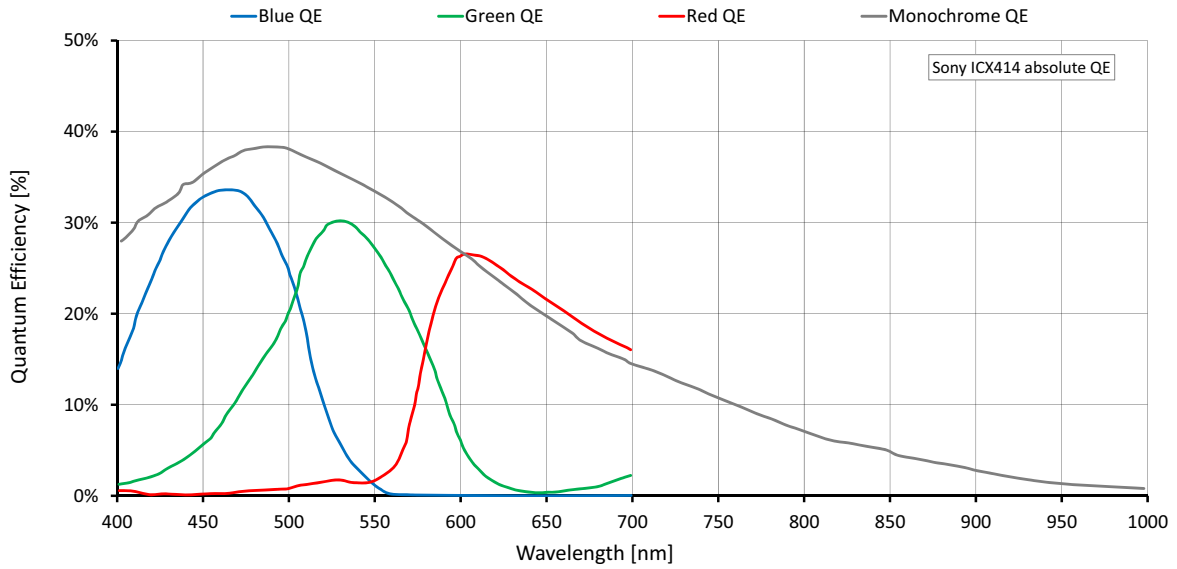

Figure 5: Stingray F-033B/F-033C (Sony ICX414) absolute QE plot

Spectral response

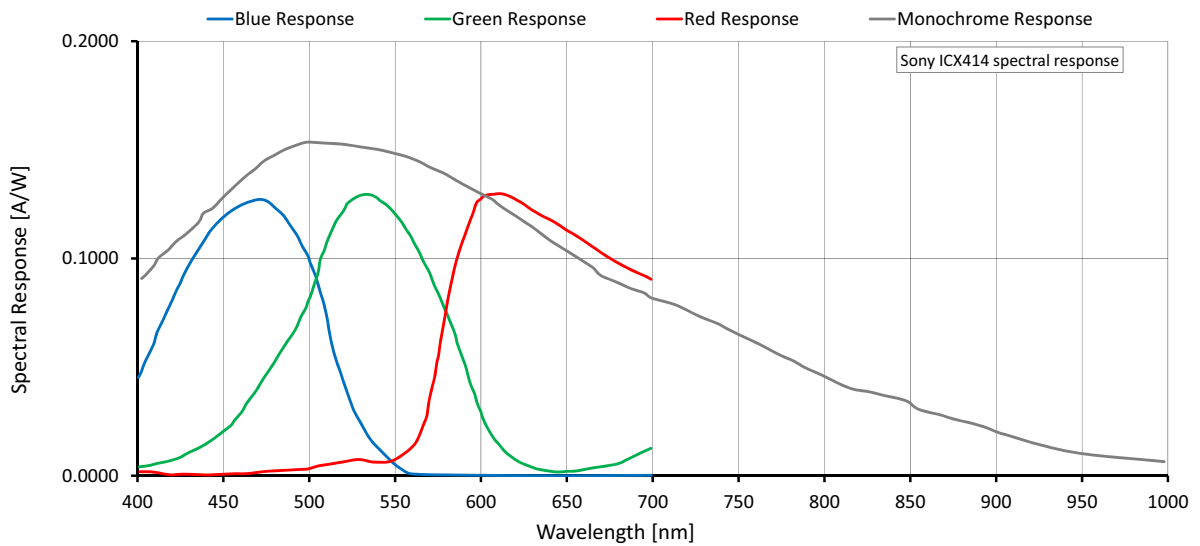

Figure 6: Stingray F-033B/F-033C (Sony ICX414) spectral response plot

Stingray F-046B/F-046C

Feature	Specification
Image device	Sony CCD ICX415AL/AQ with HAD microlens Type 1/2 (diagonal 8 mm) progressive scan
Effective chip size	6.5 mm x 4.8 mm
Cell size	8.3 μm x 8.3 μm
Picture size (maximum)	780 x 580 pixels (Format_7 Mode_0)
Lens mount	C-Mount: 17.526 mm (in air); Ø 25.4 mm (32 tpi) maximum protrusion: 10.1 mm (see Table 28 on page 93) CS-Mount: 12.526 mm (in air), Ø 25.4 mm (32 tpi) maximum protrusion: 5.1 mm (see Table 27 on page 92) Maximum protrusion means the distance from lens flange to the glass filter in the camera.
ADC	14-bit
Color modes (I IDC)	F-046C: Raw8, Raw12, Raw16, Mono8, YUV422, YUV411, RGB8
Frame rates	Up to 60 fps, up to 61 fps in Format_7
Gain control	Manual: 0 to 24.4 dB (0.0359 dB/step); auto gain (select. AOI)
Shutter speed	31 μs to 67 s; auto shutter (select. AOI)
External trigger shutter	Programmable, trigger level control, single trigger, bulk trigger, programmable trigger delay
Image buffer (RAM)	32 MB, up to 35 frames for cameras with S/N 285884416 to 301989887 128 MB, up to 140 frames for cameras with S/N 319438848 to 335544319
Non-volatile memory (Flash)	No user access for cameras with S/N 285884416 to 301989887 User access: 256 KB for cameras with S/N 319438848 to 335544319
Look-up tables	User programmable (12 bit → 10 bit); default gamma (0.45)
Smart functions	Auto gain control (AGC), auto exposure control (AEC), real-time shading correction, look-up table (LUT), 32 MB image memory, mirror, binning (F-046B only), sub-sampling, High SNR, deferred image transport, secure image signature (SIS), sequence mode, 4 storable user sets F-046C: auto white balance (AWB), color correction, hue, saturation
I/O	Two configurable inputs, four configurable outputs RS232 port (serial port, I IDC V1.31)
Transfer rate	Up to 800 Mb/s
Digital interface	IEEE 1394b (I IDC V1.31), 2 x copper connectors (bilingual) (daisy chain)
Power requirements	8 to 36 VDC via IEEE 1394 cable or 12-pin Hirose
Power consumption	Typical < 3.5 W @ 12 VDC (full resolution and maximal frame rates)

Table 8: Stingray F-046B/F-046C camera specifications

Feature	Specification
Dimensions (L x W x H)	72.9 mm x 44 mm x 29 mm, including connectors (without tripod and lens)
Mass	92 g (without lens) for cameras with S/N ≤ 09/17-285831532 108 g (without lens) for cameras with S/N > 09/17-285831532
Operating temperature	+ 5 °C to + 45 °C ambient temperature (without condensation)
Storage temperature	- 10 °C to + 70 °C ambient temperature (without condensation)
Standard accessories	F-046B: protection glass F-046C: IR cut filter
Optional accessories	F-046B: IR cut filter, IR pass filter F-046C: protection glass
On request	Host adapter card, angled head, power out: 6 W (Hirose)
Software packages	www.alliedvision.com/en/support/software-downloads (free of charge)

Table 8: Stingray F-046B/F-046C camera specifications (continued)

Absolute QE

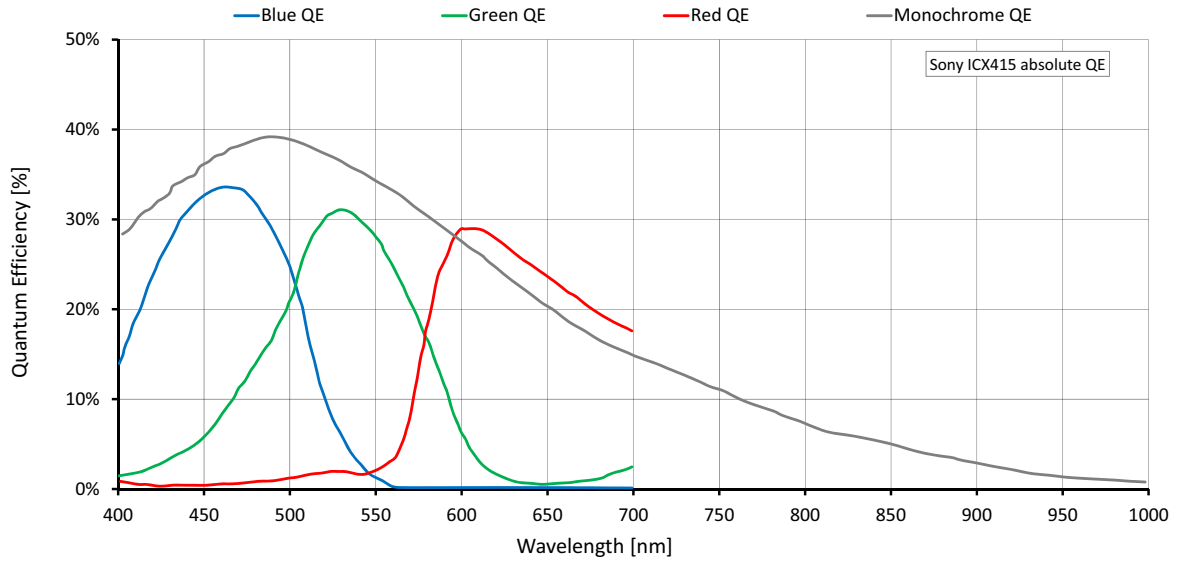

Figure 7: Stingray F-046B/F-046C (Sony ICX415) absolute QE plot

Spectral response

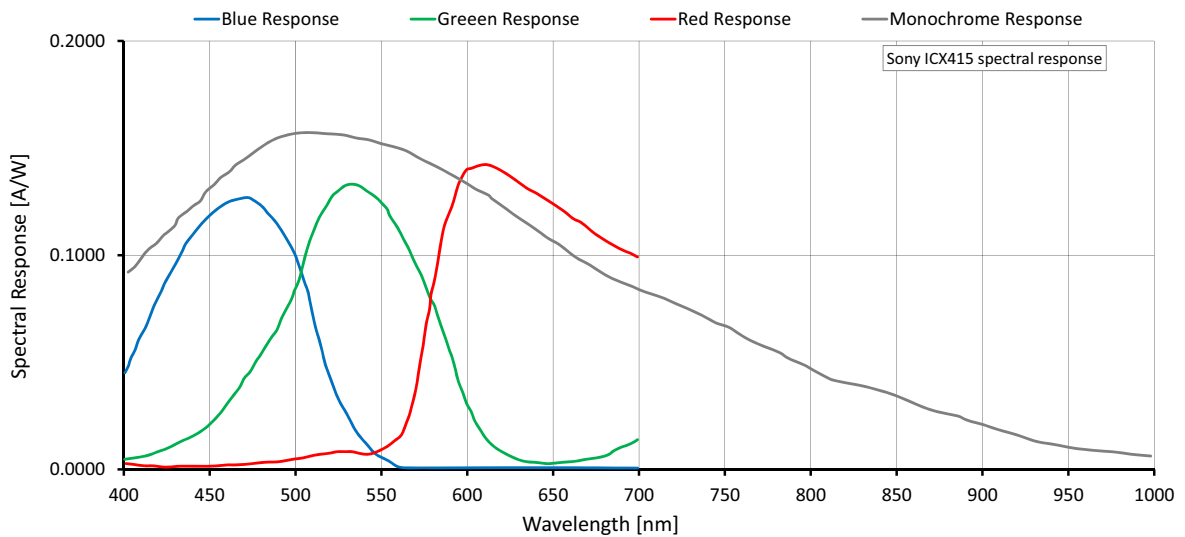

Figure 8: Stingray F-046B/F-046C (Sony ICX415) spectral response plot

Stingray F-080B/F-080C

Feature	Specification
Image device	Sony IT CCD ICX204AL/AK with HAD microlens Type 1/3 (diagonal 6 mm) progressive scan
Effective chip size	4.8 mm x 3.6 mm
Cell size	4.65 μm x 4.65 μm
Picture size (maximum)	1032 x 776 pixels (Format_7 Mode_0)
Lens mount	C-Mount: 17.526 mm (in air); \varnothing 25.4 mm (32 tpi) maximum protrusion: 10.1 mm (see Table 28 on page 93) CS-Mount: 12.526 mm (in air), \varnothing 25.4 mm (32 tpi) maximum protrusion: 5.1 mm (see Table 27 on page 92) Maximum protrusion means the distance from lens flange to the glass filter in the camera.
ADC	14-bit
Color modes (I IDC)	F-080C: Raw8, Raw12, Raw16, Mono8, YUV422, YUV411, RGB8
Frame rates	Up to 60 fps, up to 31 fps in Format_7
Gain control	Manual: 0 to 24.4 dB (0.0359 dB/step); auto gain (select. AOI)
Shutter speed	49 μs to 67 s; auto shutter (select. AOI)
External trigger shutter	Programmable, trigger level control, single trigger, bulk trigger, programmable trigger delay
Image buffer (RAM)	32 MB, up to 19 frames for cameras with S/N 285884416 to 301989887 128 MB, up to 76 frames for cameras with S/N 319438848 to 335544319
Non-volatile memory (Flash)	No user access for cameras with S/N 285884416 to 301989887 User access: 256 KB for cameras with S/N 319438848 to 335544319
Look-up tables	User programmable (12 bit \rightarrow 10 bit); default gamma (0.45)
Smart functions	Auto gain control (AGC), auto exposure control (AEC), real-time shading correction, look-up table (LUT), 32 MB image memory, mirror, binning (F-080B only), sub-sampling, High SNR, deferred image transport, secure image signature (SIS), sequence mode, 4 storable user sets F-080C: auto white balance (AWB), color correction, hue, saturation, sharpness
I/O	Two configurable inputs, four configurable outputs RS232 port (serial port, I IDC V1.31)
Transfer rate	Up to 800 Mb/s
Digital interface	IEEE 1394b (I IDC V1.31), 2 x copper connectors (bilingual) (daisy chain)
Power requirements	8 to 36 VDC via IEEE 1394 cable or 12-pin Hirose
Power consumption	Typical < 3.6 W @ 12 VDC (full resolution and maximal frame rates)

Table 9: Stingray F-080B/F-080C camera specifications

Feature	Specification
Dimensions (L x W x H)	72.9 mm x 44 mm x 29 mm, including connectors (without tripod and lens)
Mass	92 g (without lens) for cameras with S/N ≤ 09/17-285831532 108 g (without lens) for cameras with S/N > 09/17-285831532
Operating temperature	+ 5 °C to + 45 °C ambient temperature (without condensation)
Storage temperature	- 10 °C to + 70 °C ambient temperature (without condensation)
Standard accessories	F-080B: protection glass F-080C: IR cut filter
Optional accessories	F-080B: IR cut filter, IR pass filter F-080C: protection glass
On request	Host adapter card, angled head, power out: 6 W (Hirose)
Software packages	www.alliedvision.com/en/support/software-downloads (free of charge)

Table 9: Stingray F-080B/F-080C camera specifications (continued)

Absolute QE

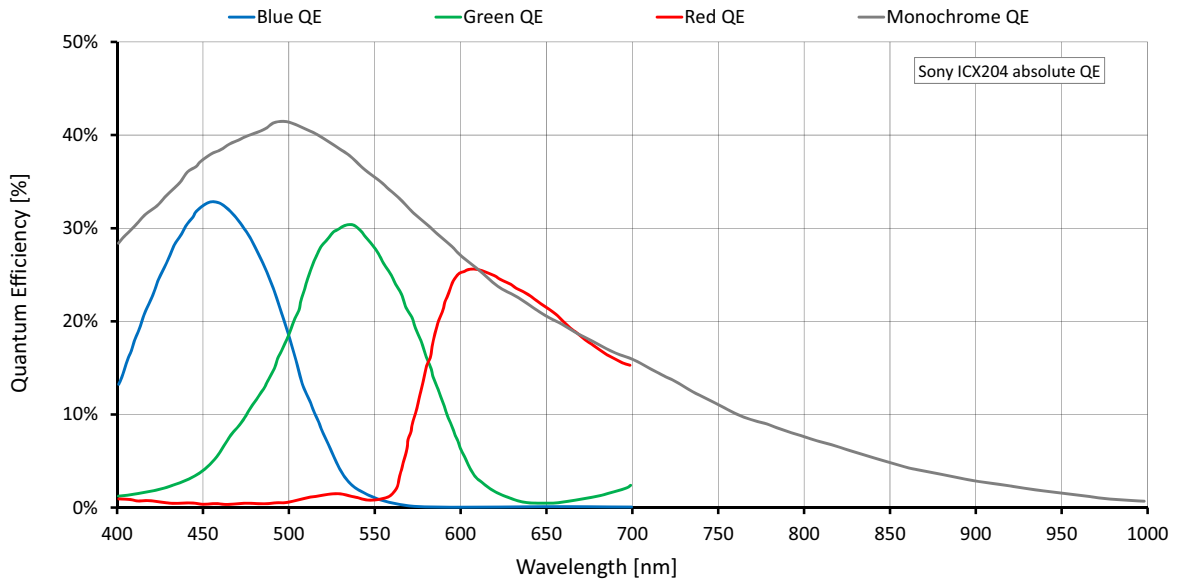

Figure 9: Stingray F-080B/F-080C (Sony ICX204) absolute QE plot

Spectral response

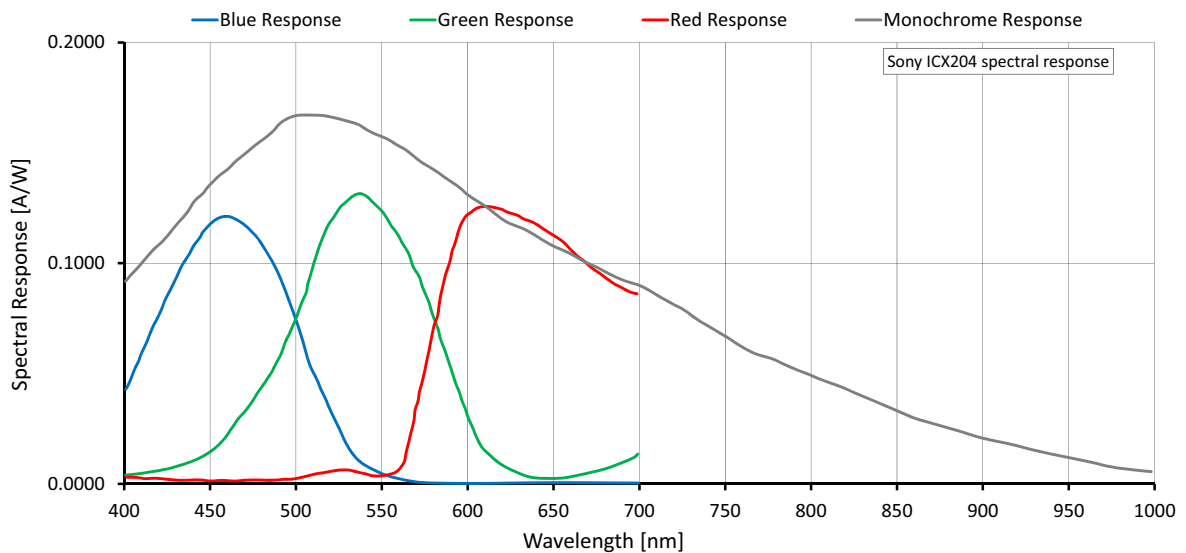

Figure 10: Stingray F-080B/F-080C (Sony ICX204) spectral response plot

Stingray F-125B/F-125C

Feature	Specification
Image device	Sony CCD ICX445ALA/AQA with EXview HAD microlens Type 1/3 (diagonal 6 mm) progressive scan
Effective chip size	4.8 mm x 3.6 mm
Cell size	3.75 μm x 3.75 μm
Picture size (maximum)	1292 x 964 pixels (Format_7 Mode_0)
Lens mount	C-Mount: 17.526 mm (in air); \varnothing 25.4 mm (32 tpi) maximum protrusion: 10.1 mm (see Table 28 on page 93) CS-Mount: 12.526 mm (in air), \varnothing 25.4 mm (32 tpi) maximum protrusion: 5.1 mm (see Table 27 on page 92) Maximum protrusion means the distance from lens flange to the glass filter in the camera.
ADC	14-bit
Color modes (I IDC)	F-125C: Raw8, Raw12, Raw16, Mono8, YUV422, YUV411, RGB8
Frame rates	Up to 60 fps, up to 30 fps in Format_7
Gain control	Manual: 0 to 24.4 dB (0.0359 dB/step); auto gain (select. AOI)
Shutter speed	25 μs to 67 s; auto shutter (select. AOI)
External trigger shutter	Programmable, trigger level control, single trigger, bulk trigger, programmable trigger delay
Image buffer (RAM)	32 MB, up to 12 frames for cameras with S/N 285884416 to 301989887 128 MB, up to 48 frames for cameras with S/N 319438848 to 335544319
Non-volatile memory (Flash)	No user access for cameras with S/N 285884416 to 301989887 User access: 256 KB for cameras with S/N 319438848 to 335544319
Look-up tables	User programmable (12 bit \rightarrow 10 bit); default gamma (0.45)
Smart functions	Auto gain control (AGC), auto exposure control (AEC), real-time shading correction, look-up table (LUT), 32 MB image memory, mirror, binning, sub-sampling, High SNR, deferred image transport, secure image signature (SIS), sequence mode, 4 storable user sets F-125C: auto white balance (AWB), color correction, hue, saturation, sharpness
I/O	Two configurable inputs, four configurable outputs RS232 port (serial port, I IDC V1.31)
Transfer rate	Up to 800 Mb/s
Digital interface	IEEE 1394b (I IDC V1.31), 2 x copper connectors (bilingual) (daisy chain)
Power requirements	8 to 36 VDC via IEEE 1394 cable or 12-pin Hirose
Power consumption	Typical < 3.6 W @ 12 VDC (full resolution and maximal frame rates)

Table 10: Stingray F-125B/F-125C camera specifications

Feature	Specification
Dimensions (L x W x H)	72.9 mm x 44 mm x 29 mm, including connectors (without tripod and lens)
Mass	92 g (without lens) for cameras with S/N ≤ 09/17-285831532 108 g (without lens) for cameras with S/N > 09/17-285831532
Operating temperature	+ 5 °C to + 45 °C ambient temperature (without condensation)
Storage temperature	- 10 °C to + 70 °C ambient temperature (without condensation)
Standard accessories	F-125B: protection glass F-125C: IR cut filter
Optional accessories	F-125B: IR cut filter, IR pass filter F-125C: protection glass
On request	Host adapter card, angled head, power out: 6 W (Hirose)
Software packages	www.alliedvision.com/en/support/software-downloads (free of charge)

Table 10: Stingray F-125B/F-125C camera specifications (continued)

Absolute QE

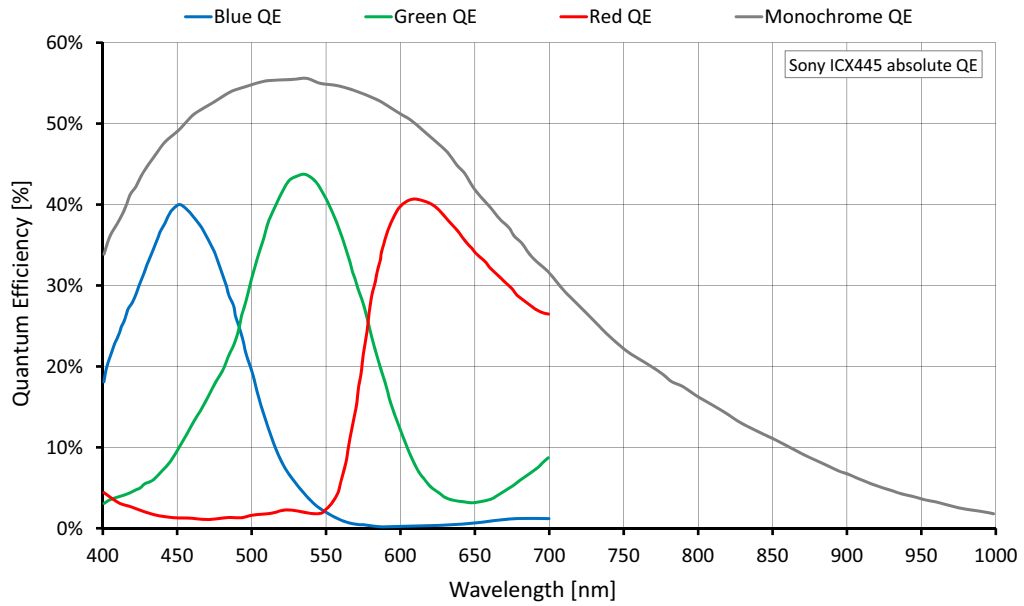

Figure 11: Stingray F-125B/F-125C (Sony ICX445) absolute QE plot

Spectral response

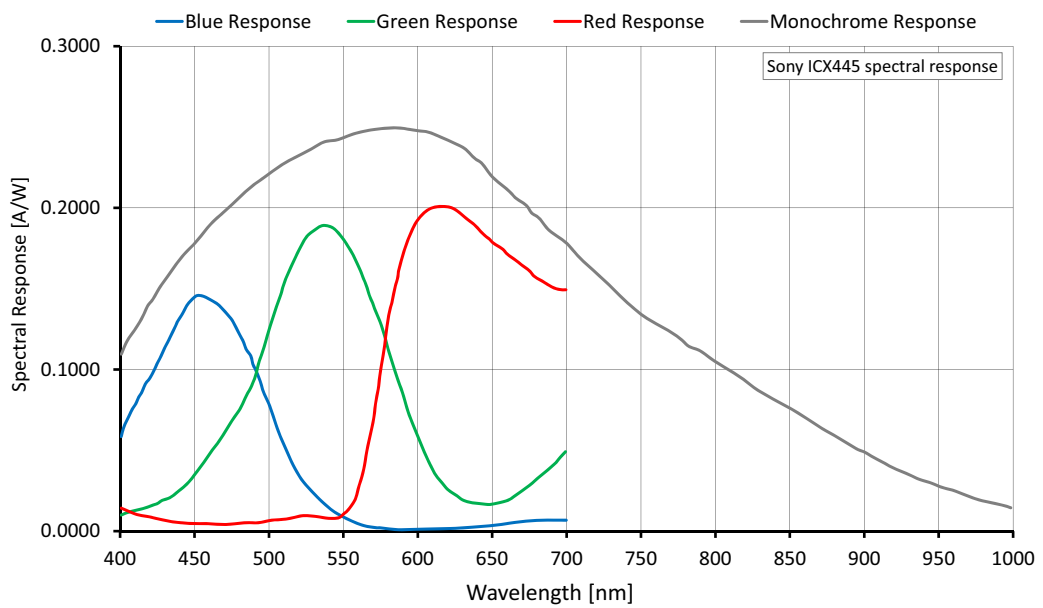

Figure 12: Stingray F-125B/F-125C (Sony ICX445) spectral response plot

Stingray F-145B/F-145C

Feature	Specification
Image device	Sony CCD ICX285AL/AQ with EXview HAD microlens Type 2/3 (diagonal 11 mm) progressive scan
Effective chip size	9.0 mm x 6.7 mm
Cell size	6.45 μm x 6.45 μm
Picture size (maximum)	1388 x 1038 pixels (Format_7 Mode_0)
Lens mount	C-Mount: 17.526 mm (in air); \varnothing 25.4 mm (32 tpi) maximum protrusion: 10.1 mm (see Table 28 on page 93) CS-Mount: 12.526 mm (in air), \varnothing 25.4 mm (32 tpi) maximum protrusion: 5.1 mm (see Table 27 on page 92) Maximum protrusion means the distance from lens flange to the glass filter in the camera.
ADC	14-bit
Color modes (I IDC)	F-145C: Raw8, Raw12, Raw16, Mono8, YUV422, YUV411, RGB8
Frame rates	Up to 30 fps, up to 16 fps in Format_7
Gain control	Manual: 0 to 24.4 dB (0.0359 dB/step); auto gain (select. AOI)
Shutter speed	74 μs to 67 s; auto shutter (select. AOI)
External trigger shutter	Programmable, trigger level control, single trigger, bulk trigger, programmable trigger delay
Image buffer (RAM)	32 MB, up to 10 frames for cameras with S/N 285884416 to 301989887 128 MB, up to 40 frames for cameras with S/N 319438848 to 335544319
Non-volatile memory (Flash)	No user access for cameras with S/N 285884416 to 301989887 User access: 256 KB for cameras with S/N 319438848 to 335544319
Look-up tables	User programmable (12 bit \rightarrow 10 bit); default gamma (0.45)
Smart functions	Auto gain control (AGC), auto exposure control (AEC), real-time shading correction, look-up table (LUT), 32 MB image memory, mirror, binning (F-145B only), sub-sampling, High SNR, deferred image transport, secure image signature (SIS), sequence mode, 4 storable user sets F-145C: auto white balance (AWB), color correction, hue, saturation, sharpness
I/O	Two configurable inputs, four configurable outputs RS232 port (serial port, I IDC V1.31)
Transfer rate	Up to 800 Mb/s
Digital interface	IEEE 1394b (I IDC V1.31), 2 x copper connectors (bilingual) (daisy chain)
Power requirements	8 to 36 VDC via IEEE 1394 cable or 12-pin Hirose
Power consumption	Typical < 3.5 W @ 12 VDC (full resolution and maximal frame rates)

Table 11: Stingray F-145B/F-145C camera specifications

Feature	Specification
Dimensions (L x W x H)	72.9 mm x 44 mm x 29 mm, including connectors, without tripod and lens
Mass	92 g (without lens) for cameras with S/N ≤ 09/17-285831532 108 g (without lens) for cameras with S/N > 09/17-285831532
Operating temperature	+ 5 °C to + 45 °C ambient temperature (without condensation)
Storage temperature	- 10 °C to + 70 °C ambient temperature (without condensation)
Standard accessories	F-145B: protection glass F-145C: IR cut filter
Optional accessories	F-145B: IR cut filter, IR pass filter F-145C: protection glass
On request	Host adapter card, angled head, power out: 6 W (Hirose)
Software packages	www.alliedvision.com/en/support/software-downloads (free of charge)

Table 11: Stingray F-145B/F-145C camera specifications (continued)

Absolute QE

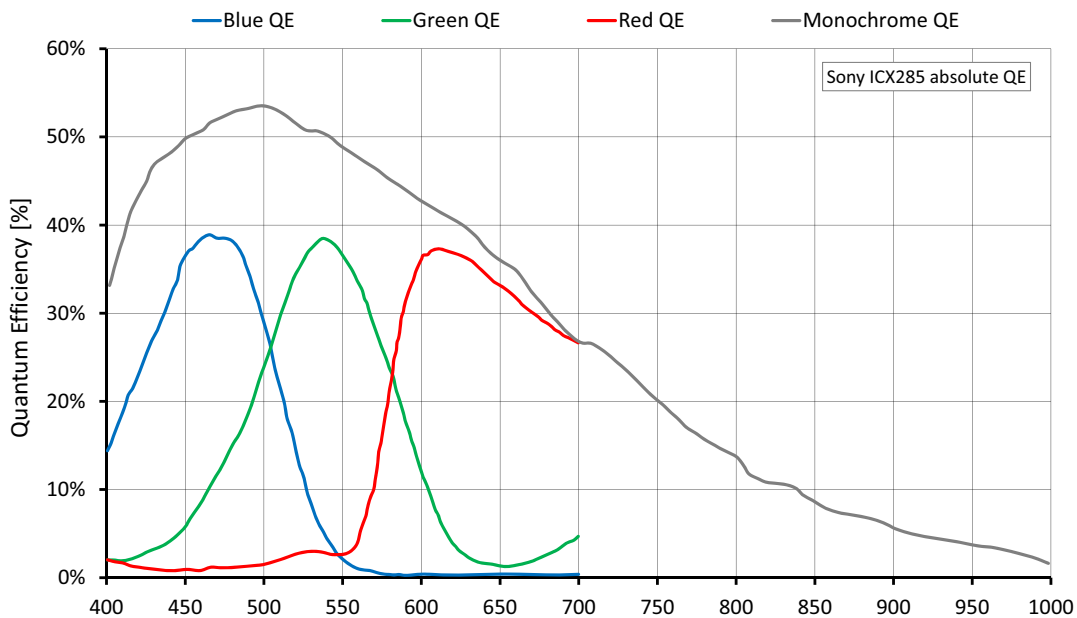

Figure 13: Stingray F-145B/F-145C (Sony ICX285) absolute QE plot

Spectral response

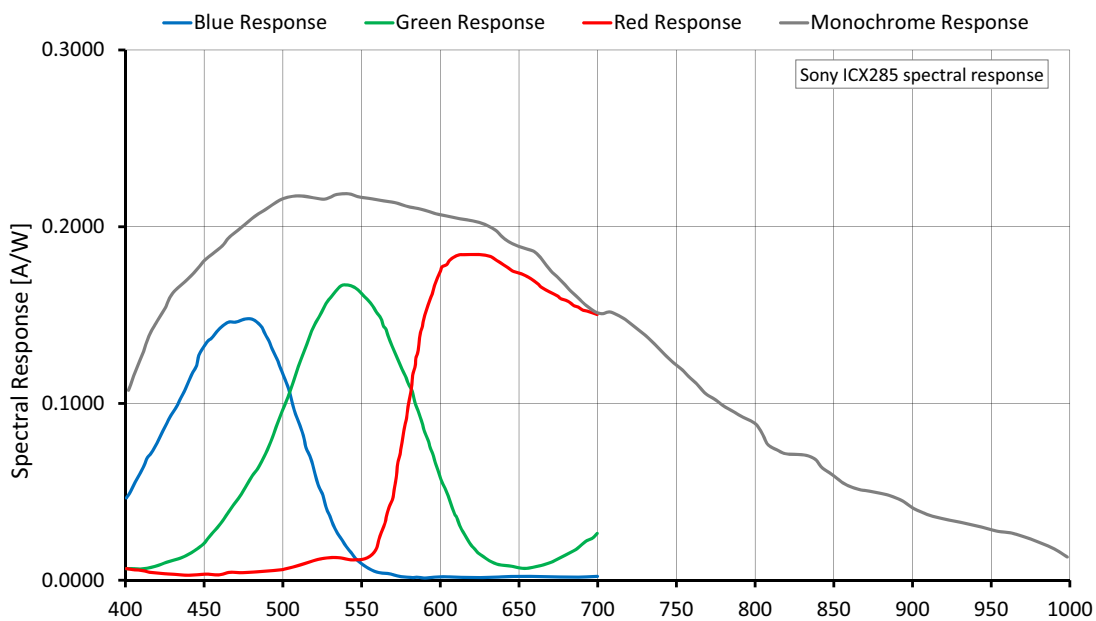

Figure 14: Stingray F-145B/F-145C (Sony ICX285) spectral response plot

Stingray F-146B/F-146C

Feature	Specification
Image device	Sony IT CCD ICX267AL/AK with HAD microlens Type 1/2 (diagonal 8 mm) progressive scan
Effective chip size	6.5 mm x 4.8 mm
Cell size	4.65 μm x 4.65 μm
Picture size (maximum)	1388 x 1038 pixels (Format_7 Mode_0)
Lens mount	C-Mount: 17.526 mm (in air); \varnothing 25.4 mm (32 tpi) maximum protrusion: 10.1 mm (see Table 28 on page 93) CS-Mount: 12.526 mm (in air), \varnothing 25.4 mm (32 tpi) maximum protrusion: 5.1 mm (see Table 27 on page 92) Maximum protrusion means the distance from lens flange to the glass filter in the camera.
ADC	14-bit
Color modes (I IDC)	F-146C: Raw8, Raw12, Raw16, Mono8, YUV422, YUV411, RGB8
Frame rates	Up to 60 fps, up to 15 fps in Format_7
Gain control	Manual: 0 to 24.4 dB (0.0359 dB/step); auto gain (select. AOI)
Shutter speed	39 μs to 67 s; auto shutter (select. AOI)
External trigger shutter	Programmable, trigger level control, single trigger, bulk trigger, programmable trigger delay
Image buffer (RAM)	32 MB, up to 10 frames for cameras with S/N 285884416 to 301989887 128 MB, up to 40 frames for cameras with S/N 319438848 to 335544319
Non-volatile memory (Flash)	No user access for cameras with S/N 285884416 to 301989887 User access: 256 KB for cameras with S/N 319438848 to 335544319
Look-up tables	User programmable (12 bit \rightarrow 10 bit); default gamma (0.45)
Smart functions	Auto gain control (AGC), auto exposure control (AEC), real-time shading correction, look-up table (LUT), 32 MB image memory, mirror, binning (F-146B only), sub-sampling, High SNR, deferred image transport, secure image signature (SIS), sequence mode, 4 storable user sets F-146C: auto white balance (AWB), color correction, hue, saturation, sharpness
I/O	Two configurable inputs, four configurable outputs RS232 port (serial port, I IDC V1.31)
Transfer rate	Up to 800 Mb/s
Digital interface	IEEE 1394b (I IDC V1.31), 2 x copper connectors (bilingual) (daisy chain)
Power requirements	8 to 36 VDC via IEEE 1394 cable or 12-pin Hirose
Power consumption	Typical < 3.5 W @ 12 VDC (full resolution and maximal frame rates)

Table 12: Stingray F-146B/F-146C camera specifications

Feature	Specification
Dimensions (L x W x H)	72.9 mm x 44 mm x 29 mm, including connectors (without tripod and lens)
Mass	92 g (without lens) for cameras with S/N ≤ 09/17-285831532 108 g (without lens) for cameras with S/N > 09/17-285831532
Operating temperature	+ 5 °C to + 45 °C ambient temperature (without condensation)
Storage temperature	- 10 °C to + 70 °C ambient temperature (without condensation)
Standard accessories	F-146B: protection glass F-146C: IR cut filter
Accessories	F-146B: IR cut filter, IR pass filter F-146C: protection glass
On request	Host adapter card, angled head, power out: 6 W (Hirose)
Software packages	www.alliedvision.com/en/support/software-downloads (free of charge)

Table 12: Stingray F-146B/F-146C camera specifications (continued)

Absolute QE

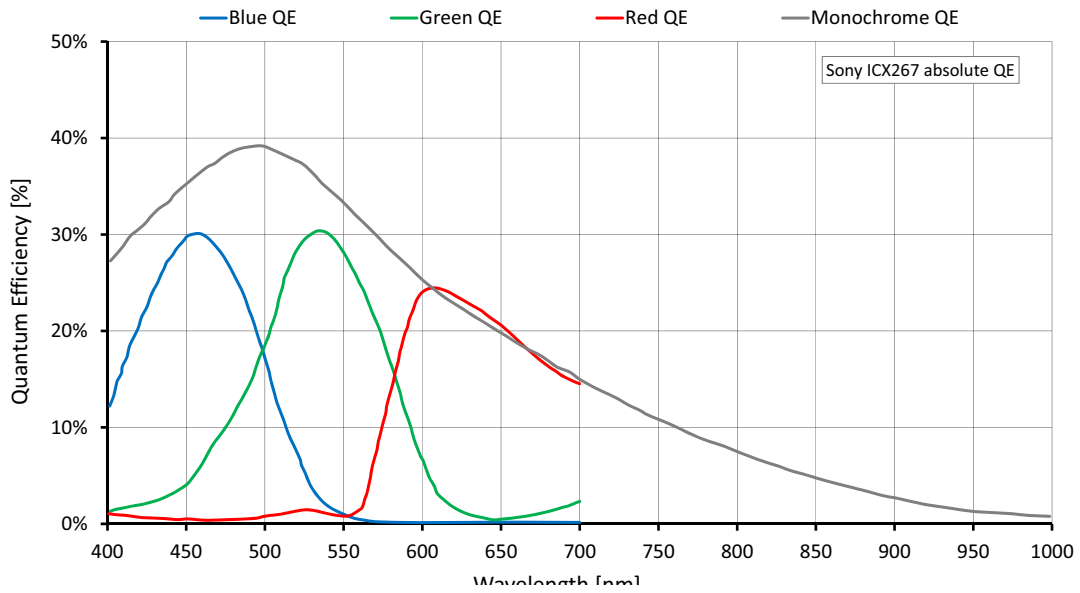

Figure 15: Stingray F-146B/F-146C (Sony ICX267) absolute QE plot

Spectral response

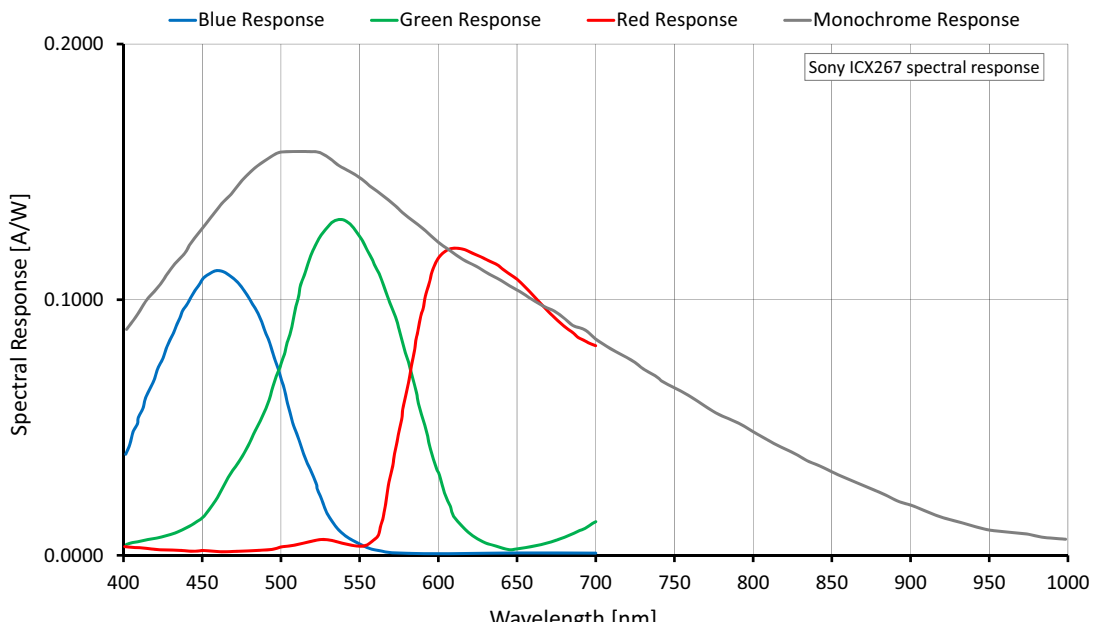

Figure 16: Stingray F-146B/F-146C (Sony ICX267) spectral response plot

Stingray F-201B/F-201C

Feature	Specification
Image device	Sony CD ICX274AL/AQ with Super HAD microlens Type 1/1.8 (diagonal 8.9 mm) progressive scan
Effective chip size	7.1 mm x 5.4 mm
Cell size	4.40 μm x 4.40 μm
Picture size (maximum)	1624 x 1234 pixels (Format_7 Mode_0)
Lens mount	C-Mount: 17.526 mm (in air); \varnothing 25.4 mm (32 tpi) maximum protrusion: 10.1 mm (see Table 28 on page 93) CS-Mount: 12.526 mm (in air), \varnothing 25.4 mm (32 tpi) maximum protrusion: 5.1 mm (see Table 27 on page 92) Maximum protrusion means the distance from lens flange to the glass filter in the camera.
ADC	14-bit
Color modes (I IDC)	F-201C: Raw8, Raw12, Raw16, Mono8, YUV422, YUV411, RGB8
Frame rates	Up to 60 fps, up to 14 fps in Format_7
Gain control	Manual: 0 to 24.4 dB (0.0359 dB/step); auto gain (select. AOI)
Shutter speed	48 μs to 67 s; auto shutter (select. AOI)
External trigger shutter	Programmable, trigger level control, single trigger, bulk trigger, programmable trigger delay
Image buffer (RAM)	32 MB, up to 7 frames for cameras with S/N 285884416 to 301989887 128 MB, up to 28 frames for cameras with S/N 319438848 to 335544319
Non-volatile memory (Flash)	No user access for cameras with S/N 285884416 to 301989887 User access: 256 KB for cameras with S/N 319438848 to 335544319
Look-up tables	User programmable (12 bit \rightarrow 10 bit); default gamma (0.45)
Smart functions	Auto gain control (AGC), auto exposure control (AEC), real-time shading correction, look-up table (LUT), 32 MB image memory, mirror, binning, sub-sampling, High SNR, deferred image transport, secure image signature (SIS), sequence mode, 4 storable user sets F-201C: auto white balance (AWB), color correction, hue, saturation, sharpness
I/O	Two configurable inputs, four configurable outputs RS232 port (serial port, I IDC V1.31)
Transfer rate	Up to 800 Mb/s
Digital interface	IEEE 1394b (I IDC V1.31), 2 x copper connectors (bilingual) (daisy chain)
Power requirements	8 to 36 VDC via IEEE 1394 cable or 12-pin Hirose
Power consumption	Typical < 3.5 W @ 12 VDC (full resolution and maximal frame rates)

Table 13: Stingray F-201B/F-201C camera specifications

Feature	Specification
Dimensions (L x W x H)	72.9 mm x 44 mm x 29 mm, including connectors (without tripod and lens)
Mass	92 g (without lens) for cameras with S/N ≤ 09/17-285831532 108 g (without lens) for cameras with S/N > 09/17-285831532
Operating temperature	+ 5 °C to + 45 °C ambient temperature (without condensation)
Storage temperature	- 10 °C to + 70 °C ambient temperature (without condensation)
Standard accessories	F-201B: protection glass F-201C: IR cut filter
Optional accessories	F-201B: IR cut filter, IR pass filter F-201C: protection glass
On request	Host adapter card, angled head, power out: 6 W (Hirose)
Software packages	www.alliedvision.com/en/support/software-downloads (free of charge)

Table 13: Stingray F-201B/F-201C camera specifications (continued)

Absolute QE

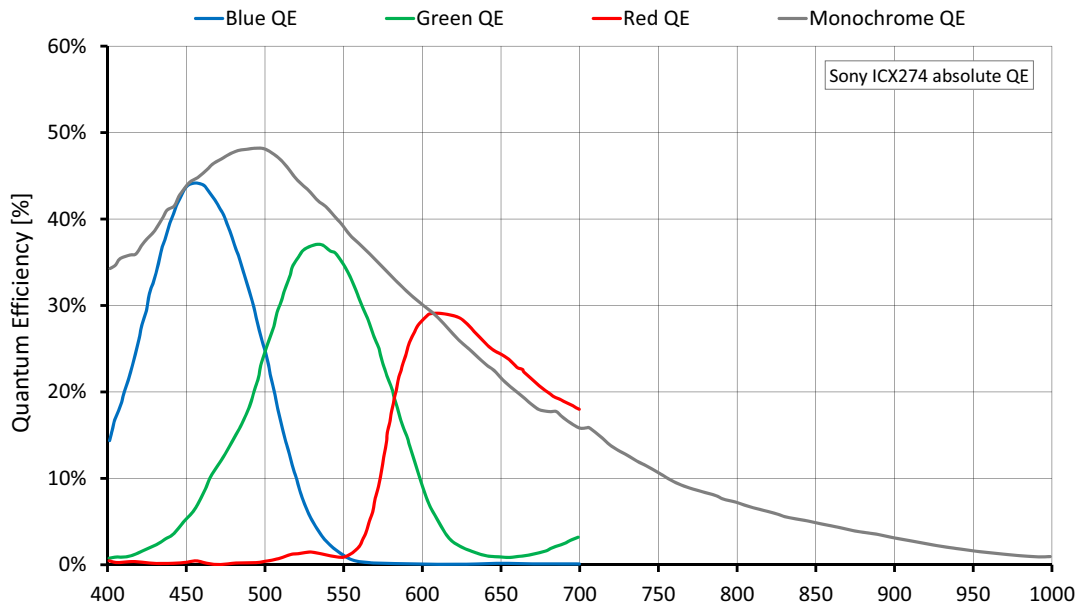

Figure 17: Stingray F-201B/F-201C (Sony ICX274) absolute QE plot

Spectral response

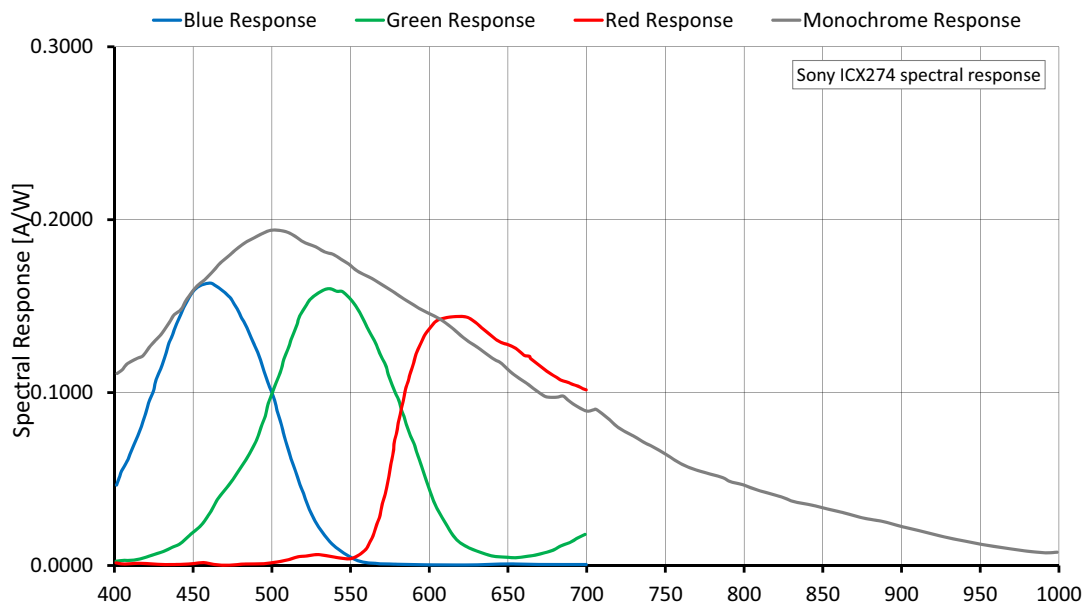

Figure 18: Stingray F-201B/F-201C (Sony ICX274) spectral response plot

Stingray F-504B/F-504C

Feature	Specification
Image device	Sony CCD ICX655ALA/AQA with Super HAD microlens Type 2/3 (diagonal 11 mm) progressive scan
Effective chip size	8.5 mm x 7.1 mm
Cell size	3.45 μm x 3.45 μm
Picture size (maximum)	2452 x 2056 pixels (Format_7 Mode_0)
Lens mount	C-Mount: 17.526 mm (in air); \varnothing 25.4 mm (32 tpi) maximum protrusion: 10.1 mm (see Table 28 on page 93) CS-Mount: 12.526 mm (in air), \varnothing 25.4 mm (32 tpi) maximum protrusion: 5.1 mm (see Table 27 on page 92) Maximum protrusion means the distance from lens flange to the glass filter in the camera.
ADC	14-bit
Color modes (I IDC)	F-504C: Raw8, Raw12, Raw16, Mono8, YUV422, YUV411, RGB8
Frame rates	Up to 15 fps, up to 9 fps in Format_7
Gain control	Manual: 0 to 24.053 dB (0.0359 dB/step); auto gain (select. AOI)
Shutter speed	42 μs to 67 s; auto shutter (select. AOI)
External trigger shutter	Programmable, trigger level control, single trigger, bulk trigger, programmable trigger delay
Image buffer (RAM)	54 MB, up to 12 frames for cameras with S/N 285884416 to 301989887 128 MB, up to 20 frames for cameras with S/N 319438848 to 335544319
Non-volatile memory (Flash)	No user access for cameras with S/N 285884416 to 301989887 User access: 256 KB for cameras with S/N 319438848 to 335544319
Look-up tables	User programmable (12 bit \rightarrow 10 bit); default gamma (0.45)
Smart functions	Auto gain control (AGC), auto exposure control (AEC), real-time shading correction, look-up table (LUT), 64 MB image memory, mirror, binning, sub-sampling, High SNR, deferred image transport, secure image signature (SIS), sequence mode, 4 storable user sets F-504C: auto white balance (AWB), color correction, hue, saturation, sharpness
I/O	Two configurable inputs, four configurable outputs RS232 port (serial port, I IDC V1.31)
Transfer rate	Up to 800 Mb/s
Digital interface	IEEE 1394b (I IDC V1.31), 2 x copper connectors (bilingual) (daisy chain)
Power requirements	8 to 36 VDC via IEEE 1394 cable or 12-pin Hirose
Power consumption	Typical < 3.9 W @ 12 VDC (full resolution and maximal frame rates)

Table 14: Stingray F-504B/F-504C camera specifications

Feature	Specification
Dimensions (L x W x H)	72.9 mm x 44 mm x 29 mm, including connectors, without tripod and lens
Mass	92 g (without lens) for cameras with S/N ≤ 09/17-285831532 108 g (without lens) for cameras with S/N > 09/17-285831532
Operating temperature	+ 5 °C to + 45 °C ambient temperature (without condensation)
Storage temperature	- 10 °C to + 70 °C ambient temperature (without condensation)
Standard accessories	F-504B: protection glass F-504C: IR cut filter
Optional accessories	F-504B: IR cut filter, IR pass filter F-504C: protection glass
On request	Host adapter card, angled head, power out: 6 W (Hirose)
Software packages	www.alliedvision.com/en/support/software-downloads (free of charge)

Table 14: Stingray F-504B/F-504C camera specifications (continued)

Absolute QE

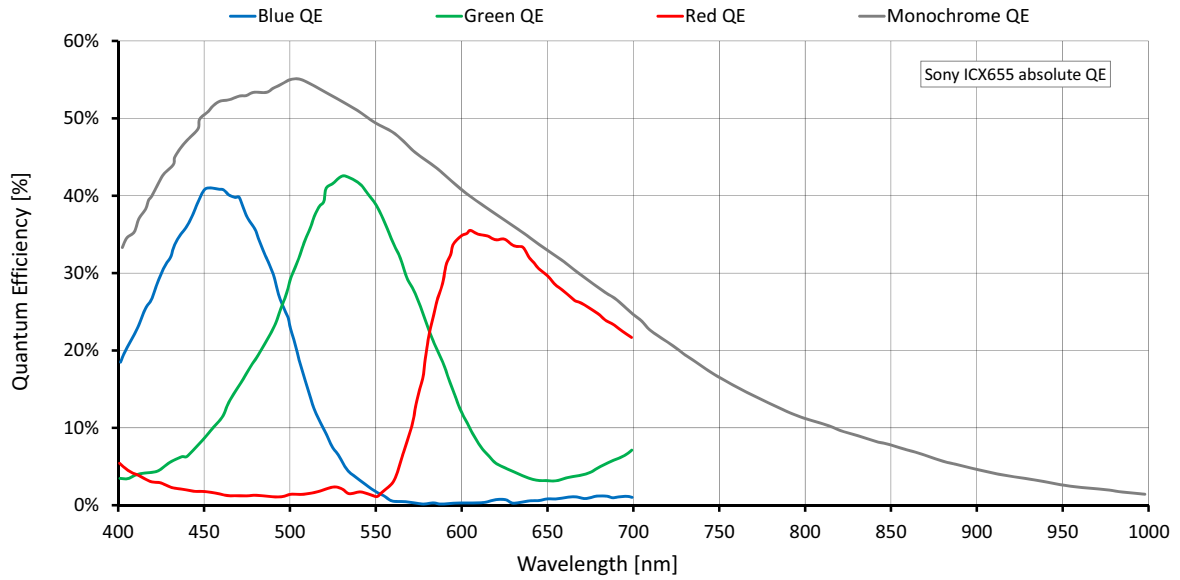

Figure 19: Stingray F-504B/F-504C (Sony ICX655) absolute QE plot

Spectral response

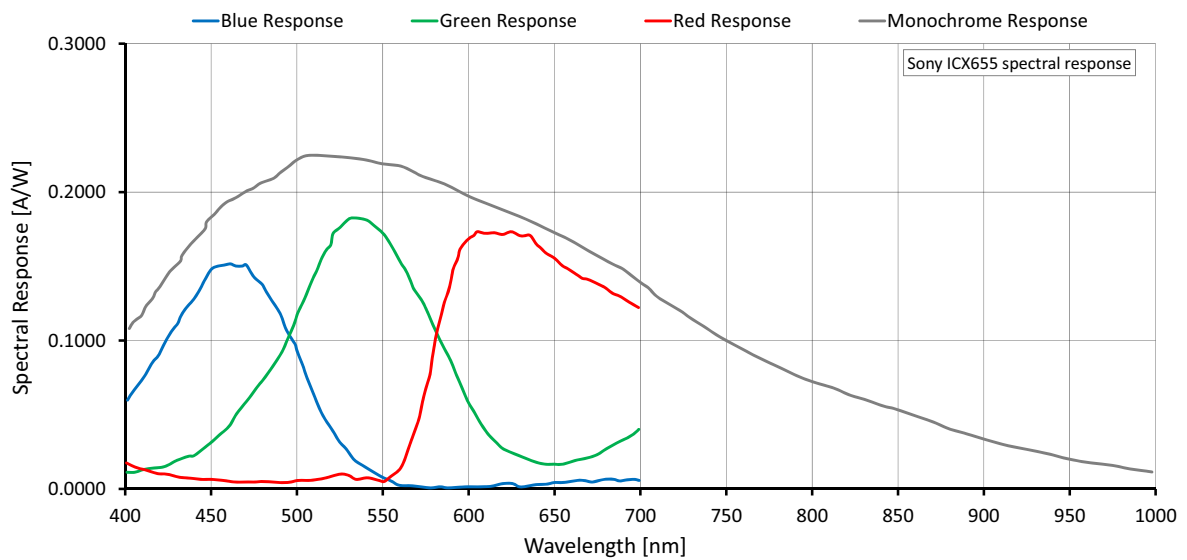

Figure 20: Stingray F-504B/F-504C (Sony ICX655) spectral response plot

Camera dimensions

Note

For information on **sensor position accuracy:**

(sensor shift x/y , optical back focal length z and sensor rotation α) see chapter [Sensor position accuracy of Stingray cameras](#) on page 336.

Serial numbers for starting new front flange

Camera model	Order code	Serial number
Stingray F-046B ASG	E0010003	SN: 09/17-285843839
Stingray F-046C IRF	E0010004	SN: 09/17-285843873
Stingray F-125C IRF	E0010063	SN: 09/17-285843866
Stingray F-201B ASG	E0010007	SN: 09/17-285843801
Stingray F-201C IRF	E0010008	SN: 09/17-285843904

Table 15: Starting serial numbers for new front flange

Stingray standard housing (2 x IEEE 1394b copper)

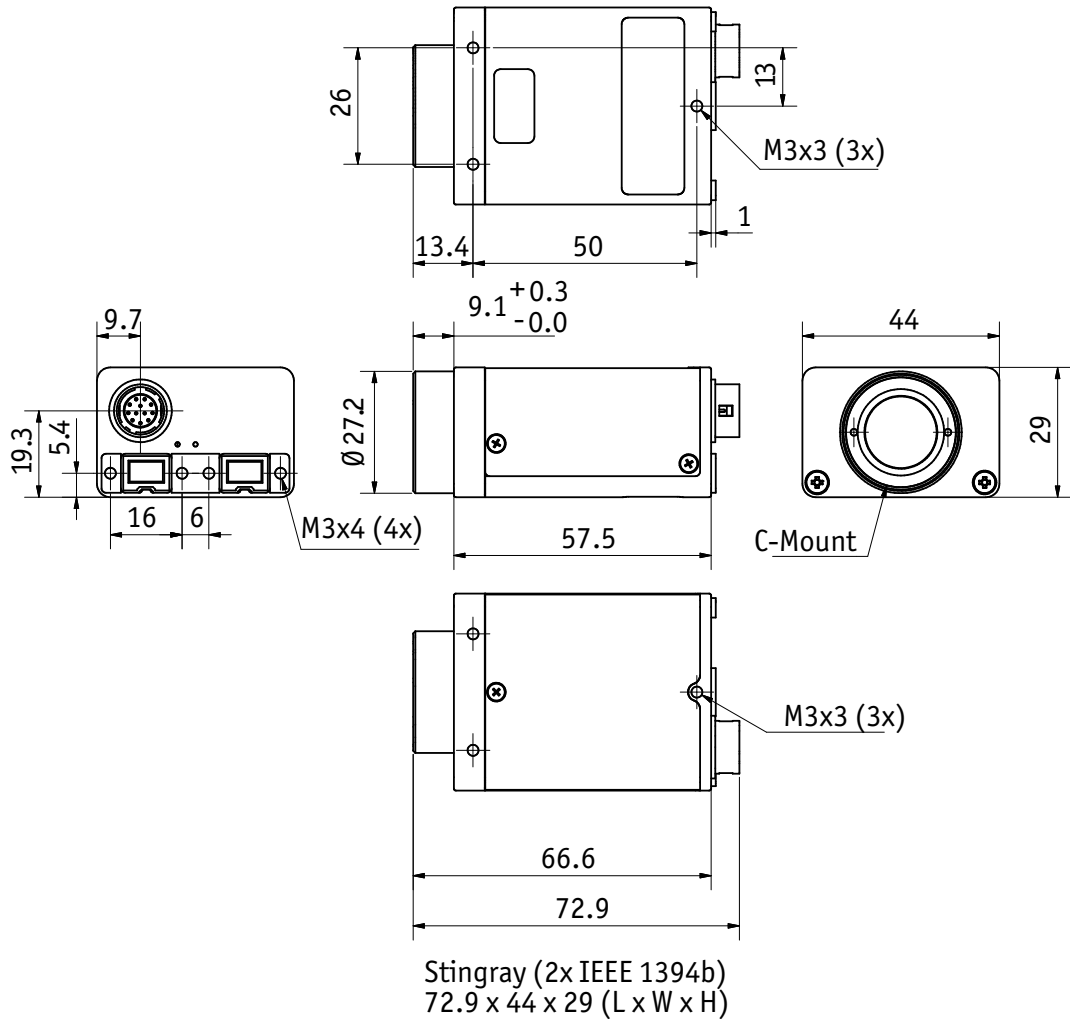

Figure 21: Camera dimensions (2 x IEEE 1394b copper)

Tripod adapter

This five hole tripod adapter (Order number E5000007):

- can be used for Stingray as well as for Marlin. The original four hole adapter of the Marlin should not be used with Stingray.
- is only designed for standard housings, but not for the angled head versions.

Note

If you need a tripod adapter for angled head versions, please contact Allied Vision support.

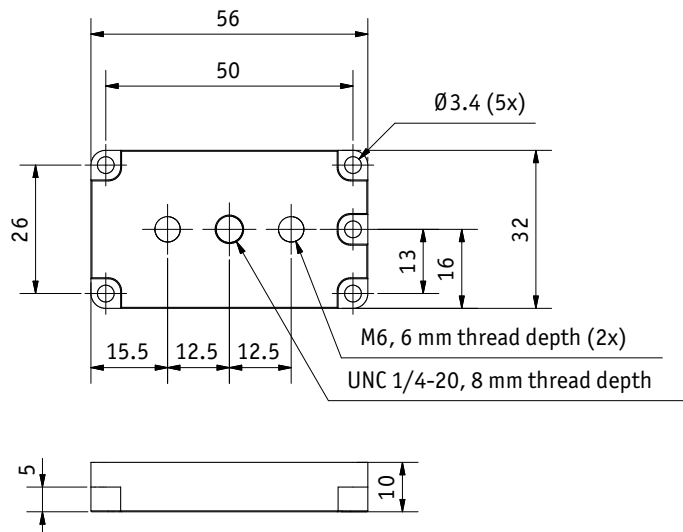

Body size: 56 mm x 32 mm x 10 mm (L x W x H)

Figure 22: Tripod dimensions

Stingray W90 (2 x IEEE 1394b copper)

This version has the sensor tilted by 90 degrees clockwise, so that it views upwards.

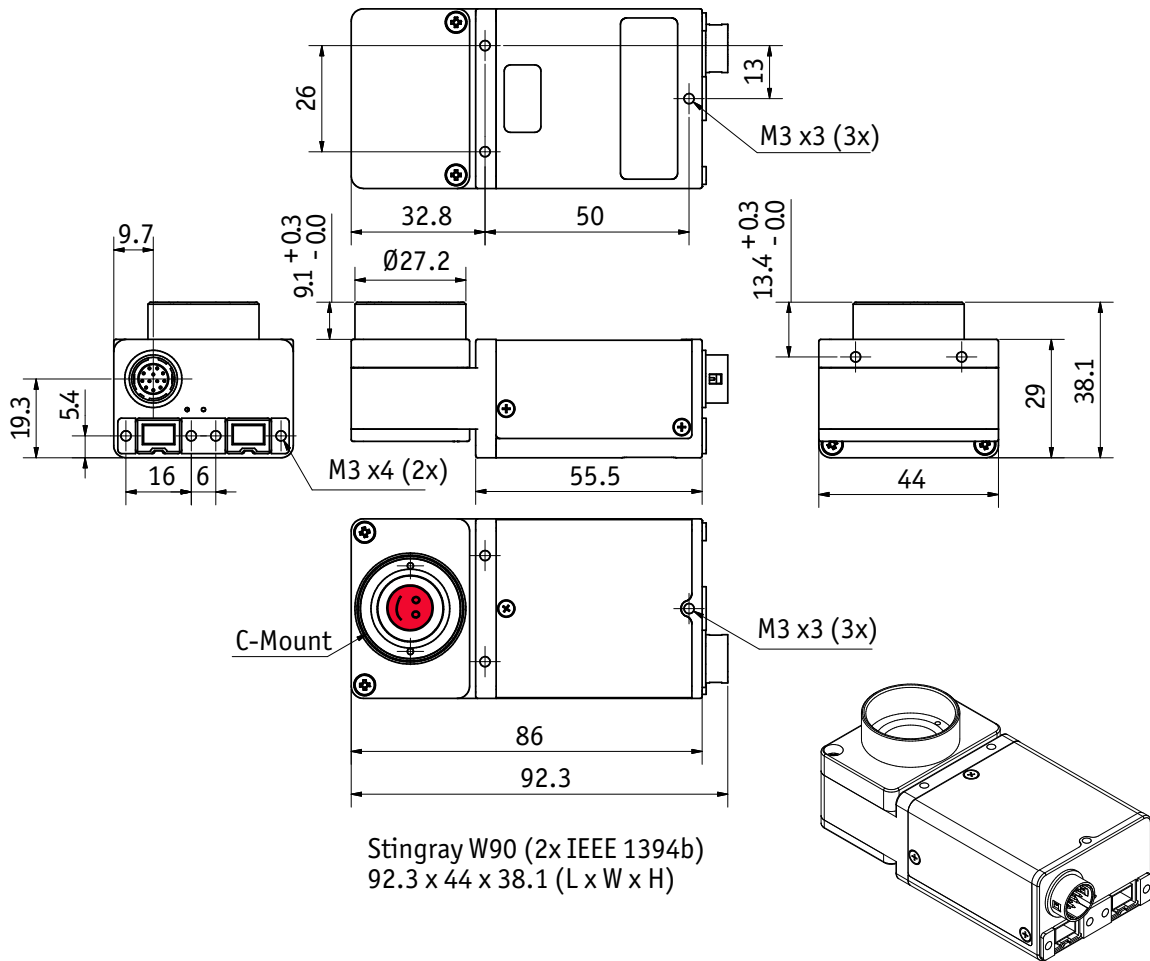

Figure 23: Stingray W90 (2 x IEEE 1394b copper)

Stingray W90 S90 (2 x IEEE 1394b copper)

This version has the sensor tilted by 90 degrees clockwise, so that it views upwards.

The sensor is also rotated by 90 degrees clockwise.

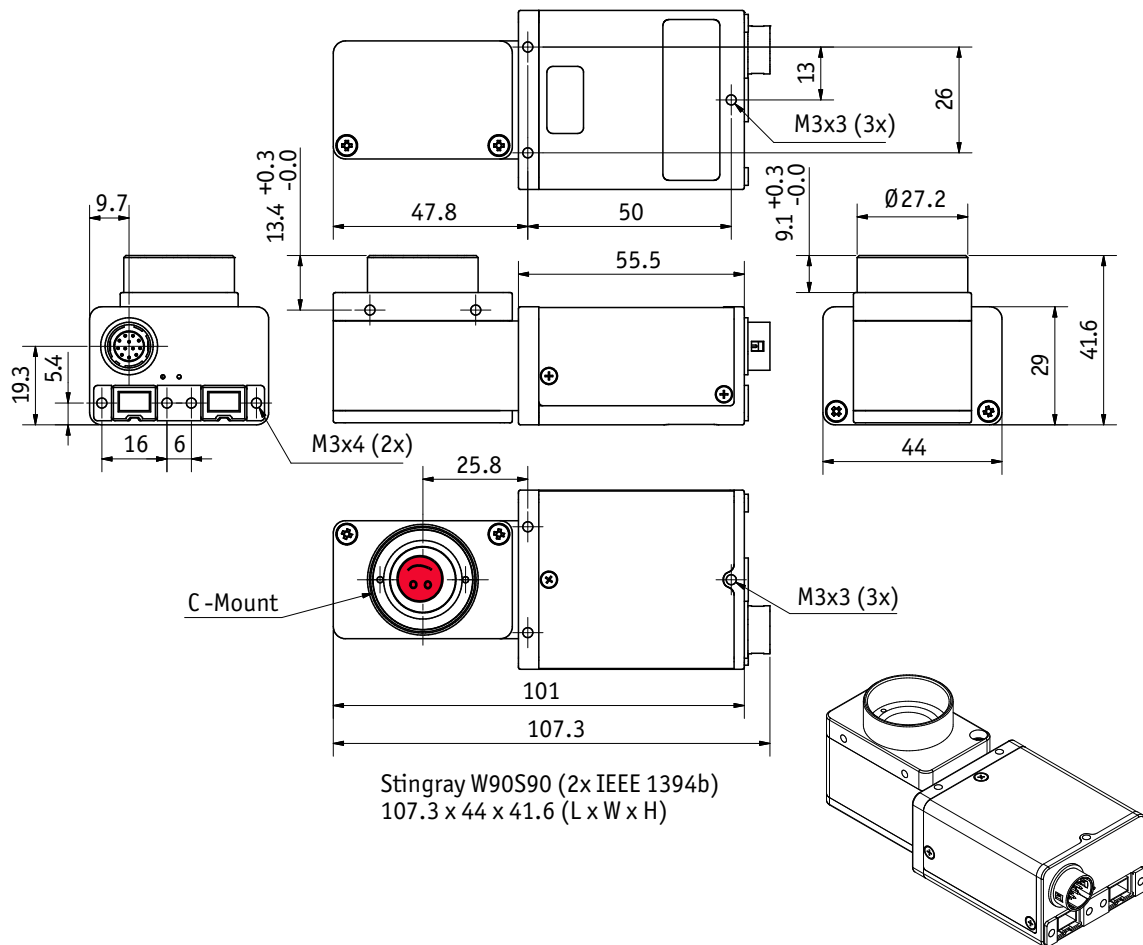

Figure 24: Stingray W90 S90 (2 x IEEE 1394b copper)

Stingray W270 (2 x IEEE 1394b copper)

This version has the sensor tilted by 270 degrees clockwise, so that it views downwards.

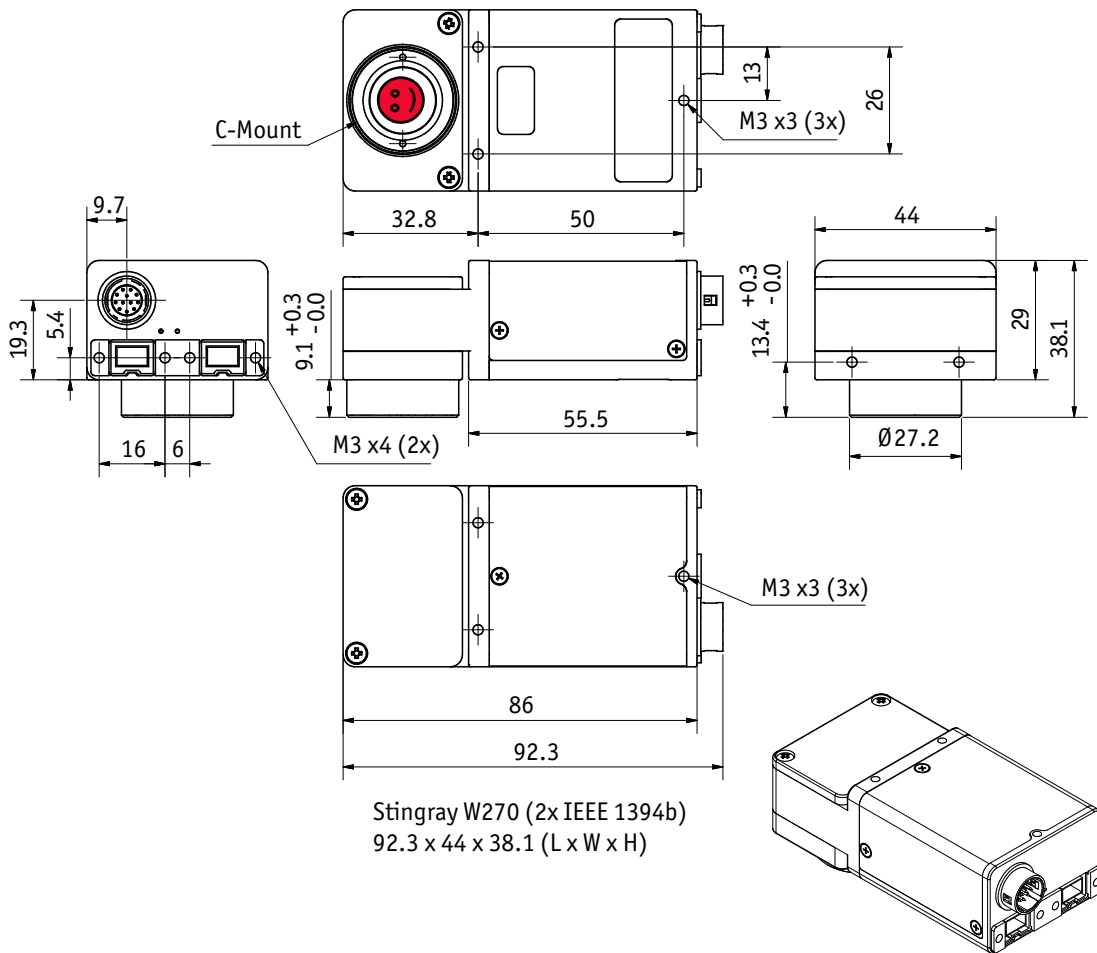

Figure 25: Stingray W270 (2 x IEEE 1394b copper)

Stingray W270 S90 (2 x IEEE 1394b copper)

This version has the sensor tilted by 270 degrees clockwise, so that it views downwards.

The sensor is also rotated by 90 degrees clockwise.

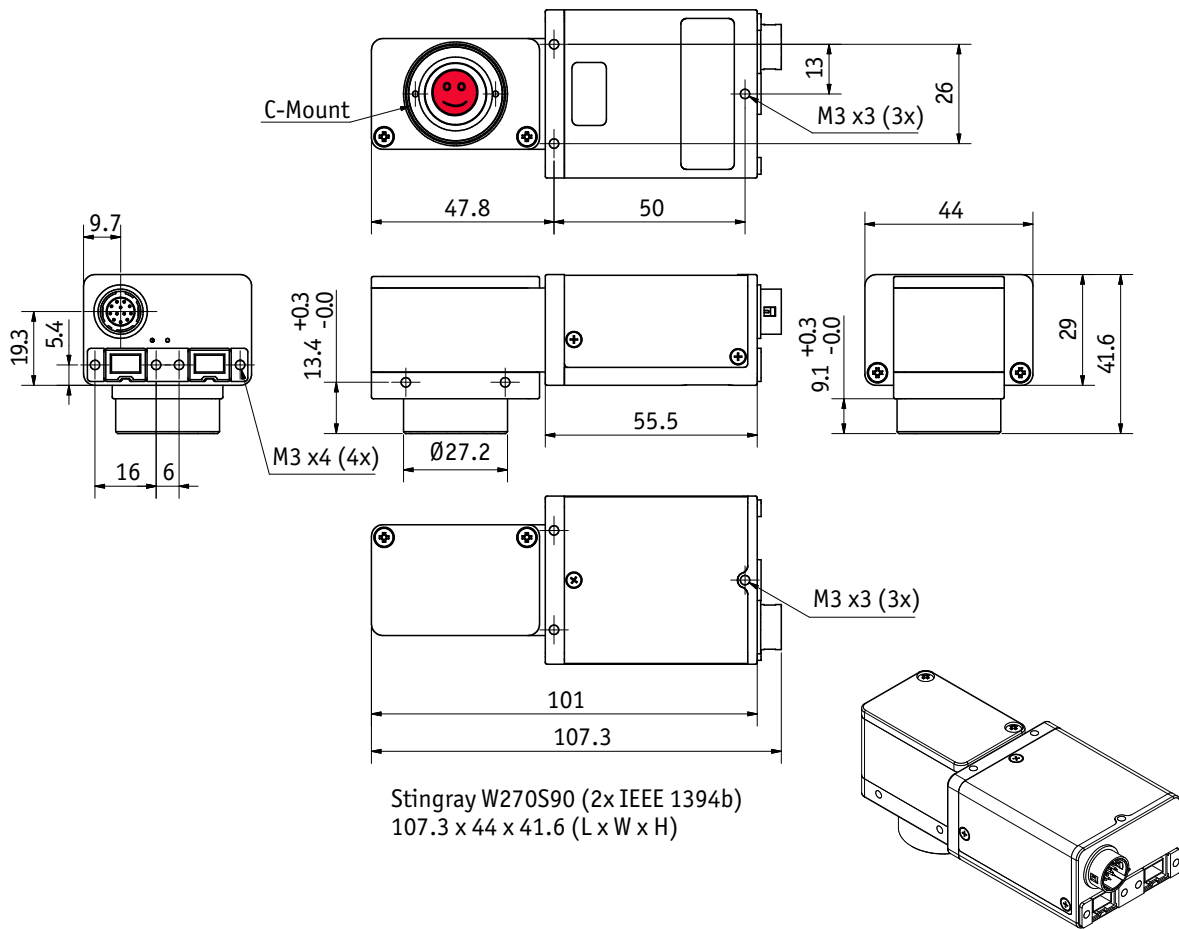

Figure 26: Stingray W270 S90 (2 x IEEE 1394b copper)

Cross section: CS-Mount

All Stingray cameras can be delivered with CS-Mount.

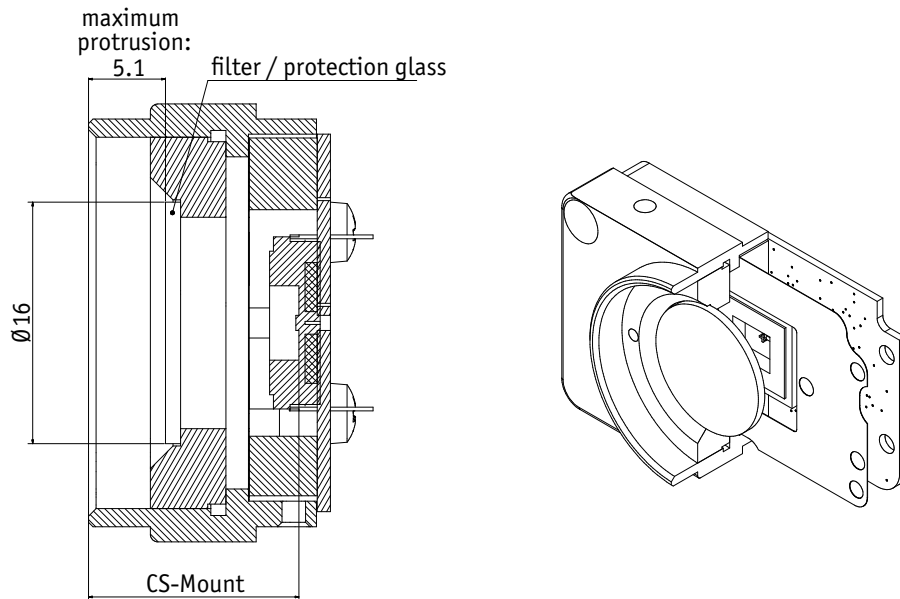

Figure 27: Stingray CS-Mount dimension

Note

Pay attention to the maximum sensor size of the applied CS-Mount lens.



For mount options see the **Modular Concept** at www.alliedvision.com/en/support/technical-documentation

Cross section: C-Mount

- All monochrome Stingrays are equipped with the same model of protection glass.
- All color Stingrays are equipped with the same model of IR cut filter.

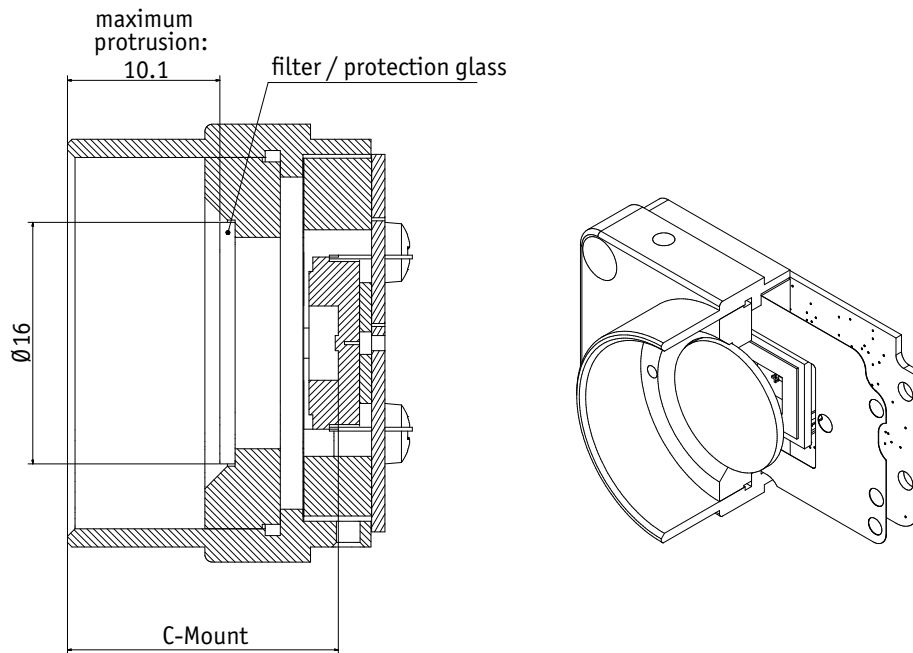

Figure 28: Stingray C-Mount dimensions

Adjustment of C-Mount and CS-Mount

Note



The dimensional adjustment cannot be done any more by the customer. All **modifications** have to be done by the Allied Vision factory.

If you need any modifications, please contact Allied Vision support: For phone numbers and email: See chapter [Contact us](#) on page 15.

Stingray board level: dimensions

13-pole I/O connector:
 [Molex 1.25mm Pitch PicoBlade Wire-to-Board Header (53047-1310)]

- | | |
|---|--|
| 1 = GND (for RS232, Ext PWR) | 7 = GND (for Inputs) |
| 2 = Ext PWR input
(PWR output on demand) | 8 = RxD 9 = TxD |
| 3 = Output 4 | 10 = Power Input
(for Output ports) |
| 4 = Input 1 | 11 = Input 2 |
| 5 = Output 3 | 12 = Output 2 |
| 6 = Output 1 | 13 = Cable Shield |

FFC45 cable length:

- FFC45 L = 56 mm K7500307
 FFC45 L = 110 mm K7500318

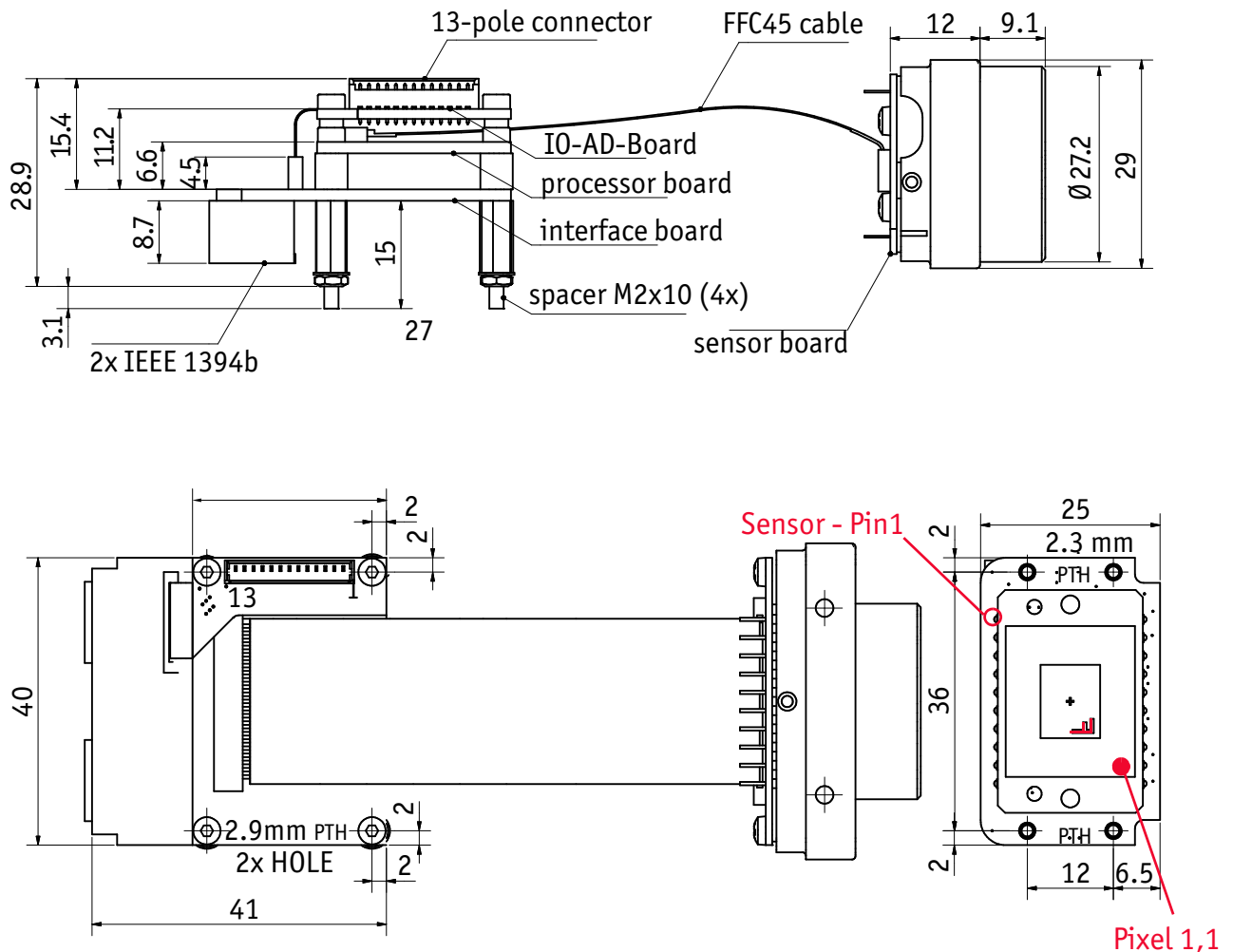

Figure 29: Stingray board level dimensions

Stingray board level: CS-Mount

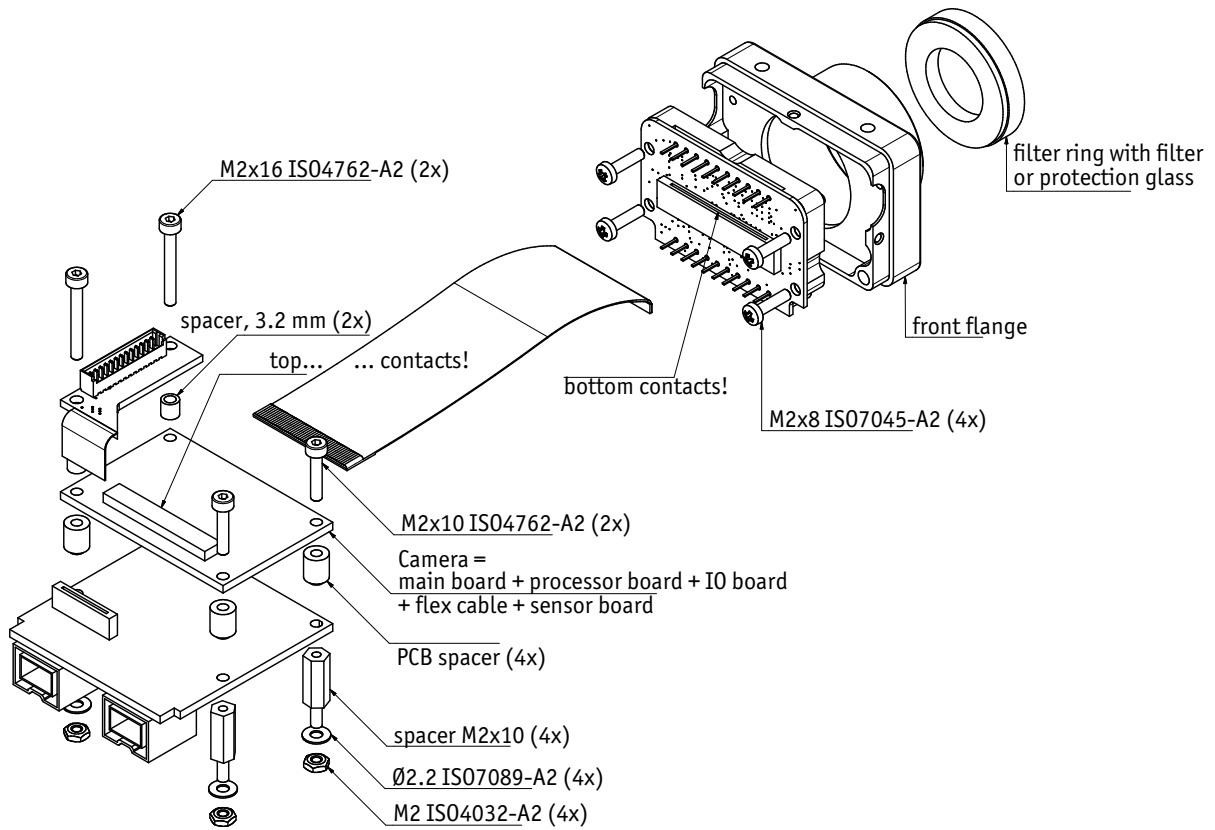

Figure 30: Stingray board level: CS-Mount

Stingray board level: C-Mount

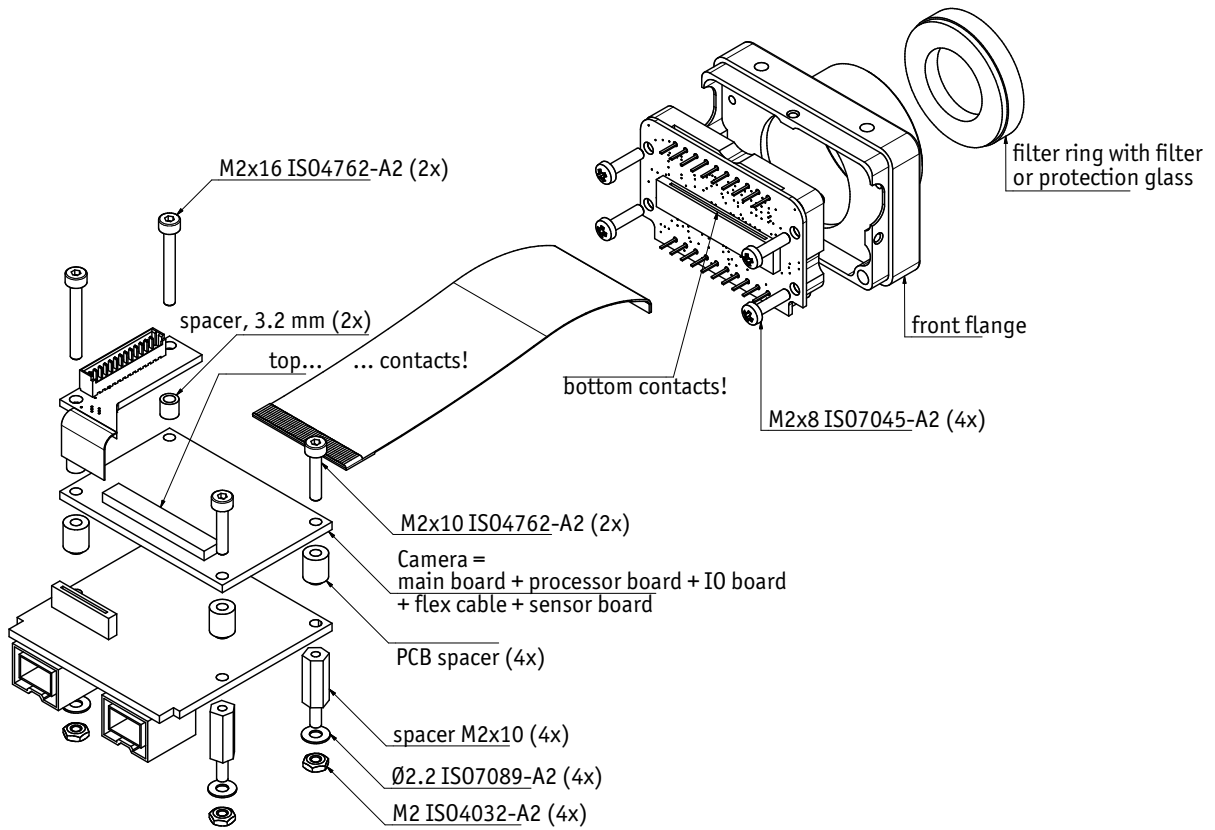

Figure 31: Stingray board level: C-Mount

Filter and lenses

IR cut filter: spectral transmission

Only Stingray color cameras have a built-in IR cut filter.

The following illustration shows the spectral transmission of the IR cut filter:

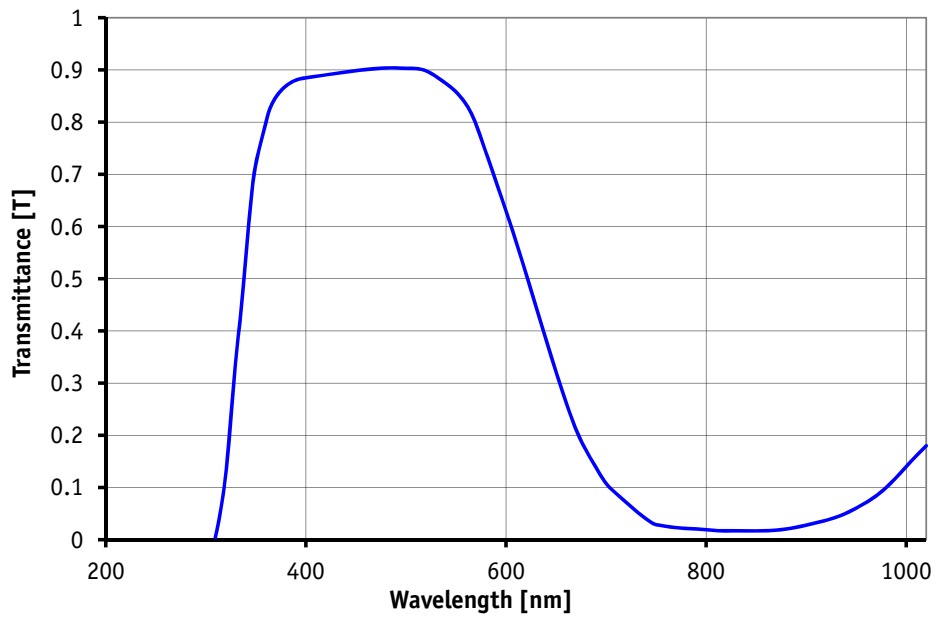

Figure 32: Typical spectral transmission of IR cut filter type Hoya C5000 (exemplary curve, values may vary slightly by filter lot)

Camera lenses

Allied Vision offers different lenses from a variety of manufacturers. The following table lists selected image formats in **width x height** depending on camera type, distance, and focal length of the lens.

Stingray F-080, F-125

Focal length for type 1/3 sensors	Distance = 500 mm	Distance = 1000 mm
4.8 mm	495 x 371 mm	995 x 746 mm
8 mm	295 x 221 mm	595 x 446 mm
12 mm	195 x 146 mm	395 x 296 mm
16 mm	145 x 109 mm	295 x 221 mm
25 mm	91 x 68 mm	187 x 140 mm
35 mm	64 x 48 mm	132 x 99 mm
50 mm	43 x 32 mm	91 x 68 mm

Table 16: Focal length vs. field of view (Stingray F-080, F-125)

Stingray F-033, F-046, F-146

Focal length for type 1/2 sensors	Distance = 500 mm	Distance = 1000 mm
4.8 mm	660 x 495 mm	1327 x 995 mm
8 mm	394 x 295 mm	794 x 595 mm
12 mm	260 x 195 mm	527 x 395 mm
16 mm	194 x 145 mm	394 x 295 mm
25 mm	122 x 91 mm	250 x 187 mm
35 mm	85 x 64 mm	176 x 132 mm
50 mm	58 x 43 mm	122 x 91 mm

Table 17: Focal length vs. field of view (Stingray F-033, F-046, F-146)

Stingray F-201

Focal length for type 1/1.8 sensors	Distance = 500 mm	Distance = 1000 mm
4.8 mm	740 x 549 mm	1488 x 1103 mm
8 mm	441 x 327 mm	890 x 660 mm
12 mm	292 x 216 mm	591 x 438 mm
16 mm	217 x 161 mm	441 x 327 mm
25 mm	136 x 101 mm	280 x 207 mm
35 mm	95 x 71 mm	198 x 147 mm
50 mm	65 x 48 mm	136 x 101 mm

Table 18: Focal length vs. field of view (Stingray F-201)

Stingray F-145, F-504

Focal length for type 2/3 sensors	Distance = 500 mm	Distance = 1000 mm
4.8 mm	908 x 681 mm	1825 x 1368 mm
8 mm	541 x 406 mm	1091 x 818 mm
12 mm	358 x 268 mm	725 x 543 mm
16 mm	266 x 200 mm	541 x 406 mm
25 mm	167 x 125 mm	343 x 257 mm
35 mm	117 x 88 mm	243 x 182 mm
50 mm	79 x 59 mm	167 x 125 mm

Table 19: Focal length vs. field of view (Stingray F-145, F-504)

Note



Lenses with focal lengths < 8 mm may show shading in the edges of the image and due to micro lenses on the sensor's pixel.

Ask your Allied Vision distributor if you require non C-Mount lenses.

Camera interfaces

This chapter gives you detailed information on status LEDs, inputs and outputs, trigger features, and transmission of data packets.

Note



For a detailed description of the camera interfaces (FireWire, I/O connector), ordering numbers, and operating instructions see the 1394 Installation Manual, chapter *Camera interfaces*.

Read all the Notes and Cautions in the **1394 Installation Manual**, before using any interfaces.

IEEE 1394b port pin assignment

The IEEE 1394b connector is designed for industrial use and has the following pin assignment as per specification:

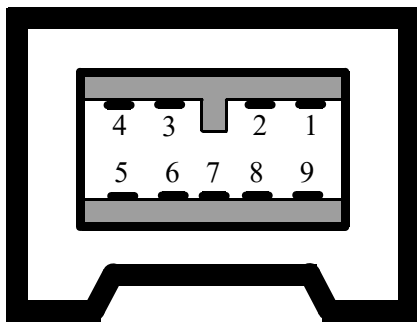

Pin	Signal
1	TPB-
2	TPB+
3	TPA-
4	TPA+
5	TPA (Reference ground)
6	VG (GND)
7	N.C.
8	VP (Power, VCC)
9	TPB (Reference ground)

Figure 33: IEEE 1394b connector

Note



- Both IEEE1394b screw-lock connectors connect to the IEEE1394 bus to control the camera and output frames. Connect the camera with connector. The other connector can be used to daisy chain a second camera.
- Cables with latching connectors on one or both sides can be available with 5 m or 7.5 m length. Contact your Allied Vision distributor for details.

www



For more information on cables and on ordering cables online (by clicking the article and sending an inquiry) go to:
www.alliedvision.com/en/about-us/contact-us

Board level camera: IEEE 1394b port pin assignment

Board level Stingray cameras have two IEEE 1394b ports to allow daisy chaining of cameras. Pin assignment is the same as for Stingray housing cameras.

13-pole I/O connector:
[Molex 1.25mm Pitch PicoBlade Wire-to-Board Header (53047-1310)]

- | | |
|---|--|
| 1 = GND (for RS232, Ext PWR) | 7 = GND (for Inputs) |
| 2 = Ext PWR input
(PWR output on demand) | 8 = Rx/D 9 = Tx/D |
| 3 = Output 4 | 10 = Power Input
(for Output ports) |
| 4 = Input 1 | 11 = Input 2 |
| 5 = Output 3 | 12 = Output 2 |
| 6 = Output 1 | 13 = Cable Shield |

FFC45 cable length:

- FFC45 L = 56 mm K7500307
FFC45 L = 110 mm K7500318

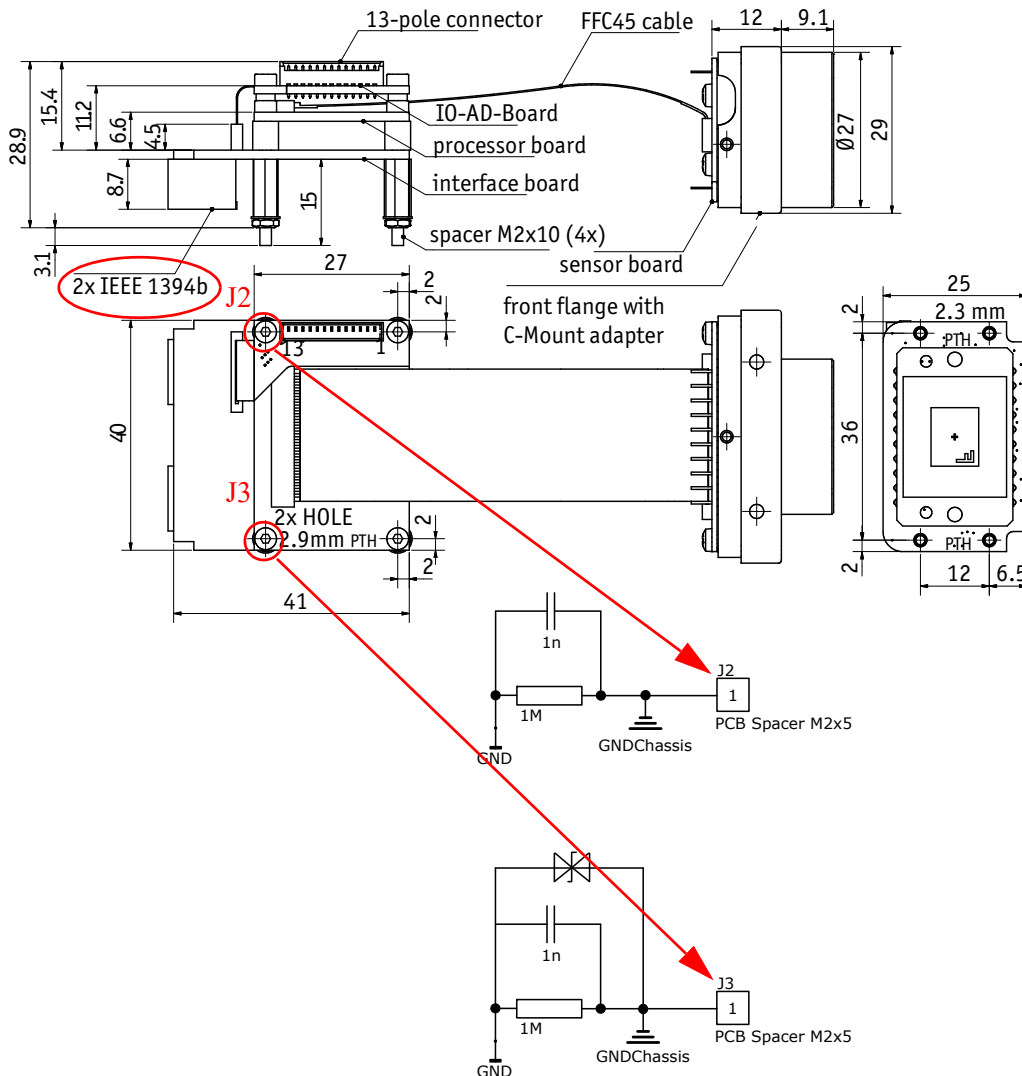
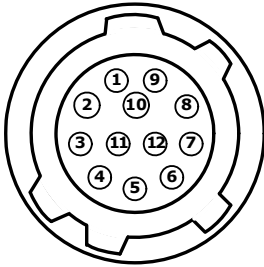

Figure 34: Board level camera: two IEEE 1394b FireWire connectors

Camera I/O connections

Note

The camera is not intended to be connected to a DC distribution network. The maximum length for I/O cables must not exceed 30 m.



Camera side Hirose HR10-10R-12PA(73) connector					I/O cable color code
Pin	Signal	Direction	Level	Description	
1	External GND		GND for RS232 and ext. power	External Ground for RS232 and external power	Blue
2	External Power		+8 to +36 VDC	Power supply	Red
3	Camera Out 4	Out	Open emitter	Camera Output 4 (GPOut4) default: -	Violet
4	Camera In 1	In	$U_{in}(\text{high}) = 3 \text{ to } 24 \text{ V}$ $U_{in}(\text{low}) = 0 \text{ to } 1.5 \text{ V}$	Camera Input 1 (GPIn1) default: Trigger	Grey
5	Camera Out 3	Out	Open emitter	Camera Output 3 (GPOut3) default: Busy	Yellow
6	Camera Out 1	Out	Open emitter	Camera Output 1 (GPOut1) default: IntEna	Green
7	Camera In GND	In	Common GND for inputs	Camera Common Input Ground (In GND)	Brown
8	RxD RS232	In	RS232	Terminal Receive Data	White
9	TxD RS232	Out	RS232	Terminal Transmit Data	Black
10	Camera Out Power	In	Common VCC for outputs maximum 36 VDC	External Power for digital outputs (OutVCC)	Orange
11	Camera In 2	In	$U_{in}(\text{high}) = 3 \text{ to } 24 \text{ V}$ $U_{in}(\text{low}) = 0 \text{ to } 1.5 \text{ V}$	Camera Input 2 (GPIn2) default: -	White/Black
12	Camera Out 2	Out	Open emitter	Camera Output 2 (GPOut2) default: Follow CameraIn2	White/Brown

(For board level see chapter [Board level camera: I/O pin assignment](#) on page 104)

Table 20: Camera I/O connector pin assignment and Stingray I/O cable color coding

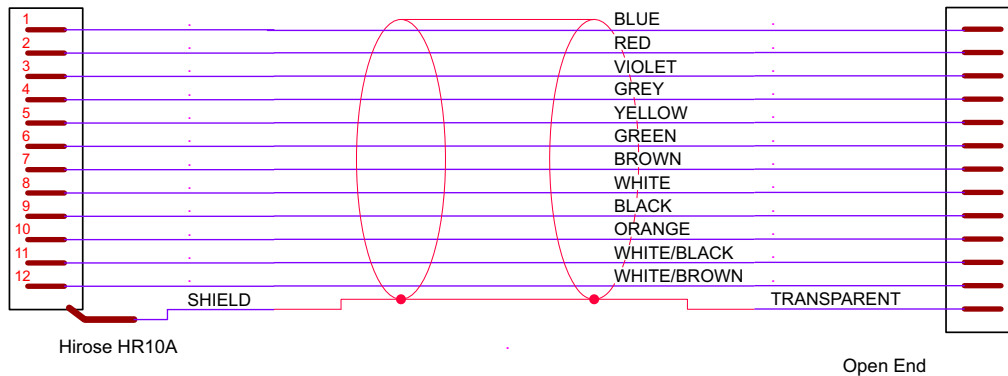

Figure 35: Stingray cable color coding

Note

12-pin Hirose I/O cables



The General Purpose I/O port has a Hirose HR10-10R-12PA(73) connector on the camera side. The mating cable connector is:

- Hirose HR10A-10P-12S(73) for soldering
- Hirose HR10A-10P-12SC(73) for crimping

Note

GP = General Purpose



For a detailed description of the I/O connector and its operating instructions see the 1394 Installation Manual, Chapter *Stingray input description*.

Read all Notes and Cautions in the 1394 Installation Manual, before using the I/O connector.

Board level camera: I/O pin assignment

The following diagram shows the 13-pole I/O pin connector of a board level camera:

13-pole I/O connector:
 [Molex 1.25mm Pitch PicoBlade Wire-to-Board Header (53047-1310)]

1 = GND (for RS232, Ext PWR)	7 = GND (for Inputs)
2 = Ext PWR input (PWR output on demand)	8 = Rx/D 9 = Tx/D
3 = Output 4	10 = Power Input (for Output ports)
4 = Input 1	11 = Input 2
5 = Output 3	12 = Output 2
6 = Output 1	13 = Cable Shield

FFC45 cable length:
 FFC45 L = 56 mm K7500307
 FFC45 L = 110 mm K7500318

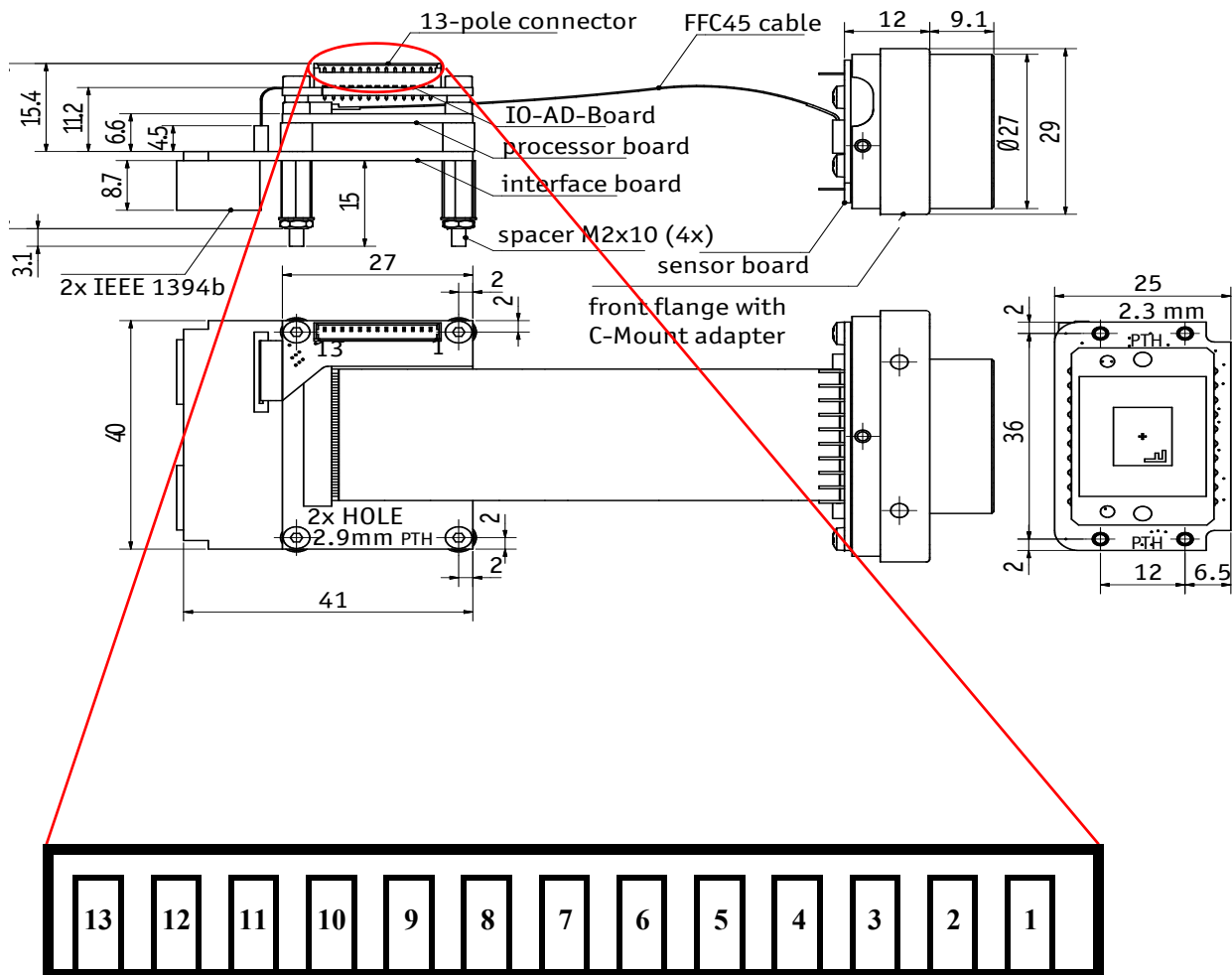

Figure 36: Board level camera: I/O pin assignment

Status LEDs

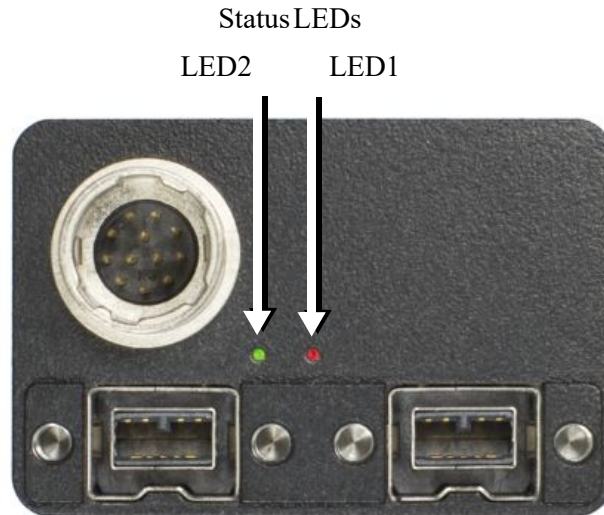

Figure 37: Position of status LEDs

Each of the two LEDs is tricolor: showing green, red, or orange.

RED means: red LED permanent on

RED blinking means: red LED blinks fast

+RED pulsing means: red LED is switched on for a short time. If the red LED is already on, the LED will be switched off. The state of the other color of the same LED could be on or off

GREEN means: green LED permanent on

GREEN blinking means: green LED blinks fast

+GREEN pulsing means: green LED is switched on for a short time. If the green LED is already on, the LED will be switched off. The state of the other color of the same LED could be on or off

+GREEN pulsing (inverted) means: green LED is switched off for a short time.

Note



Both LEDs can be switched off by:

- Setting bit [17] to 1, see [Table 165](#) on page 330
- Activating **Disable LED functionality** check box in SmartView (**Adv3** tab).

Error conditions will be shown although LEDs are switched off

Normal conditions

Event	LED1	LED2
Camera startup	During startup all LEDs are switched on consecutively to show the startup progress: Phase1: LED1 RED Phase2: LED1 RED + LED1 GREEN Phase3: LED1 RED + LED1 GREEN + LED2 RED Phase4: LED1 RED + LED1 GREEN + LED2 RED + LED2 GREEN	
Power on		GREEN
Bus reset		GREEN blinking
Asynchronous traffic	+GREEN pulsing	GREEN
Isochronous traffic	+RED pulsing	GREEN
Waiting for external trigger	RED	GREEN
External trigger event	RED	+RED pulsing

Table 21: LEDs showing normal conditions

Error conditions

LED1 RED → LED2 GREEN ↓	Warning 1 pulse	DCAM 2 pulse	MISC 3 pulse	FPGA 4 pulse	Stack 5 pulse
FPGA boot error				1-5 pulse	
Stack setup					1 pulse
Stack start					2 pulse
No FLASH object			1 pulse		
No DCAM object		1 pulse			
Register mapping		3 pulse			
VMode_ERROR_STATUS	1 pulse				
FORMAT_7_ERROR_1	2 pulse				
FORMAT_7_ERROR_2	3 pulse				

Table 22: Error codes

Control data signals

The inputs and outputs of the camera can be configured by software. The different modes are described below.

Inputs

Note For a general description of the **inputs** and **warnings** see the **1394 Installation Manual**, Chapter **Stingray input description**.



The optocoupler inverts all input signals. Inversion of the signal is controlled via the IO_INP_CTRL1 to 2 register (see [Table 23](#) on page 108).

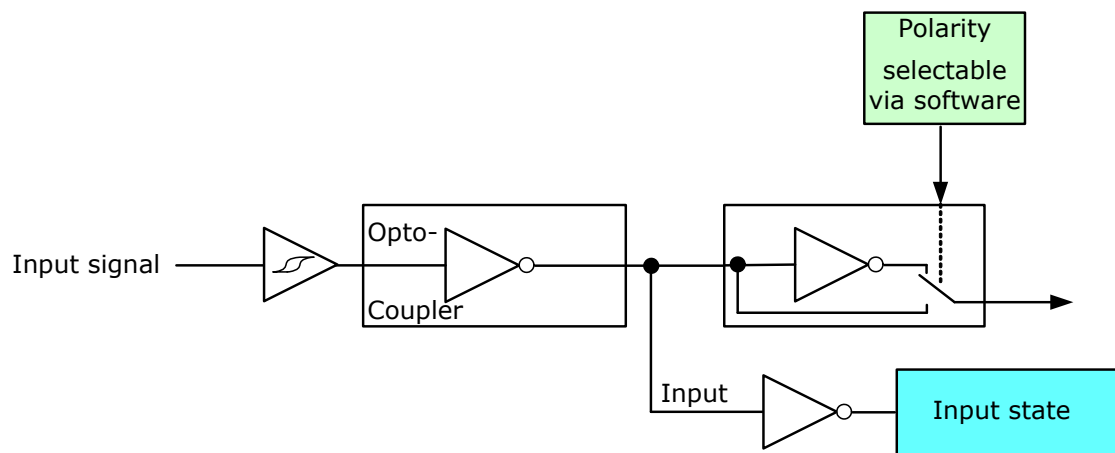

Figure 38: Input block diagram

Triggers

All inputs configured as triggers are linked by AND. If several inputs are being used as triggers, a high signal must be present on all inputs in order to generate a trigger signal. Each signal can be inverted. The camera must be set to **external triggering** to trigger image capture by the trigger signal.

Input/output pin control

All input and output signals running over the camera I/O connector are controlled by an advanced feature register.

Register	Name	Field	Bit	Description
0xF100300	IO_INP_CTRL1	Presence_Inq	[0]	Indicates presence of this feature (read only)
		---	[1 to 6]	Reserved
		Polarity	[7]	0: Signal not inverted 1: Signal inverted
		---	[8 to 10]	Reserved
		InputMode	[11 to 15]	Mode see Table 24 on page 108
		---	[16 to 30]	Reserved
		PinState	[31]	RD: Current state of pin
0xF100304	IO_INP_CTRL2	Same as IO_INP_CTRL1		

Table 23: Advanced register: Input control

IO_INP_CTRL 1-2

The **Polarity** flag determines whether the input is low active (0) or high active (1). The **input mode** can be seen in the following table. The **PinState** flag is used to query the current status of the input.

The **PinState** bit reads the inverting optocoupler status after an internal negation. See [Figure 38: Input block diagram](#) on page 107.

This means that an open input sets the **PinState** bit to **0**. (This is different to Marlin, where an open input sets **PinState** bit to **1**.)

ID	Mode	Default
0x00	Off	
0x01	Reserved	
0x02	Trigger input	Input 1
0x03	Reserved	
0x06	Sequence Step	
0x07	Sequence Reset	
0x08 to 0x1F	Reserved	

Table 24: Input routing

Note If you set more than 1 input to function as a trigger input, all trigger inputs are ANDed.



Trigger delay

Stingray cameras feature various ways to delay image capture based on external trigger.

With IIDC V1.31 there is a standard CSR at Register F0F00534/834h to control a delay up to FFFh x time base value.

The following table explains the inquiry register and the meaning of the various bits.

Register	Name	Field	Bit	Description
0xF0F00534	TRIGGER_DELAY_INQUIRY	Presence_Inq	[0]	Indicates presence of this feature (read only)
		Abs_Control_Inq	[1]	Capability of control with absolute value
		---	[2]	Reserved
		One_Push_Inq	[3]	One-push auto mode (controlled automatically by the camera once)
		Readout_Inq	[4]	Capability of reading out the value of this feature
		ON_OFF	[5]	Capability of switching this feature ON and OFF
		Auto_Inq	[6]	Auto mode (controlled automatically by the camera)
		Manual_Inq	[7]	Manual mode (controlled by user)
		Min_Value	[8 to 19]	Minimum value for this feature
		Max_Value	[20 to 31]	Maximum value for this feature

Table 25: Trigger delay inquiry register

Register	Name	Field	Bit	Description
0xF0F00834	TRIGGER_DELAY	Presence_Inq	[0]	Presence of this feature: 0: N/A 1: Available
		Abs_Control	[1]	Absolute value control 0: Control with value in the value field 1: Control with value in the absolute value CSR. If this bit=1 the value in the value field has to be ignored.
		---	[2 to 5]	Reserved
		ON_OFF	[6]	Write ON or OFF this feature Read: Status of the feature ON=1 OFF=0
		---	[7 to 19]	Reserved
		Value	[20 to 31]	Value

Table 26: Trigger Delay CSR

The cameras also have an advanced register which allows even more precise image capture delay after receiving a hardware trigger.

Trigger delay advanced register

Register	Name	Field	Bit	Description
0xF1000400	TRIGGER_DELAY	Presence_Inq	[0]	Indicates presence of this feature (read only)
		---	[1 to 5]	Reserved
		ON_OFF	[6]	Trigger delay on/off
		---	[7 to 10]	Reserved
		DelayTime	[11 to 31]	Delay time in μ s

Table 27: Trigger delay advanced CSR

The advanced register allows the start of the integration to be delayed by maximum 2^{21} μ s, which is maximum 2.1 s after a trigger edge was detected.

Note

- Switching trigger delay to ON also switches external Trigger_Mode_0 to ON.
- This feature works with external Trigger_Mode_0 only.

Outputs
Note

For a general description of the outputs and warnings see the 1394 Installation Manual, Chapter Stingray output description.

Output features are configured by software. Any signal can be placed on any output.

The main features of output signals are described below:

Signal	Description
IntEna (Integration Enable) signal	This signal displays the time in which exposure was made. By using a register this output can be delayed by up to 1.05 seconds.
Fval (Frame valid) signal	This feature signals readout from the sensor. This signal Fval follows IntEna.
Busy signal	This signal appears when: <ul style="list-style-type: none"> • the exposure is being made or • the sensor is being read out or • data transmission is active. The camera is busy.
PulseWidthMod (pulse-width modulation) signal	Each output has pulse-width modulation (PWM) capabilities, which can be used for motorized speed control or autofocus control. See chapter Pulse-width modulation (Stingray housing and Stingray board level models) on page 116
WaitingForTrigger signal	This signal is available and useful for the outputs in Trigger Edge Mode . (In level mode it is available but useless, because exposure time is unknown. (Signal always =0)) In edge mode it is useful to know if the camera can accept a new trigger (without overtriggering). See Table 30 on page 114 and Table 40 on page 115

Table 28: Output signals

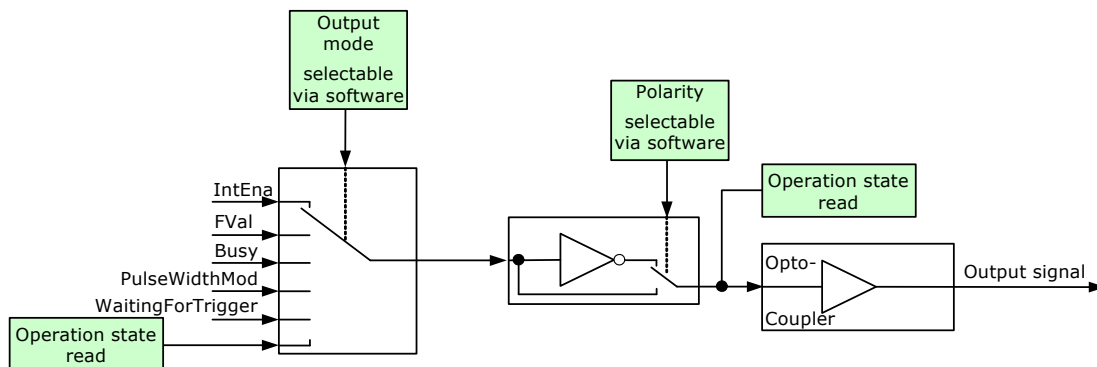

Figure 39: Output block diagram

IO_OUTP_CTRL 1-4

The outputs (output mode, polarity) are controlled via 4 advanced feature registers (see [Table 29](#) on page 113).

The **Polarity** field determines whether the output is inverted or not. For the **Output mode** see [Table 30](#) on page 114 for details. The current status of the output can be queried and set via the **PinState**.

It is possible to read back the status of an output pin regardless of the output mode. For example, this allows the host computer to determine if the camera is busy by simply polling the BUSY output.

Note Outputs in **Direct Mode**:



For correct functionality the **polarity should always be set to 0** (SmartView: Trig/IO tab, Invert=No).

Output control

Register	Name	Field	Bit	Description
0xF1000320	IO_OUTP_CTRL1	Presence_Inq	[0]	Indicates presence of this feature (read only)
		PWMCapable	[1]	Indicates if an output pin supports the PWM feature. See Table 31 on page 116.
		---	[2 to 6]	Reserved
		Polarity	[7]	0: Signal not inverted 1: Signal inverted
		---	[8 to 10]	Reserved
		Output mode	[11 to 15]	Mode see Table 30 on page 114
		---	[16 to 30]	Reserved
		PinState	[31]	RD: Current state of pin WR: New state of pin
0xF1000324	IO_OUTP_CTRL2	Same as IO_OUTP_CTRL1		
0xF1000328	IO_OUTP_CTRL3	Same as IO_OUTP_CTRL1		
0xF100032C	IO_OUTP_CTRL4	Same as IO_OUTP_CTRL1		

Table 29: Advanced register: Output control

Output modes

ID	Mode	Default / description
0x00	Off	
0x01	Output state follows PinState bit	Using this mode, the Polarity bit has to be set to 0 (not inverted). This is necessary for an error free display of the output status.
0x02	Integration enable	Output 1
0x03	Reserved	
0x04	Reserved	
0x05	Reserved	
0x06	FrameValid	
0x07	Busy	Output 2
0x08	Follow corresponding input (Inp1 → Out1, Inp2 → Out2)	
0x09	PWM (=pulse-width modulation)	Stingray housed and board level models
0x0A	WaitingForTrigger	Only in Trigger Edge Mode . All other Mode = 0 WaitingForTrigger is useful to know, if a new trigger will be accepted.
0x0B to 0x1F	Reserved	

Table 30: Output modes

PinState 0 switches off the output transistor and produces a low level over the resistor connected from the output to ground.

The following diagram illustrates the dependencies of the various output signals.

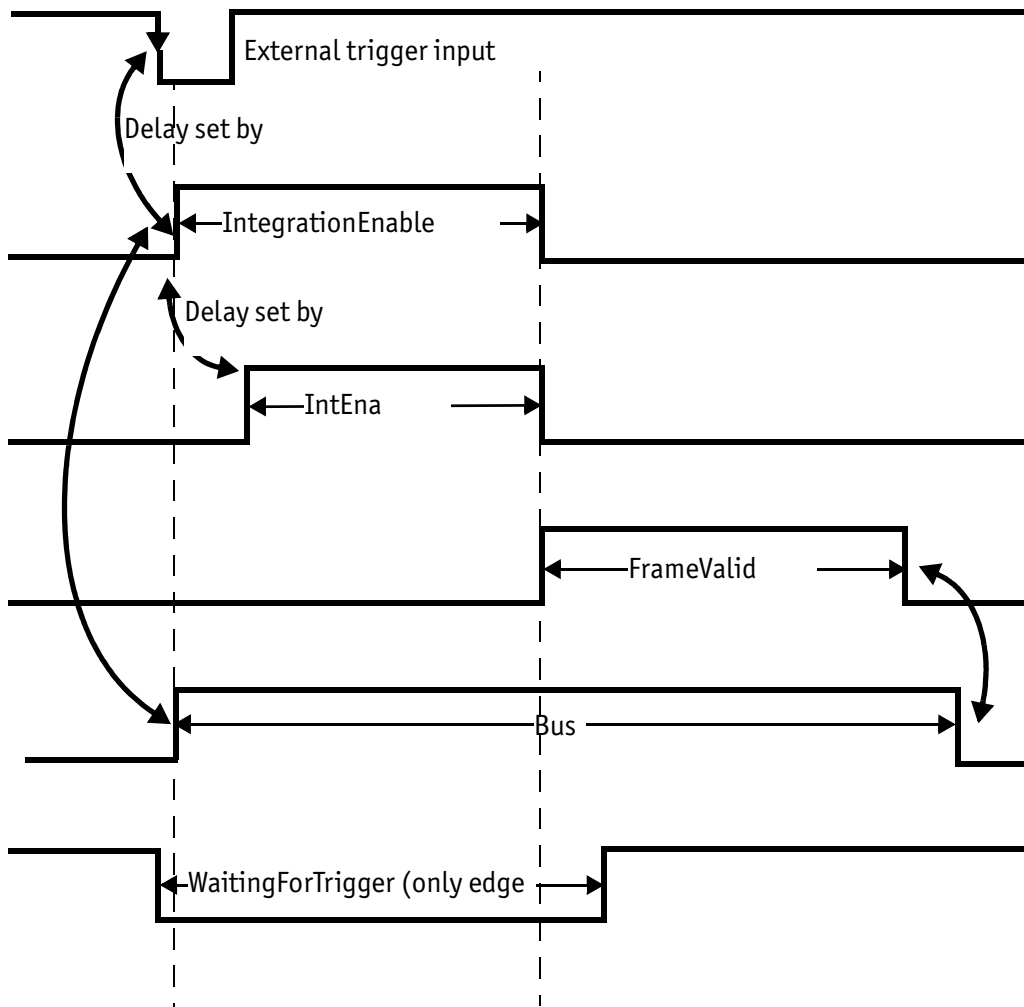

Figure 40: Output impulse diagram

Note The signals can be inverted.



Caution Firing a new trigger while **IntEna** is still active can result in **missing image**.



Note

- Note that **trigger delay** delays the image capture, whereas **IntEna_Delay** only delays the leading edge of IntEna output signal, but it does not delay the image capture.
- The outputs can be set by software. In this case, the achievable maximum frequency is strongly dependent on individual software capabilities. As a rule of thumb, the camera itself will limit the toggle frequency to not more than 700 Hz.

Pulse-width modulation (Stingray housing and Stingray board level models)

The 2 inputs and 4 outputs are independent. Each output has pulse-width modulation (PWM) capabilities, which can be used for motorized speed control or autofocus control with additional external electronics.

Period and pulse width are adjustable via the following registers. For additional examples see chapter [PWM: Examples in practice](#) on page 118:

Register	Name	Field	Bit	Description
0xF1000800	IO_OUTP_PWM1	Presence_Inq	[0]	Indicates presence of this feature (read only)
		---	[1]	Reserved
		---	[2 to 3]	Reserved
		MinPeriod	[4 to 19]	Minimum PWM period in μ s (read only)
		---	[20 to 27]	Reserved
		---	[28 to 31]	Reserved
0xF1000804		PulseWidth	[0 to 15]	PWM pulse width in μ s
		Period	[16 to 31]	PWM period in μ s
0xF1000808	IO_OUTP_PWM2	Same as IO_OUTP_PWM1		
0xF100080C				
0xF1000810	IO_OUTP_PWM3	Same as IO_OUTP_PWM1		
0xF1000814				
0xF1000818	IO_OUTP_PWM4	Same as IO_OUTP_PWM1		
0xF100081C				

Table 31: PWM configuration registers

To enable the PWM feature select output mode 0x09. Control the signal state via the **PulseWidth** and **Period** fields (all times in μ s).

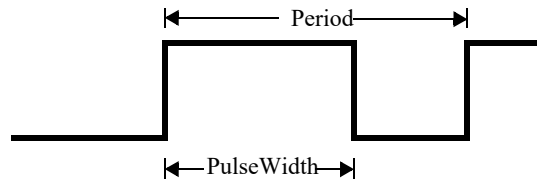

Figure 41: PulseWidth and Period definition

Note

Note the following conditions:



- PulseWidth < Period
- Period ≥ MinPeriod

PWM: minimal and maximal periods and frequencies

The following formulas present the minimal/maximal periods and frequencies for the pulse-width modulation (PWM).

$$\text{period}_{\min} = 3\mu\text{s}$$

$$\Rightarrow \text{frequency}_{\max} = \frac{1}{\text{period}_{\min}} = \frac{1}{3\mu\text{s}} = 333.33\text{kHz}$$

$$\text{frequency}_{\min} = \frac{1}{2^{16} \times 10^{-6}\text{s}} = 15.26\text{Hz}$$

$$\Rightarrow \text{period}_{\max} = \frac{1}{\text{frequency}_{\min}} = 2^{16}\mu\text{s}$$

Formula 1: Minimal/maximal period and frequency

PWM: Examples in practice

This chapter presents two examples, on how to write values in the PWM registers. All values have to be written in microseconds in the PWM registers.

Example 1:

Set PWM with 1kHz at 30% pulse width.

$$\text{RegPeriod} = \frac{1}{\text{frequency} \times 10^{-6} \text{ s}} = \frac{1}{1 \text{ kHz} \times 10^{-6} \text{ s}} = 1000$$

$$\text{RegPulseWidth} = \text{RegPeriod} \times 30\% = 1000 \times 30\% = 300$$

Formula 2: PWM example 1

Example 2:

Set PWM with 250 Hz at 12% pulse width.

$$\text{RegPeriod} = \frac{1}{\text{frequency} \times 10^{-6} \text{ s}} = \frac{1}{250 \text{ Hz} \times 10^{-6} \text{ s}} = 4000$$

$$\text{RegPulseWidth} = \text{RegPeriod} \times 12\% = 4000 \times 12\% = 480$$

Formula 3: PWM example 2

Pixel data

Pixel data are transmitted as isochronous data packets in accordance with the IEEE 1394 interface described in IIDC V1.31. The first packet of a frame is identified by the **1** in the **sync bit** (sy) of the packet header.

0 to 7		8 to 15		16 to 23		24 to 31		
data_length				tg	channel		tCode	sy
header_CRC								
Video data payload								
data_CRC								

sync bit
↓

Table 32: Isochronous data block packet format. Source: IIDC V1.31

Field	Description
data_length	Number of bytes in the data field
tg	Tag field shall be set to zero
channel	Isochronous channel number , as programmed in the iso_channel field of the cam_sta_ctrl register
tCode	Transaction code shall be set to the isochronous data block packet tCode
sy	Synchronization value (sync bit) This is one single bit. It indicates the start of a new frame. It shall be set to 0001h on the first isochronous data block of a frame, and shall be set to zero on all other isochronous blocks
Video data payload	Shall contain the digital video information

Table 33: Description of data block packet format

- The video data for each pixel are output in either 8-bit or 14-bit format (**Packed 12-Bit Mode: 12-bit format**).
- Each pixel has a range of 256 or 16384 (**Packed 12-Bit Mode: 4096**) shades of gray.
- The digital value 0 is black and 255 or 65535 (**Packed 12-Bit Mode: 4095**) is white, but only every fourth value is used. In 16-bit mode the data output is MSB aligned.

The following tables provide a description of the video data format for the different modes. (Source: IIDC V1.31; packed 12-bit mode: Allied Vision)

<YUV8 (4:2:2) format>

Each component has 8-bit data.

<YUV8 (4:2:2) format>			
$U_{(K+0)}$	$Y_{(K+0)}$	$V_{(K+0)}$	$Y_{(K+1)}$
$U_{(K+2)}$	$Y_{(K+2)}$	$V_{(K+2)}$	$Y_{(K+3)}$
$U_{(K+4)}$	$Y_{(K+4)}$	$V_{(K+4)}$	$Y_{(K+5)}$
$U_{(K+Pn-6)}$	$Y_{(K+Pn-6)}$	$V_{(K+Pn-6)}$	$Y_{(K+Pn-5)}$
$U_{(K+Pn-4)}$	$Y_{(K+Pn-4)}$	$V_{(K+Pn-4)}$	$Y_{(K+Pn-3)}$
$U_{(K+Pn-2)}$	$Y_{(K+Pn-2)}$	$V_{(K+Pn-2)}$	$Y_{(K+Pn-1)}$

Table 34: YUV8 (4:2:2) format: Source: IIDC V1.31

<YUV8 (4:1:1) format>

Each component has 8-bit data.

<YUV8 (4:1:1) format>			
$U_{(K+0)}$	$Y_{(K+0)}$	$Y_{(K+1)}$	$V_{(K+0)}$
$Y_{(K+2)}$	$Y_{(K+3)}$	$U_{(K+4)}$	$Y_{(K+4)}$
$Y_{(K+5)}$	$V_{(K+4)}$	$Y_{(K+6)}$	$Y_{(K+7)}$
$U_{(K+Pn-8)}$	$Y_{(K+Pn-8)}$	$Y_{(K+Pn-7)}$	$V_{(K+Pn-8)}$
$Y_{(K+Pn-6)}$	$Y_{(K+Pn-5)}$	$U_{(K+Pn-4)}$	$Y_{(K+Pn-4)}$
$Y_{(K+Pn-3)}$	$V_{(K+Pn-4)}$	$Y_{(K+Pn-2)}$	$Y_{(K+Pn-1)}$

Table 35: YUV8 (4:1:1) format: Source: IIDC V1.31

<Y (Mono8/Raw8) format>

Y component has 8-bit data.

<Y (Mono8/Raw8) format>			
$Y_{(K+0)}$	$Y_{(K+1)}$	$Y_{(K+2)}$	$Y_{(K+3)}$
$Y_{(K+4)}$	$Y_{(K+5)}$	$Y_{(K+6)}$	$Y_{(K+7)}$
$Y_{(K+Pn-8)}$	$Y_{(K+Pn-7)}$	$Y_{(K+Pn-6)}$	$Y_{(K+Pn-5)}$
$Y_{(K+Pn-4)}$	$Y_{(K+Pn-3)}$	$Y_{(K+Pn-2)}$	$Y_{(K+Pn-1)}$

Table 36: Y (Mono8) format: Source: IIDC V1.31 / Y (Raw8) format: Allied Vision

<Y (Mono16/Raw16) format>

Y component has 16-bit data.

<Y (Mono16) format>	
High byte	Low byte
$Y_{(K+0)}$	$Y_{(K+1)}$
$Y_{(K+2)}$	$Y_{(K+3)}$
$Y_{(K+Pn-4)}$	$Y_{(K+Pn-3)}$
$Y_{(K+Pn-2)}$	$Y_{(K+Pn-1)}$

Table 37: Y (Mono16) format: Source: IIDC V1.31

<Y (Mono12/Raw12) format>

<Y (Mono12) format>			
$Y_{(K+0)}$ [11 to 4]	$Y_{(K+1)}$ [3 to 0] $Y_{(K+0)}$ [3 to 0]	$Y_{(K+1)}$ [11 to 4]	$Y_{(K+2)}$ [11 to 4]
$Y_{(K+3)}$ [3 to 0] $Y_{(K+2)}$ [3 to 0]	$Y_{(K+3)}$ [11 to 4]	$Y_{(K+4)}$ [11 to 4]	$Y_{(K+5)}$ [3 to 0] $Y_{(K+4)}$ [3 to 0]
$Y_{(K+5)}$ [11 to 4]	$Y_{(K+6)}$ [11 to 4]	$Y_{(K+7)}$ [3 to 0] $Y_{(K+6)}$ [3 to 0]	$Y_{(K+7)}$ [11 to 4]

 Table 38: **Packed 12-Bit Mode** (mono and RAW) Y12 format (Allied Vision)

<RGB8 format>

Each component has 8-bit data.

<RGB8 format>			
$R_{(K+0)}$	$G_{(K+0)}$	$B_{(K+0)}$	$R_{(K+1)}$
$G_{(K+1)}$	$B_{(K+1)}$	$R_{(K+2)}$	$G_{(K+2)}$
$B_{(K+2)}$	$R_{(K+3)}$	$G_{(K+3)}$	$B_{(K+3)}$
$R_{(K+Pn-4)}$	$G_{(K+Pn-4)}$	$B_{(K+Pn-4)}$	$R_{(K+Pn-3)}$
$G_{(K+Pn-3)}$	$B_{(K+Pn-3)}$	$R_{(K+Pn-2)}$	$G_{(K+Pn-2)}$
$B_{(K+Pn-2)}$	$R_{(K+Pn-1)}$	$G_{(K+Pn-1)}$	$B_{(K+Pn-1)}$

Table 39: RGB8 format: Source: IIDC V1.31

<Y(Mono8/Raw8), RGB8>

Each component (Y, R, G, B) has 8-bit data. The data type is *Unsigned Char*.

Y, R, G, B	Signal level (decimal)	Data (hexadecimal)
Highest	255	0xFF
	254	0xFE
	.	.
	.	.
Lowest	1	0x01
	0	0x00

Figure 42: Data structure of Mono8, RGB8; Source: IIDC V1.31 / Y(Mono8/Raw8) format: Allied Vision

<YUV8>

Each component (Y, U, V) has 8-bit data. The Y component is the same as in the above table.

U, V	Signal level (decimal)	Data (hexadecimal)
Highest (+)	127	0xFF
	126	0xFE
	.	.
	.	.
Lowest	1	0x81
	0	0x80
Highest (-)	-1	0x7F
	-127	0x01
	-128	0x00

Figure 43: Data structure of YUV8; Source: IIDC V1.31

<Y(Mono16)>

Y component has 16-bit data. The data type is *Unsigned Short (big-endian)*.

Y	Signal level (decimal)	Data (hexadecimal)
Highest	65535	0xFFFF
	65534	0xFFFE
	.	.
	.	.
Lowest	1	0x0001
	0	0x0000

Figure 44: Data structure of Y(Mono16); Source: IIDC V1.31

<Y(Mono12)>

Y component has 12-bit data. The data type is *unsigned*.

Y	Signal level (decimal)	Data (hexadecimal)
Highest	4095	0x0FFF
	4094	0x0FFE
	.	.
	.	.
Lowest	1	0x0001
	0	0x0000

Table 40: Data structure of **Packed 12-Bit Mode** (mono and RAW) (Allied Vision)

Description of the data path

Block diagrams of the cameras

The following diagrams illustrate the data flow and the bit resolution of image data after being read from the CCD sensor chip in the camera. The individual blocks are described in more detail in the following paragraphs. For sensor data see chapter [Specifications](#) on page 45.

Monochrome cameras

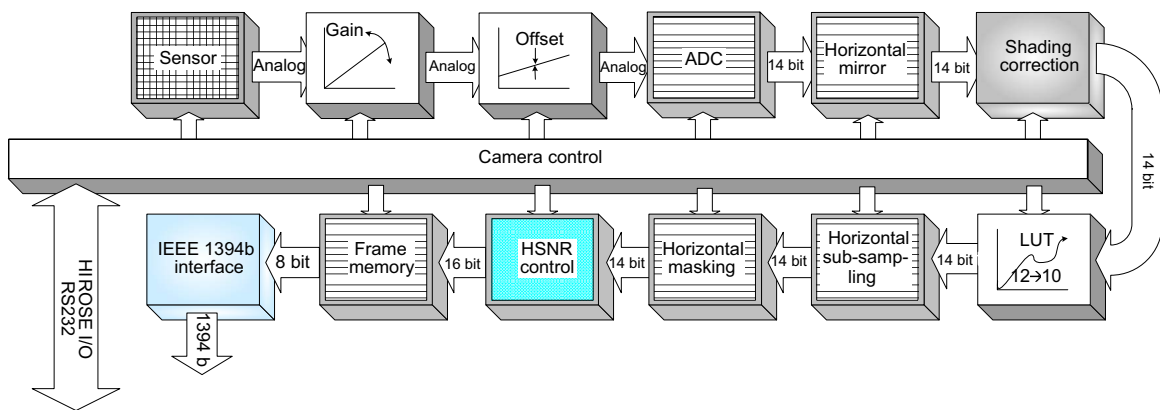

Setting LUT = OFF: Effectively makes full use of the 14-bit by bypassing the LUT circuitry
 Setting LUT = ON: The most significant 12 bit of the 14-bit are used and further down converted to 10 bit

Figure 45: Block diagram monochrome camera

Color cameras

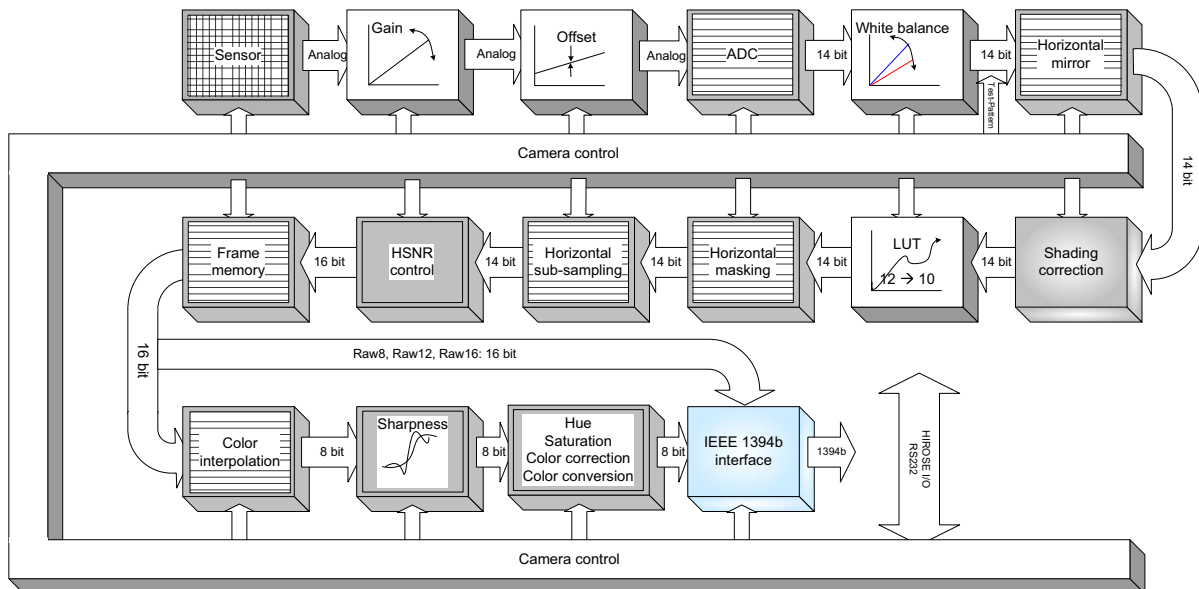

Setting LUT = OFF: Effectively makes full use of the 14-bit by bypassing the LUT circuitry
 Setting LUT = ON: The most significant 12 bit of the 14-bit are used and further down converted to 10 bit

Figure 46: Block diagram color camera

White balance

There are two types of white balance:

- one-push white balance: white balance is done only once (not continuously)
- auto white balance (AWB): continuously optimizes the color characteristics of the image

Stingray color cameras have both one-push white balance and auto white balance.

White balance is applied so that non-colored image parts are displayed non-colored.

From the user's point, the white balance settings are made in register 80Ch of IIDC V1.31. This register is described in more detail below.

Register	Name	Field	Bit	Description
0xF0F0080C	WHITE_BALANCE	Presence_Inq	[0]	Presence of this feature: 0: N/A 1: Available
		Abs_Control	[1]	Absolute value control 0: Control with value in the Value field 1: Control with value in the Absolute value CSR If this bit=1, the value in the Value field will be ignored.
		---	[2 to 4]	Reserved
		One_Push	[5]	Write 1: begin to work (self-cleared after operation) Read: 1: in operation 0: not in operation If A_M_Mode = 1, this bit will be ignored.
		ON_OFF	[6]	Write: ON or OFF this feature Read: read a status 0: OFF 1: ON
		A_M_MODE	[7]	Write: set mode Read: read current mode 0: MANUAL 1: AUTO
		U/B_Value	[8 to 19]	U/B value This field is ignored when writing the value in Auto or OFF mode. If readout capability is not available, reading this field has no meaning.
		V/R_Value	[20 to 31]	V/R value This field is ignored when writing the value in Auto or OFF mode. If readout capability is not available, reading this field has no meaning.

Table 41: White balance register

The values in the U/B_Value field produce changes from green to blue; the V/R_Value field from green to red as illustrated below.

Note While lowering both U/B and V/R registers from 284 towards 0, the lower one of the two effectively controls the green gain.

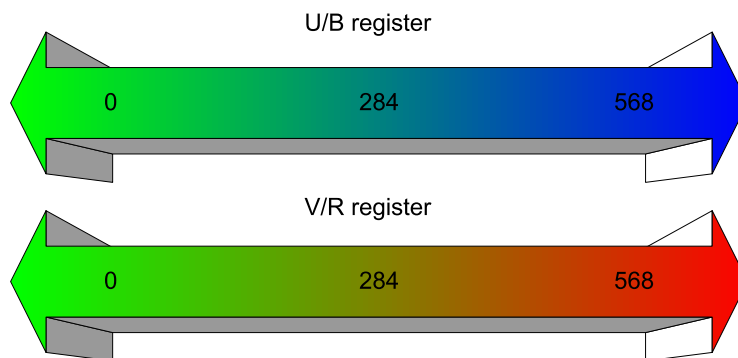

Figure 47: U/V slider range

Type	Range	Range in dB
Stingray color cameras	0 to 568	± 10 dB

Table 42: Manual gain range of the various Stingray types

The increment length is ~0.0353 dB/step.

One-push white balance

Note Configuration



To configure this feature in control and status register (CSR): See [Table 41](#) on page 127.

The camera automatically generates frames, based on the current settings of all registers (GAIN, OFFSET, SHUTTER, etc.).

For white balance, in total 9 frames are processed. The whole image or a subset of it is used for the white balance algorithm. The R-G-B component values of the samples are added and are used as actual values for the one-push white balance.

This feature assumes that the R-G-B component sums of the samples shall be equal; i.e., that the average of the sampled grid pixels is monochrome.

Note The following ancillary condition should be observed for successful white balance:



- There are no stringent or special requirements on the image content, it requires only the presence of monochrome pixels in the image.

If the image capture is active (e.g. IsoEnable set in register 614h), the frames used by the camera for white balance are also output on the IEEE 1394 bus. Any previously active image capture is restarted after the completion of white balance.

The following flow diagram illustrates the one-push white balance sequence.

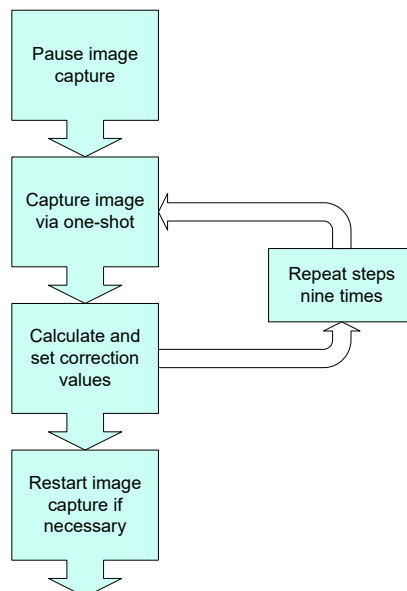

Figure 48: One-push white balance sequence

Finally, the calculated correction values can be read from the WHITE_BALANCE register 80Ch.

Auto white balance (AWB)

The auto white balance feature continuously optimizes the color characteristics of the image.

For the white balance algorithm the whole image or a subset of it is used.

Auto white balance can also be enabled by using an external trigger. However, if there is a pause of >10 seconds between capturing individual frames this process is aborted.

Note The following ancillary conditions should be observed for successful white balance:



- There are no stringent or special requirements on the image content, it requires only the presence of equally weighted RGB pixels in the image.
- Auto white balance can be started both during active image capture and when the camera is in idle state.

Note Configuration



To set position and size of the control area (Auto_Function_AOI) in an advanced register: see [Table 146](#) on page 312.

AUTOFNC_AOI affects the auto shutter, auto gain and auto white balance features and is independent of the Format_7 AOI settings. If this feature is switched off the work area position and size will follow the current active image size.

Within this area, the R-G-B component values of the samples are added and used as actual values for the feedback.

The following drawing illustrates the AUTOFNC_AOI settings in greater detail.

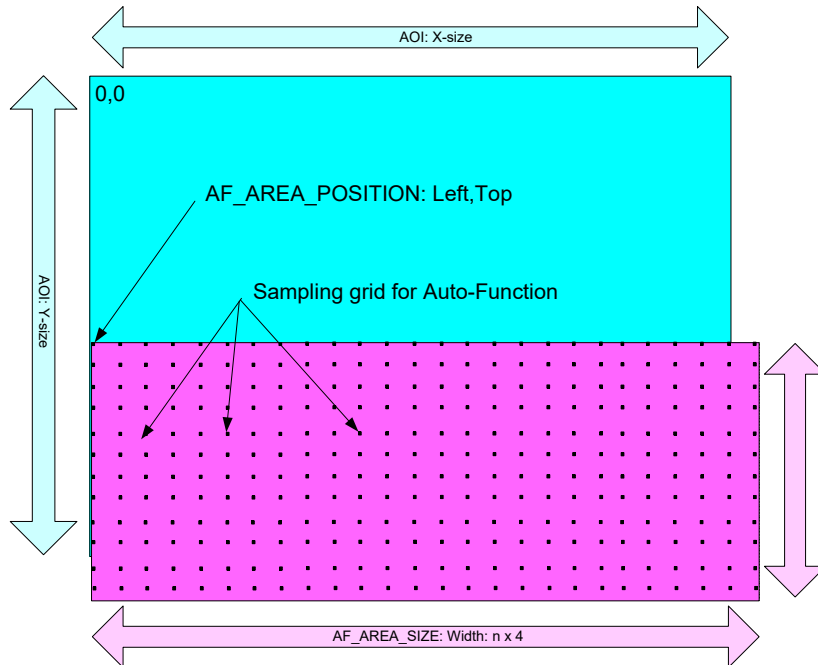

Figure 49: AUTOFNC_AOI positioning

The algorithm is assumed that the R-G-B component sums of the samples are equal, i.e., that the mean of the sampled grid pixels is monochrome.

Auto shutter

Stingray cameras are equipped with auto shutter feature. When enabled, the auto shutter adjusts the shutter within the default shutter limits or within those set in advanced register F1000360h in order to reach the reference brightness set in auto exposure register.

Note Target grey level parameter in SmartView corresponds to Auto_exposure register 0xF0F00804 (IIDC).



Increasing the auto exposure value increases the average brightness in the image and vice versa.

The applied algorithm uses a proportional plus integral controller (PI controller) to achieve minimum delay with zero overshoot.

To configure this feature in control and status register (CSR):

Register	Name	Field	Bit	Description
0xF0F0081C	SHUTTER	Presence_Inq	[0]	Presence of this feature: 0: N/A 1: Available
		Abs_Control	[1]	Absolute value control 0: Control with value in the Value field 1: Control with value in the Absolute value CSR If this bit=1, the value in the Value field will be ignored.
		---	[2 to 4]	Reserved
		One_Push	[5]	Write 1: begin to work (self-cleared after operation) Read: 1: in operation 0: not in operation If A_M_Mode = 1, this bit will be ignored.
		ON_OFF	[6]	Write: ON or OFF this feature Read: read a status 0: OFF 1: ON
		A_M_MODE	[7]	Write: set mode Read: read current mode 0: MANUAL 1: AUTO
		---	[8 to 19]	Reserved
		Value	[20 to 31]	Read/Write Value This field is ignored when writing the value in Auto or OFF mode. If readout capability is not available, reading this field has no meaning.

Table 43: CSR: Shutter

Note

Configuration

To configure this feature in an advanced register: See [Table 144](#) on page 309.

Auto gain

All Stingray cameras are equipped with auto gain feature.

Note

Configuration

To configure this feature in an advanced register: See [Table 145](#) on page 311.

When enabled auto gain adjusts the gain within the default gain limits or within the limits set in advanced register F1000370h in order to reach the brightness set in auto exposure register as reference.

Increasing the auto exposure value (target grey value) increases the average brightness in the image and vice versa.

The applied algorithm uses a proportional plus integral controller (PI controller) to achieve minimum delay with zero overshoot.

The following tables show the gain and auto exposure CSR.

Register	Name	Field	Bit	Description
0xF0F00820	GAIN	Presence_Inq	[0]	Presence of this feature: 0: N/A 1: Available
		Abs_Control	[1]	Absolute value control 0: Control with value in the value field 1: Control with value in the absolute value CSR If this bit=1 the value in the value field has to be ignored.
		---	[2 to 4]	Reserved
		One_Push	[5]	Write: Set bit high to start Read: Status of the feature: Bit high: WIP Bit low: Ready
		ON_OFF	[6]	Write: ON or OFF this feature Read: read a status 0: OFF 1: ON
		A_M_MODE	[7]	Write: set mode Read: read current mode 0: MANUAL 1: AUTO
		---	[8 to 19]	Reserved
		Value	[20 to 31]	Read/Write Value This field is ignored when writing the value in Auto or OFF mode. If readout capability is not available, reading this field has no meaning.

Table 44: CSR: Gain

Register	Name	Field	Bit	Description
0xF0F00804	AUTO_EXPOSURE	Presence_Inq	[0]	Presence of this feature: 0: N/A 1: Available
		Abs_Control	[1]	Absolute value control 0: Control with value in the value field 1: Control with value in the absolute value CSR If this bit=1 the value in the value field has to be ignored.
		---	[2 to 4]	Reserved
		One_Push	[5]	Write: Set bit high to star Read: Status of the feature: Bit high: WIP Bit low: Ready
		ON_OFF	[6]	Write: ON or OFF this feature Read: read a status 0: OFF 1: ON
		A_M_MODE	[7]	Write: set mode Read: read current mode 0: MANUAL 1: AUTO
		---	[8 to 19]	Reserved
		Value	[20 to 31]	Read/Write Value This field is ignored when writing the value in Auto or OFF mode. If readout capability is not available, reading this field has no meaning.

Table 45: CSR: Auto Exposure

Note



Configuration

To configure this feature in an advanced register: See [Table 145](#) on page 311.

Note

- Values can only be changed within the limits of gain CSR.
- Changes in auto exposure register only have an effect when auto gain is active.
- Auto exposure limits are 50 to 205. (SmartView→Ctrl1 tab: Target grey level)

Manual gain

Stingray cameras are equipped with a gain setting, allowing the gain to be manually adjusted on the fly by means of a simple command register write.

The following ranges can be used when manually setting the gain for the analog video signal:

Type	Range	Range in dB	Increment length
Stingray color cameras	0 to 680	0 to 24.4 dB	~0.0359 dB/step
Stingray monochrome cameras	0 to 680	0 to 24.4 dB	
Stingray F-504B/C	0 to 670	0 to 24.053 dB	

Table 46: Manual gain range of the various Stingray types

Note

- Setting the gain does not change the offset (black value)
- A higher gain produces greater image noise. This reduces image quality. For this reason, try first to increase the brightness, using the aperture of the camera optics and/or longer shutter settings.

Brightness (black level or offset)

It is possible to set the black level in the camera within the following ranges:

0 to +16 gray values (@ 8 bit)

Increments are in 1/64 LSB (@ 8 bit)

Note

- Setting the gain does not change the offset (black value).



The IIDC register brightness at offset 800h is used for this purpose.

The following table shows the BRIGHTNESS register:

Register	Name	Field	Bit	Description
0xF0F00800	BRIGHTNESS	Presence_Inq	[0]	Presence of this feature: 0: N/A 1: Available
		Abs_Control	[1]	Absolute value control 0: Control with value in the value field 1: Control with value in the absolute value CSR If this bit=1 the value in the value field has to be ignored
		---	[2 to 4]	Reserved
		One_Push	[5]	Write: Set bit high to start Read: Status of the feature: Bit high: WIP Bit low: Ready
		ON_OFF	[6]	Write: ON or OFF this feature Read: read a status 0: OFF 1: ON
		A_M_MODE	[7]	Write: set mode Read: read current mode 0: MANUAL 1: AUTO
		---	[8 to 19]	Reserved
		Value	[20 to 31]	Read/Write Value; this field is ignored when writing the value in Auto or OFF mode; if readout capability is not available reading this field has no meaning.

Table 47: CSR: Brightness

Horizontal mirror function

All Stingray cameras are equipped with an electronic mirror function, which mirrors pixels from the left side of the image to the right side and vice versa.

The mirror is centered to the current FOV center and can be combined with all image manipulation functions, like binning and shading.

This function is especially useful when the camera is looking at objects with the help of a mirror or in certain microscopy applications.

Note Configuration



To configure this feature in an advanced register: See [Table 138](#) on page 302.

Note



The use of the mirror function with color cameras and image output in RAW format has implications on the BAYER-ordering of the colors.

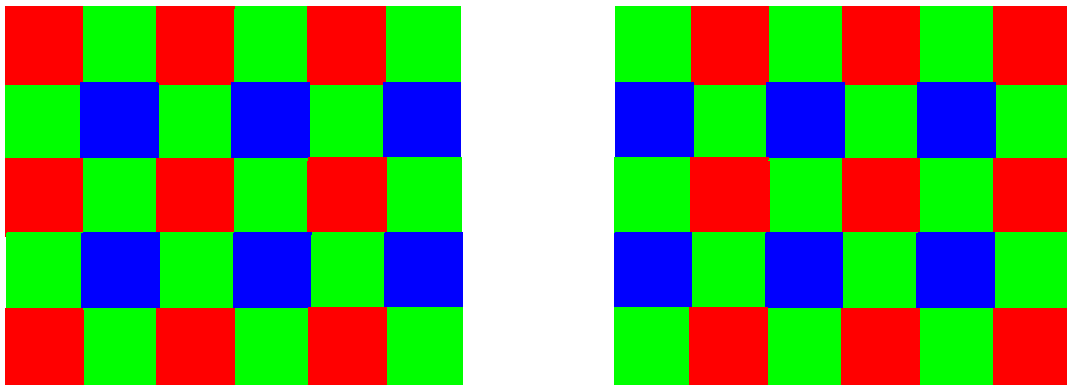

Mirror OFF: R-G-G-B (all Stingray color cameras) Mirror ON: G-R-B-G (all Stingray color cameras)

Figure 50: Mirror and Bayer order

Note During switchover one image may be corrupted.



Shading correction

Shading correction is used to compensate for non-homogeneities caused by lighting or optical characteristics within specified ranges.

To correct a frame, a multiplier from 1–2 is calculated for each pixel in 1/256 steps: this allows for shading to be compensated by up to 50 %.

Besides generating shading data off-line and downloading it to the camera, the camera allows correction data to be generated automatically in the camera itself.

Note



- Shading correction does not support the mirror function.
- If you use shading correction with mirror function, activate the mirror before building shading image.
- Due to binning and sub-sampling in the Format_7 modes read the following hints to build shading image in Format_7 modes.

Building shading image in Format_7 modes

horizontal Binning/sub-sampling is always done after shading correction. Shading is always done on full horizontal resolution. Therefore shading image has always to be built in full horizontal resolution.

vertical Binning, sub-sampling and mirror are done before shading correction. Therefore, shading image has to be built in the correct vertical resolution and with needed mirror settings.

Note



- Build shading image always with the full horizontal resolution (0 x horizontal binning / 0 x horizontal sub-sampling), but with the desired vertical binning/sub-sampling/mirror.
- Shading correction in F7 mode 0 (Mono8) is only available up to S400.

First example

4 x horizontal binning, 2 x vertical binning

⇒ build shading image with 0 x horizontal binning and 2 x vertical binning

Second example

2 out of 8 horizontal sub-sampling, 2 out of 8 vertical sub-sampling

⇒ build shading image with 0 x horizontal sub-sampling and 2 out of 8 vertical sub-sampling

How to store shading image

There are two storing possibilities:

- After generating the shading image in the camera, it can be uploaded to the host computer for nonvolatile storage purposes.
- The shading image can be stored in the camera itself.

The following illustration shows the process of automatic generation of correction data. Surface plots and histograms were created using the ImageJ program.

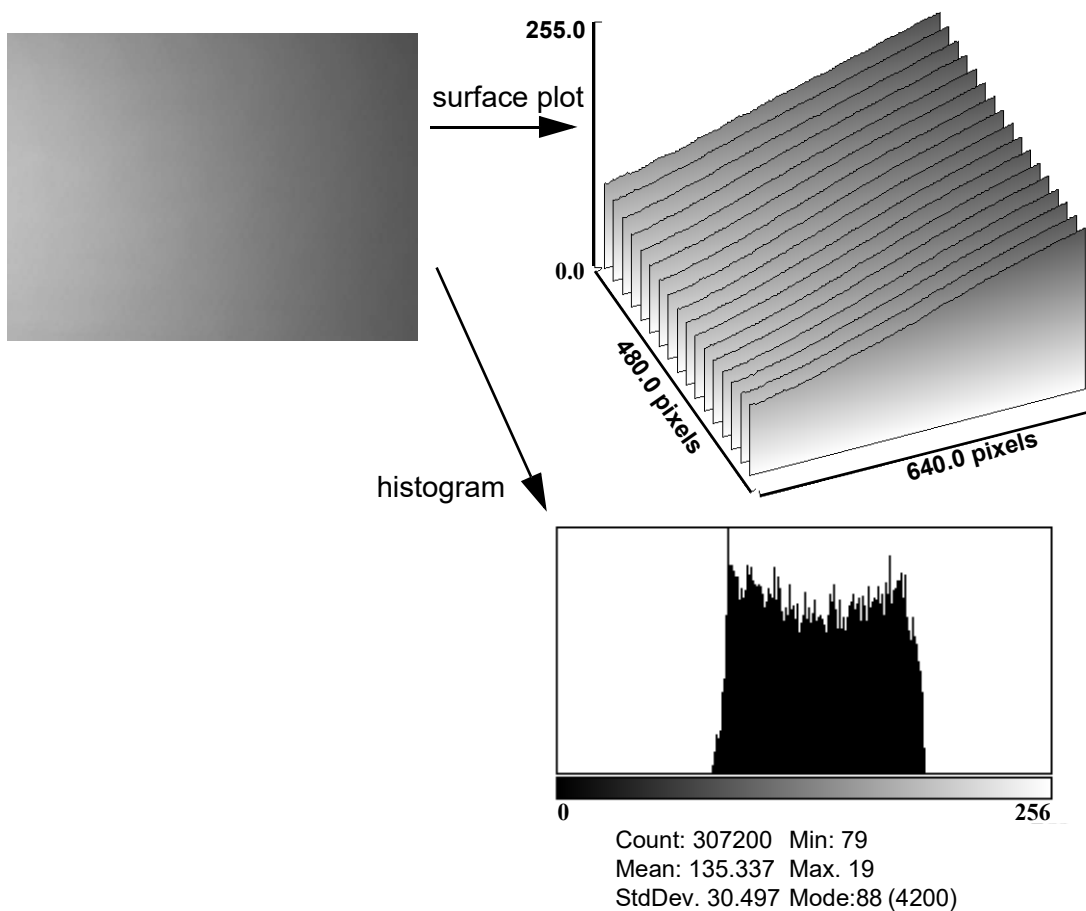

Figure 51: Shading correction: Source image with non-uniform illumination

- The source image with non-uniform illumination (on the left).
- The surface plot on the right clearly shows a gradient of the brightness (0: brightest → 255: darkest pixels).
- The histogram shows a wide band of gray values.

High-frequency image data is removed from the source image, by defocussing the lens; therefore, this data is not included in the shading image.

Automatic generation of correction data

Requirements

Shading correction compensates for non-homogeneities by giving all pixels the same gray value as the brightest pixel. This means that only the background must be visible and the brightest pixel has a gray value of less than 255 when automatic generation of shading data is started.

It may be necessary to use a neutral white reference, e.g. a piece of paper, instead of the real image.

Algorithm

After the start of automatic generation, the camera pulls in the number of frames set in the GRAB_COUNT register. Recommended values are 2, 4, 8, 16, 32, 64, 128, or 256. An arithmetic mean value is calculated from them to reduce noise.

Consecutively, a search is made for the brightest pixel in the mean value frame. The brightest pixel(s) remain unchanged. A factor is then calculated for each pixel to be multiplied by, giving it the gray value of the brightest pixel.

All of these multipliers are saved in a shading reference image. The time required for this process depends on the number of frames to be calculated and on the resolution of the image.

Correction alone can compensate for shading by up to 50% and relies on full resolution data to minimize the generation of missing codes.

The following flowchart shows the process in detail:

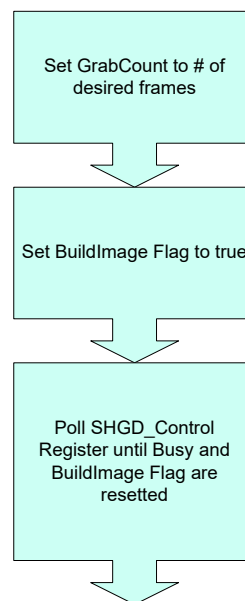

Figure 52: Automatic generation of a shading image

Note

Configuration



To configure this feature in an advanced register: See [Table 138](#) on page 302.

Note

- The SHDG_CTRL register should not be queried at very short intervals. This is because each query delays the generation of the shading image. An optimal interval time is 500 ms.

Note

- Calculation of shading data is always carried out at the current resolution setting. If the AOI is later larger than the window in which correction data was calculated, none of the pixels lying outside are corrected.
- For Format_7 mode, it is advisable to generate the shading image in the largest displayable frame format. This ensures that any smaller AOIs are completely covered by the shading correction.
- Automatic generation of shading data can also be enabled when image capture is already running. The camera then pauses the running image capture for the time needed for generation and resumes after generation is completed.
- Shading correction can be combined with the image mirror and gamma functionality.
- Changing binning modes involves the generation of new shading reference images due to a change in the image size.

After the lens has been focused again the image below will be seen, but now with a considerably more uniform gradient.

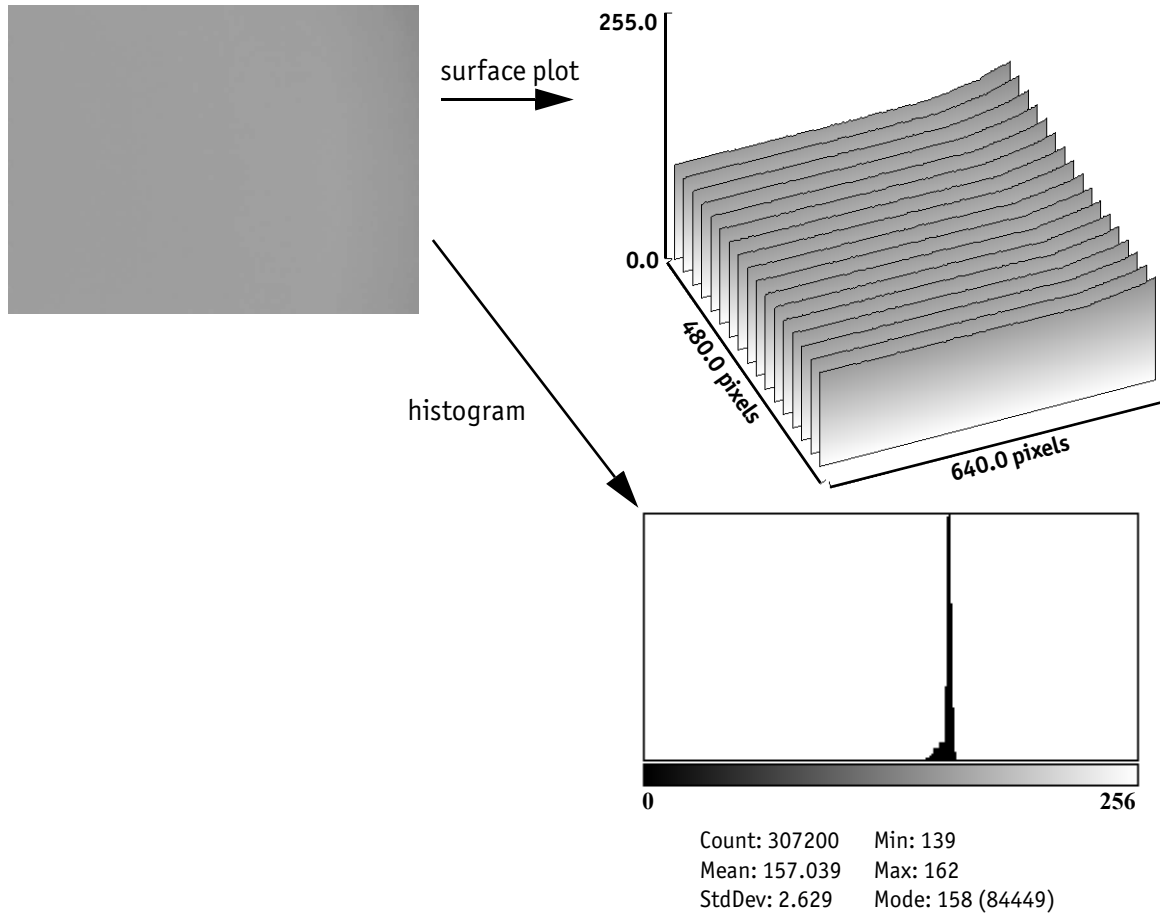

Figure 53: Example of shaded image

- The image after shading correction (on the left).
- The surface plot on the right clearly shows nearly no more gradient of the brightness (0: brightest → 255: darkest pixels). The remaining gradient is related to the fact that the source image is lower than 50% on the right hand side.
- The histogram shows a peak with very few different gray values.

Loading a shading image out of the camera

Gpdata_BUFFER is used to load a shading image out of the camera. Because the size of a shading image is larger than Gpdata_BUFFER, input must be handled in several steps:

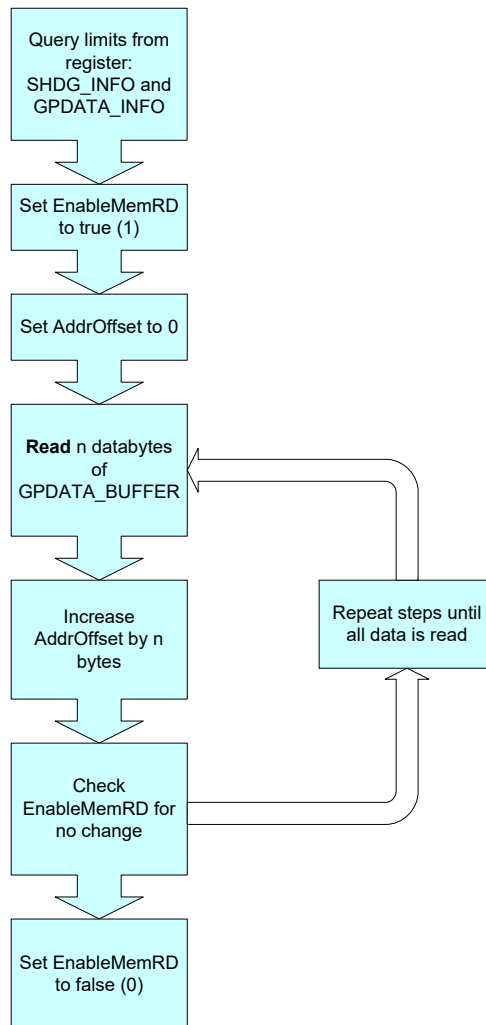

Figure 54: Uploading shading image to host

Note



Configuration

- To configure this feature in an advanced register: See [Table 138](#) on page 302.
- For information on Gpdata_BUFFER: See chapter [Gpdata_BUFFER](#) on page 328.

Loading a shading image into the camera

Gpdata_BUFFER is used to load a shading image into the camera. Because the size of a shading image is larger than Gpdata_BUFFER, input must be handled in several steps (see chapter [Reading or writing shading image from/into the camera](#) on page 303).

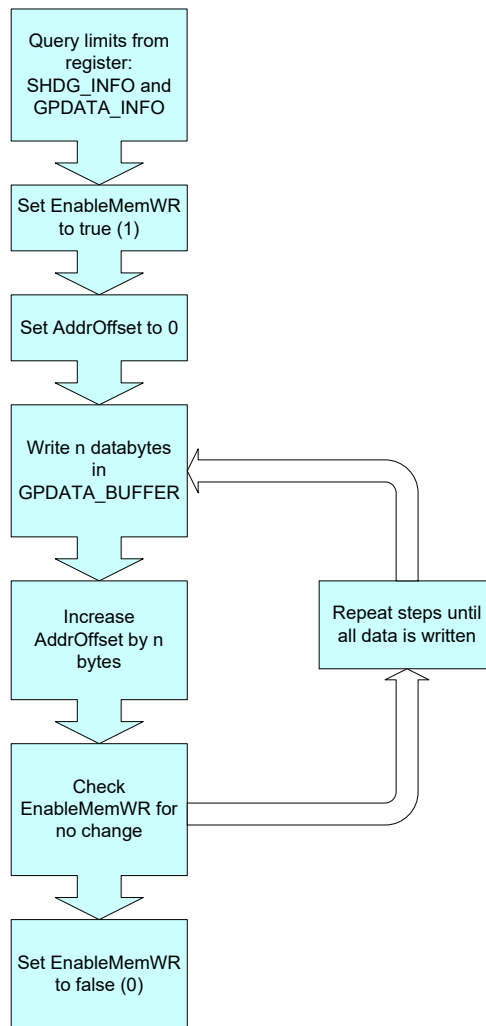

Figure 55: Loading the shading reference image

Note



Configuration

- To configure this feature in an advanced register: See [Table 138](#) on page 302.
- For information on Gpdata_BUFFER: See chapter [Gpdata_BUFFER](#) on page 328.

Look-up table (LUT) and gamma function

The Stingray camera provides one user-defined LUT. The use of this LUT allows any function (in the form $\text{Output} = F(\text{Input})$) to be stored in the camera's RAM and to be applied on the individual pixels of an image at run-time.

The address lines of RAM are connected to the incoming digital data, these in turn point to the values of functions calculated offline; e.g., with a spreadsheet program.

This function needs to be loaded into the camera's RAM before use.

One example of using an LUT is the gamma LUT:

There is one gamma LUT (gamma = 0.45)

$$\text{Output} = (\text{Input})^{0.45}$$

This gamma LUT is used with all Stingray models.

Gamma is known as compensation for the nonlinear brightness response of many displays e.g. CRT monitors. The LUT converts the incoming 12 bit from the digitizer to outgoing 10 bit.

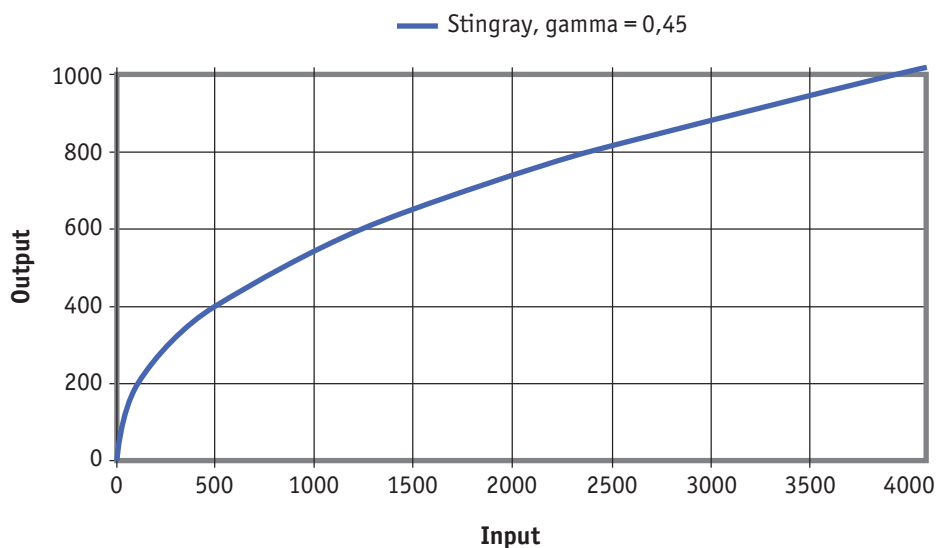

Figure 56: LUT with gamma = 0.45 and $\text{Output} = f(\text{Input})$

Note



- The input value is the most significant 12-bit value from the digitizer.
- Gamma 1 (gamma=0.45) switches on the LUT. After overriding the LUT with a user defined content, gamma functionality is no longer available until the next full initialization of the camera.
- LUT content is volatile if you do not use the user profiles to save the LUT.

Loading an LUT into the camera

Loading the LUT is carried out through the data exchange buffer called Gpdata_BUFFER. As this buffer can hold a maximum of 2 KB, and a complete LUT at 4096 x 10 bit is 5 KB, programming can not take place in a one block write step because the size of an LUT is larger than Gpdata_BUFFER. Therefore, input must be handled in several steps, as shown in the following flow diagram.

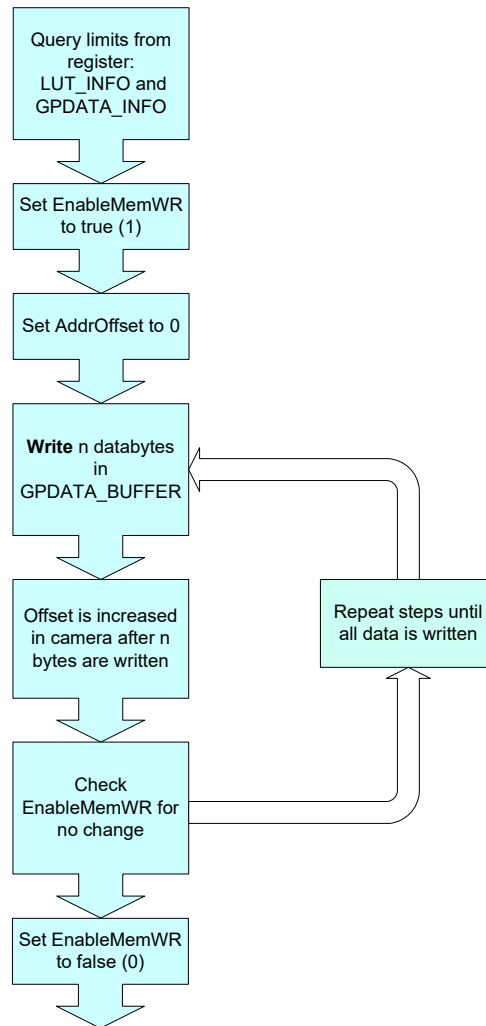

Figure 57: Loading an LUT

Note



Configuration

- To configure this feature in an advanced register: See [Table 137](#) on page 300.
- For information on Gpdata_BUFFER: See chapter [Gpdata_BUFFER](#) on page 328.

Defect pixel correction

The mechanisms of defect pixel correction are explained in the following drawings. All examples are done in Format_7 Mode_0 (full resolution).

The X marks a defect pixel.

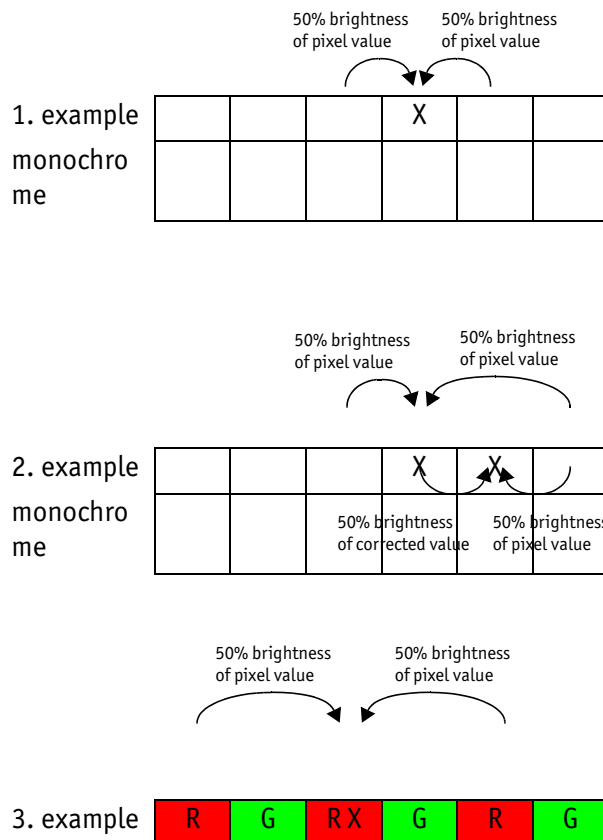

Figure 58: Mechanisms of defect pixel correction

Building defect pixel correction image in Format_7 modes

horizontal Binning/sub-sampling is always done after defect pixel correction. Defect pixel correction is always done on full horizontal resolution. Therefore, defect pixel detection has always to be done in full horizontal resolution.

vertical Binning/sub-sampling is done in the sensor, before defect pixel correction. Therefore, defect pixel detection has to be done in the correct vertical resolution.

Note Detect defect pixels always with the full horizontal resolution (0 x horizontal binning / 0 x horizontal sub-sampling), but with the desired vertical binning/sub-sampling.



First example

4 x horizontal binning, 2 x vertical binning

⇒ detect defect pixels with 0 x horizontal binning and 2 x vertical binning

Second example

2 out of 8 horizontal sub-sampling, 2 out of 8 vertical sub-sampling

⇒ detect defect pixels with 0 x horizontal sub-sampling and 2 out of 8 vertical sub-sampling

Flow diagram of defect pixel correction

The following flow diagram illustrates the defect pixel detection:

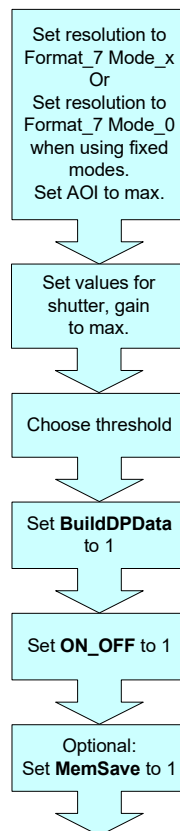

Figure 59: Defect pixel correction: build and store

Note

While building defect pixel correction data or uploading them from host, the defect pixel correction data are stored volatile in FPGA.

Optional you can store the data in a non-volatile memory (Set MemSave to 1).

Note

Configuration

To configure this feature in an advanced register: See [Table 142](#) on page 306.

Building defect pixel data**Note**

- Defect pixel detection is only possible in Mono8/Raw8 modes. In all other modes you get an error message in advanced register 0xF1000298 bit [1] see [Table 142](#) on page 306.
- Using Format_7 Mode_x: Defect pixel detection is done in Format_7 Mode_x.
- Using a fixed format (Format_0, Format_1 or Format_2): Defect pixel detection is done in Format_7 Mode_0.
- When using defect pixel correction with binning and sub-sampling: first switch to binning/sub-sampling mode and then apply defect pixel detection.
- Optional: To improve the quality of defect pixel detection, activate HSNR mode additionally.
- There is a maximum of 256 defect pixels that can be found. If the algorithm detects more defect pixels, then it will end with an error. For more details, see [DPDataSize](#) register on page 307.

To build defect pixel data perform the following steps:

Grab an image with defect pixel data

1. Take the camera, remove lens, and put on lens cap.
2. Set image resolution to Format_7 Mode_x or Format_7 Mode_0 (when using fixed modes) and set AOI to maximum.
3. Set values for shutter and gain to maximum
4. Grab a single image.

Calculate defect pixel coordinates

5. Accept default threshold from system or choose a different threshold.

Note

A mean value is calculated over the entire image that is grabbed internal.

Definition: A defect pixel is every pixel value of this previously grabbed image that is:

- greater than (mean value + threshold)
- or
- less than (mean value - threshold)

6. Set the BuildDPData flag to 1.

In microcontroller the defect pixel calculation is started. The detected defect pixel coordinates are stored in the dual port RAM of the FPGA.

Defect pixel coordinates are:

- 16-bit y-coordinate and
- 16-bit x-coordinate

The calculated mean value is written in advanced register Mean field (0xF1000298 bit [18 to 24]).

The number of defect pixels is written in advanced register DPDataSize (0xF100029C bit [4 to 17]). Due to 16-bit format: to get the number of defect pixels read out this value and divide through 4. For more information see [Table 142](#) on page 306.

Reset values (resolution, shutter, gain, brightness)

7. Take the camera, remove lens cap, and thread the lens onto the camera.
8. Reset values for image resolution, shutter, gain, and brightness (offset) to their previous values.
9. Grab a single image (one-shot).

Activate/deactivate defect pixel correction

Activate:

1. Set ON_OFF flag to 1.

The defect pixel correction is activated in FPGA.

Deactivate:

1. Set ON_OFF flag to 0.

The defect pixel correction is deactivated in FPGA.

Store defect pixel data non-volatile

1. Set the MemSave flag to 1.

All previous calculated defect pixel coordinates are transferred from the dual port RAM to the EEPROM on the sensor board.

- ⇒ Defect pixel data is stored twice in the camera:
- Stored volatile: in dual port RAM
 - Stored non-volatile: in EEPROM

Load non-volatile stored defect pixel data

1. Set the MemLoad flag to 1.

All non-volatile stored defect pixel coordinates within the EEPROM are loaded into the dual port RAM.

Note



- Switch off camera and switch on again:
⇒ defect pixel data in dual port RAM will get lost
- Start-up camera / initialize camera:
⇒ non-volatile stored defect pixel data are loaded automatically from EEPROM to dual port RAM.

Send defect pixel data to the host

1. Set EnaMemRD flag to 1.

Defect pixel data is transferred from dual port RAM to host.

2. Read DPDataSize.

This is the current defect pixel count from the camera.

Receive defect pixel data from the host

1. Set EnaMemWR flag to 1.

Defect pixel data is transferred from host to dual port RAM.

DPC data: storing mechanism

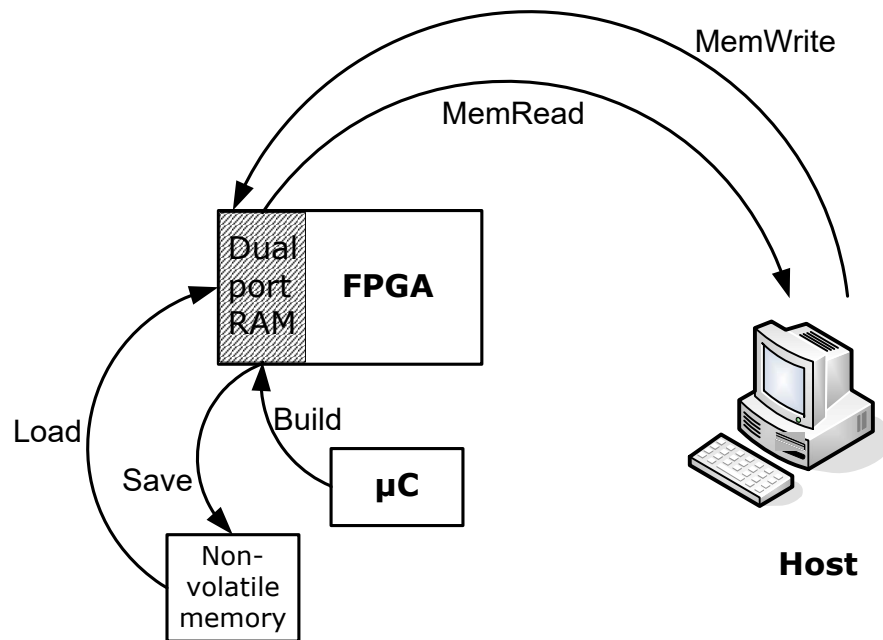

Figure 60: DPC data: storing mechanism

Binning (only Stingray monochrome models and F-201C/504C)

2 x / 4 x / 8 x binning (F-201C only 2 x vertical binning)

Definition. Binning is the process of combining neighboring pixels while being read out from the CCD chip.

Note



- Only Stingray monochrome cameras and Stingray F-201C, F-504C have this feature
- Stingray F-201C: color binning
- Stingray F-504C: usual binning (no color binning)
- Binning does not change offset, brightness or blacklevel

Binning is used primarily for 3 reasons:

- A reduction in the number of pixels; thus, the amount of data while retaining the original image area angle
- An increase in the frame rate (vertical binning only)
- A brighter image, resulting in an improvement in the signal-to-noise ratio of the image (depending on the acquisition conditions)

Signal-to-noise ratio (SNR) and signal-to-noise separation specify the quality of a signal with regard to its reproduction of intensities. The value signifies how high the ratio of noise is in regard to the maximum achievable signal intensity.

The higher this value, the better the signal quality. The unit of measurement used is decibel (dB).

However, the advantages of increasing signal quality are accompanied by a reduction in resolution.

Only Format_7 Binning is possible only in video Format_7. The type of binning used depends on the video mode.

Note Changing binning modes involves the generation of new shading reference images due to a change in the image size.



Types In general, we distinguish between the following types of binning (H = horizontal, V = vertical):

- 2 x H-binning
- 2 x V-binning
- 4 x H-binning
- 4 x V-binning
- 8 x H-binning
- 8 x V-binning

and the full binning modes:

- 2 x full binning (a combination of 2 x H-binning and 2 x V-binning)
- 4 x full binning (a combination of 4 x H-binning and 4 x V-binning)
- 8 x full binning (a combination of 8 x H-binning and 8 x V-binning)

Vertical binning

Vertical binning increases light sensitivity of the camera by a factor of two (4 or 8) by adding together the values of two (4 or 8) adjoining vertical pixels output as a single pixel. This is done directly in the horizontal shift register of the sensor.

Format_7 Mode_2. By default and without further remapping use Format_7 Mode_2 for 2 x vertical binning.

This reduces vertical resolution, depending on the model.

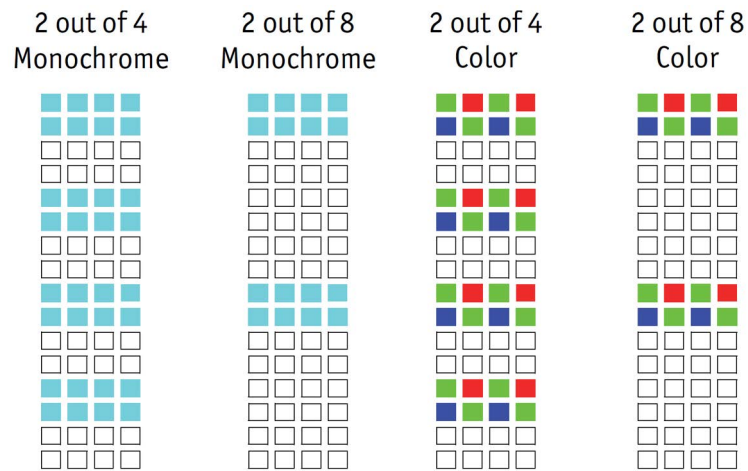

Figure 61: Vertical binning

4x vertical binning combines 4 pixels to 1 pixel in a row.

Note For Stingray F-201C only 2x vertical binning is available.



Note If vertical binning is activated the image may appear to be over-exposed and may require correction.



Note Vertical resolution is reduced, but signal-to noise ratio (SNR) is increased by about 3, 6 or 9 dB (2 x, 4 x or 8 x binning).



Note The image appears vertically compressed in this mode and no longer exhibits a true aspect ratio.



Horizontal binning (F-201C only 2 x horizontal binning)

F-504C has 2x/4x/8x horizontal binning (no color binning)

Definition. In horizontal binning adjacent horizontal pixels in a line are combined digitally in the FPGA of the camera without accumulating the black level:

2 x horizontal binning: 2 pixel signals from 2 horizontal neighboring pixels are combined.

4 x horizontal binning: 4 pixel signals from 4 horizontal neighboring pixels are combined.

8 x horizontal binning: 8 pixel signals from 8 horizontal neighboring pixels are combined.

Horizontal binning	Light sensitivity	Signal-to-noise ratio
2x	6dB	3dB
4x	12dB	6dB
8x	18dB	9dB

Table 48: Binning affecting light sensitivity and signal-to-noise ratio

Horizontal resolution. Horizontal resolution is lowered, depending on the model.

Format_7 Mode_1. By default and without further remapping use Format_7 Mode_1 for 2 x horizontal binning.



Figure 62: 2 x horizontal binning

4x horizontal binning combines 4 pixels to 1 pixel in a row.



Figure 63: 8 x horizontal binning

Note For Stingray F-201C only 2x horizontal binning is available.



The image appears horizontally compressed in this mode and does no longer show true aspect ratio.

If horizontal binning is activated the image may appear to be over-exposed and must eventually be corrected.

2 x full binning/4 x full binning/8 x full binning (F-201C only 2 x full binning)

F-504C has 2x/4x/8x full binning (no color binning)

If horizontal and vertical binning are combined, every 4 (16 or 64) pixels are consolidated into a single pixel. At first two (4 or 8) vertical pixels are put together and then combined horizontally.

- Light sensitivity** This increases light sensitivity by a total of a factor of 4 (16 or 64) and at the same time signal-to-noise separation is improved by about 6 (12 or 18) dB.
- Resolution** Resolution is reduced, depending on the model.
- Format_7 Mode_3** By default and without further remapping use Format_7 Mode_3 for 2 x full binning.

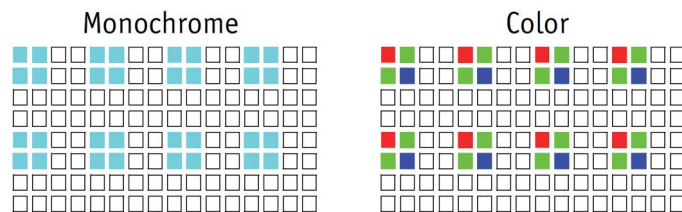

Figure 64: 2 x full binning

4x H+V binning combines 4 pixels in a row and 4 pixel in a column to 1 pixel.

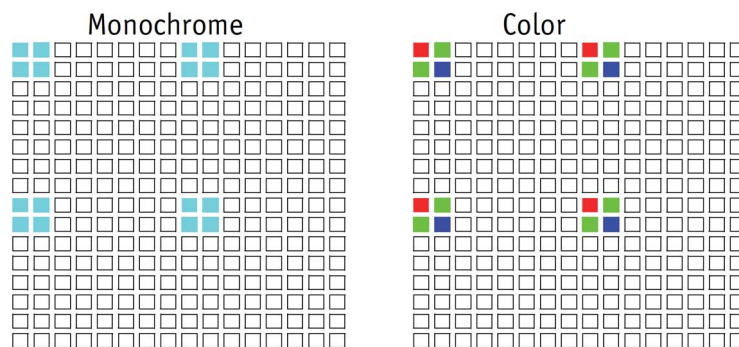

Figure 65: 8 x full binning (not F-201C, but F-504C)

Sub-sampling (Stingray monochrome and color models)

What is sub-sampling?

Sub-sampling is the process of skipping neighboring pixels (with the same color) while being read out from the CCD chip.

Which Stingray models have sub-sampling?

All Stingray models, both color and monochrome, have this feature.

Description of sub-sampling

Sub-sampling is used primarily for reducing the number of pixels and thus the amount of data while retaining the original image area angle and image brightness

Similar to binning mode the cameras support horizontal, vertical and H+Vsub-sampling mode.

Format_7 Mode_4 By default and without further remapping use Format_7 Mode_4 for

- B/W cameras: 2 out of 4 horizontal sub-sampling
- Color cameras: 2 out of 4 horizontal sub-sampling

The different sub-sampling patterns are shown below.

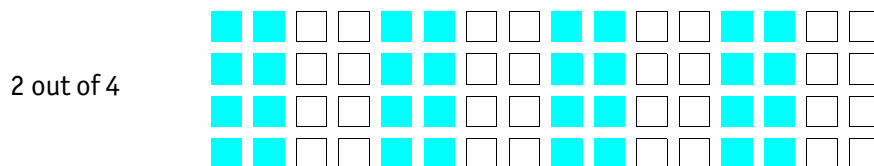

Figure 66: Horizontal sub-sampling 2 out of 4 (monochrome)

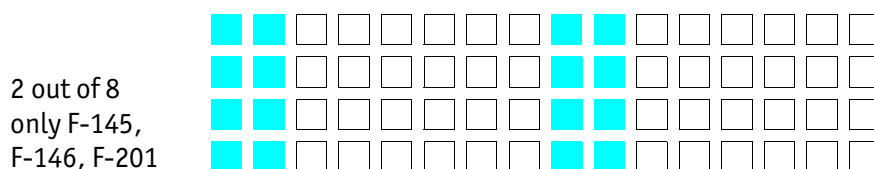

Figure 67: Horizontal sub-sampling 2 out of 8 (monochrome)

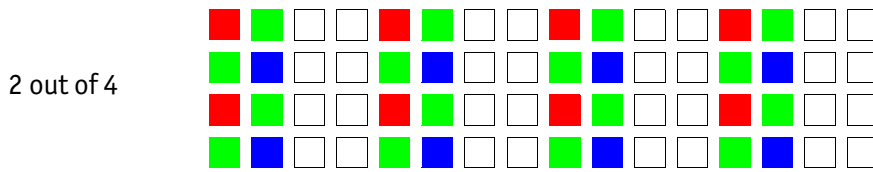

Figure 68: Horizontal sub-sampling 2 out of 4 (color)

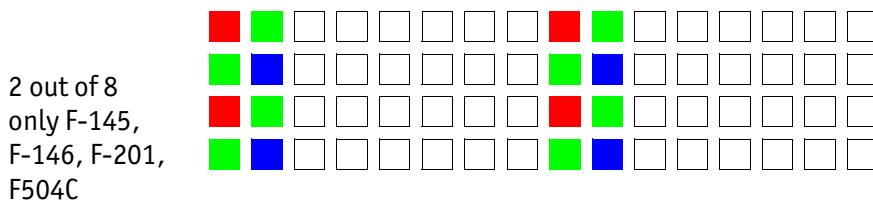

Figure 69: Horizontal sub-sampling 2 out of 8 (color)

Note

The image appears horizontally compressed in this mode and no longer exhibits a true aspect ratio.



Format_7 Mode_5 By default and without further remapping use Format_7 Mode_5 for

- monochrome cameras: 2 out of 4 vertical sub-sampling
- color cameras: 2 out of 4 vertical sub-sampling

The different sub-sampling patterns are shown below.

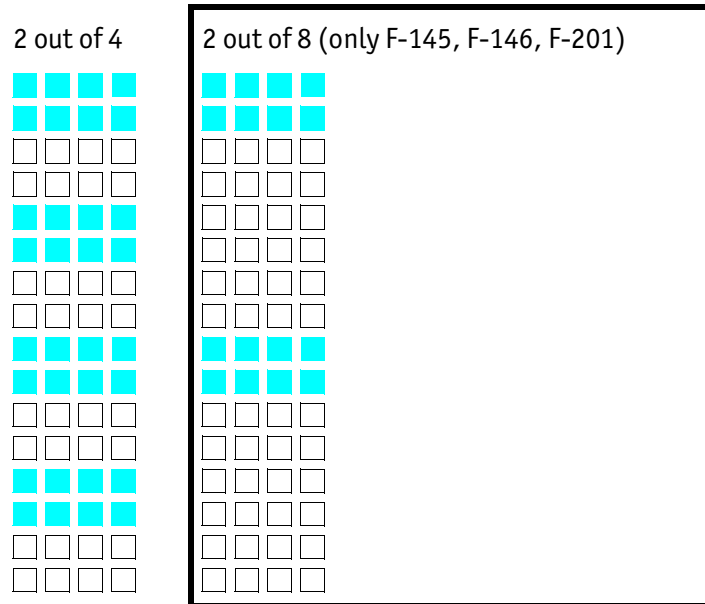

Figure 70: Vertical sub-sampling (monochrome)

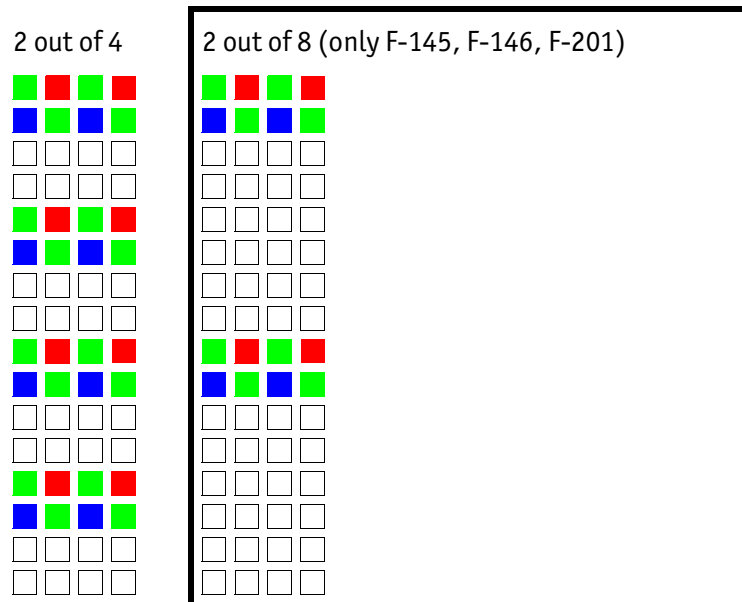

Figure 71: Vertical sub-sampling (color)

Note The image appears vertically compressed in this mode and no longer exhibits a true aspect ratio.



Format_7 Mode_6 By default and without further remapping use Format_7 Mode_6 for 2 out of 4 H+V sub-sampling

The different sub-sampling patterns are shown below.

2 out of 4 H+V sub-sampling

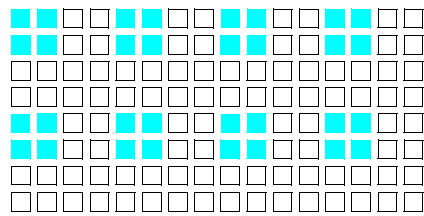

Figure 72: 2 out of 4 H+V sub-sampling (monochrome)

2 out of 8 H+V sub-sampling (only F-145, F-146, F-201)

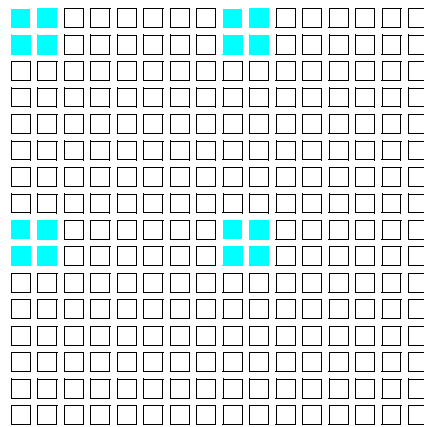

Figure 73: 2 out of 8 H+V sub-sampling (monochrome)

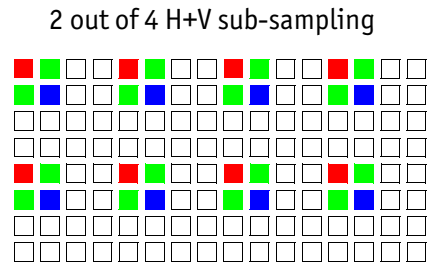

Figure 74: 2 out of 4 H+V sub-sampling (color)

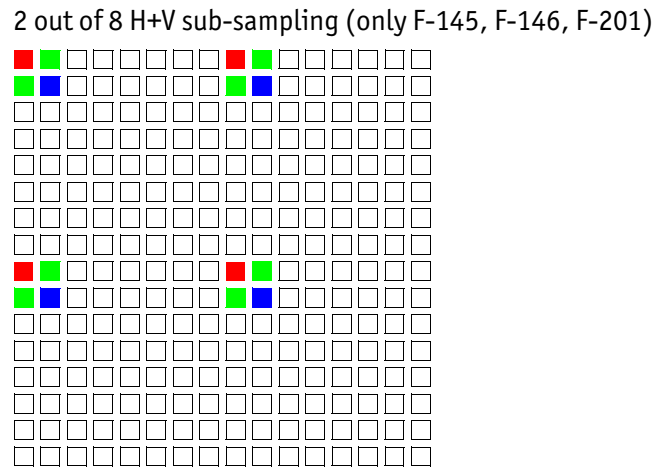

Figure 75: 2 out of 8 H+V sub-sampling (color)

Note

Changing sub-sampling modes involves the generation of new shading reference images due to a change in the image size.



Binning and sub-sampling access

The binning and sub-sampling modes described in the last two sections are only available as pure binning or pure sub-sampling modes. A combination of both is not possible.

Whereas there are some possible combinations, the number of available Format_7 modes is limited:

- Format_7 Mode_0 is fixed and cannot be changed.
- A maximum of 7 individual modes can be mapped to Format_7 Mode_1 to Mode_7 (see [Table 76](#) on page 164).
- Mappings can be stored via register (see chapter [Format_7 mode mapping](#) on page 315) and are uploaded automatically into the camera on camera reset.
- The default settings (per factory) in the Format_7 modes are listed in the following table.

Format_7	Stingray monochrome cameras	Format_7	Stingray color cameras	Format_7
Mode_0	full resolution, no binning, no sub-sampling		full resolution, no sub-sampling	
Mode_1	2 x horizontal binning		Only F-201C/F-504C: 2 x horizontal binning	
Mode_2	2 x vertical binning		Only F-201C/F-504C: 2 x vertical binning	
Mode_3	2 x full binning		Only F-201C/F-504C: 2 x full binning	
Mode_4	2 out of 4 horizontal sub-sampling		2 out of 4 horizontal sub-sampling	
Mode_5	2 out of 4 vertical sub-sampling		2 out of 4 vertical sub-sampling	
Mode_6	2 out of 4 full sub-sampling		2 out of 4 full sub-sampling	

Table 49: Default Format_7 binning and sub-sampling modes (per factory)

Note



- A combination of binning and sub-sampling modes is not possible. Use either binning or sub-sampling modes.
- The Format_ID numbers 0to27 in the binning / sub-sampling list on page 164 do not correspond to any of the Format_7 modes.

F7 modes according to IIDC 1394	Format_ID (see p322) Allied Vision modes		
F7M0 (no change)	0	0 x horizontal	0 x vertical
F7M1	1	2 x horizontal	
F7M2	2	4 x horizontal	
F7M3	3	8 x horizontal	2 x vertical
F7M4	4	0 x horizontal	
F7M5	5	2 x horizontal	
F7M6	6	4 x horizontal	4 x vertical (not F-201C, but F-504C)
F7M7	7	8 x horizontal	
	8	0 x horizontal	
	9	2 x horizontal	8 x vertical (not F-201C, but F-504C)
	10	4 x horizontal	
	11	8 x horizontal	
	12	0 x horizontal	2 out of 2 vertical
	13	2 x horizontal	
	14	4 x horizontal	
	15	8 x horizontal	2 out of 4 vertical
	16	---	
	17	2 out of 4 horizontal	
	18	2 out of 8 horizontal	2 out of 8 vertical (only F-145, F-146, F-201)
	19	2 out of 16 horizontal	
	20	2 out of 2 horizontal	
	21	2 out of 4 horizontal	sub-sampling (color and monochrome)
	22	2 out of 8 horizontal	
	23	2 out of 16 horizontal	
	24	2 out of 2 horizontal	sub-sampling (color and monochrome)
	25	2 out of 4 horizontal	
	26	2 out of 8 horizontal	
	27	2 out of 16 horizontal	

mapping of each of 27 modes to F7M1 to F7M7 possible

Figure 76: Mapping of possible Format_7 modes to F7M1 to F7M7

Note



Configuration

To configure this feature in an advanced register: See [Table 157](#) on page 322.

Quick parameter change timing modes

Stingray timing modes

- Frame rate or transfer rate is always constant (precondition: shutter < transfer time)
- The delay from shutter update until the change takes place: up to 3 frames. [Table 77](#) on page 165 demonstrates this behavior. It shows that the camera receives a shutter update command while the sensor is currently integrating (Sync is low) with shutter setting 400. The camera continues to integrate and this image is output with the next FVal. The shutter change command becomes effective with the next falling edge of sync and finally the image taken with shutter 200 is output with a considerable delay.
- Parameters that are sent to the camera faster than the maximum frame rate per second are stored in a FIFO and are activated in consecutive images.

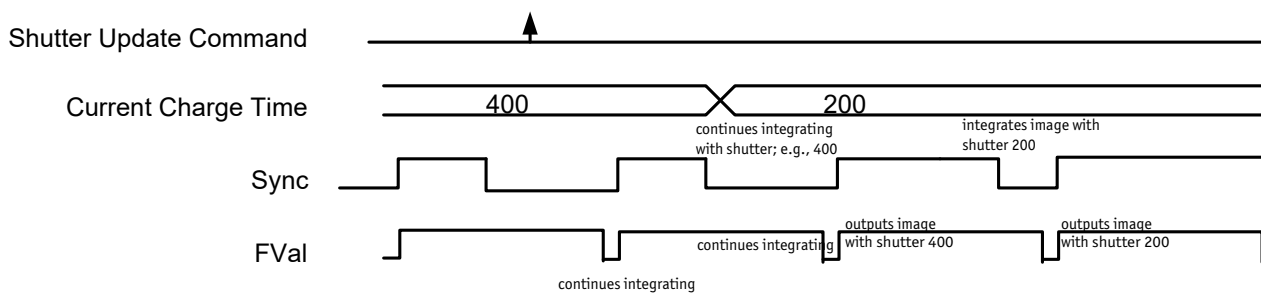

Figure 77: Former standard timing

Principally, a Stingray camera is not able to recognize how many parameter the user will change. Due to the fact that communication between host and camera is asynchronous, it may happen that one part of parameter changes is done in image $n+1$ and the other part is done in image $n+2$.

To optimize the transfer of parameter changes there is a new timing mode called Quick Format Change Mode, which effectively resets the current shutter.

Therefore, you can choose between the following update timing modes:

- Standard Parameter Update Timing
- Quick Format Change Mode

In the following you find a short description of both timing modes:

Standard Parameter Update Timing

The Standard Parameter Update Timing keeps the frame rate constant and does not create any gaps between two image transfers via bus (precondition: exposure (shutter) time must be smaller than transfer time).

- Frame rate / transfer rate is always constant (if shutter time < transfer time)
- Delay from shutter update until change takes place is always 2 frames (delay from update command reception by FPGA and not by microcontroller)
- Parameters sent to the camera faster than maximum frame rate are no longer stored in a FIFO. The last sent parameter will be activated for the next image. All others will be dropped. This ensures that the last image is shot with the last shutter setting.

Quick Format Change Mode (QFCM)

The Quick Format Change Mode creates gaps between two images. Current exposure is interrupted and the new exposure is started immediately with new parameters if a new shutter command is received.

- Frame rate / transfer rate can be *interrupted*, whenever FVal goes low after a reception of a new shutter command while Sync was low. This is shown in the diagram below
- Shutter will be interrupted, if the update command is received while camera integrates.
- Delay from shutter update until change takes place is always 1 frame.

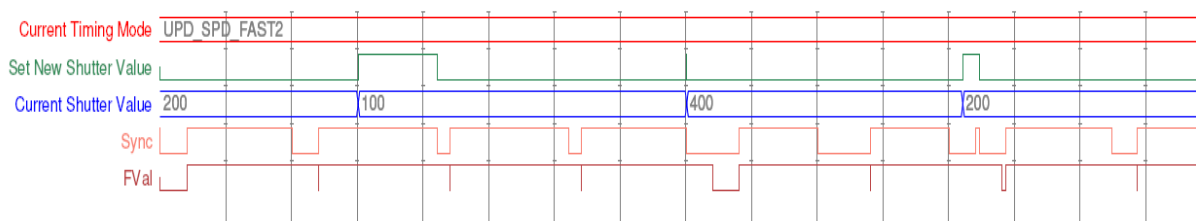

Figure 78: Quick Format Change Mode

How to transfer parameters to the camera

The following 3 variants of transferring the parameters are available:

Transfer mode	Advantage	Disadvantage
Encapsulated Update (begin/end)	<ul style="list-style-type: none"> • Easy to use (standard quad writes in camera register is possible) 	<ul style="list-style-type: none"> • One write access per register access
Parameter-List Update	<ul style="list-style-type: none"> • Only one write access for all parameters • Fastest host to camera transfer (faster than encapsulated mode, if more than 4 parameters are used) • Easy handling of parameter list 	<ul style="list-style-type: none"> • Not so easy to use (block writes) • Maximum 64 entries for parameter list
Standard Update (IIDC)	<ul style="list-style-type: none"> • Compliant with IIDC V1.31 	<ul style="list-style-type: none"> • Non deterministic change of parameters

Table 50: Comparison of 3 transfer modes

In the following section you find a short description of each variant:

Encapsulated Update (begin/end)

Encapsulated Update (begin/end) has the following characteristics:

- Host will set a parameter update begin flag in the camera (UpdActive Field in Register 0xF1000570, see [Table 154](#) on page 319).
- Host will send several parameters to the camera and signal end by resetting the flag.
- All parameters will become active for the same next image.
- Depending on timing mode, the camera
 - (standard Update): uses the previous parameters until the update flag is reset.
 - (Quick Format Change Mode): waits until the update flag is reset.

In the Encapsulated Update (begin/end) the exact sequence is as follows:

1. Parameter update begin (advanced feature register)
2. Standard IIDC register update (1 to N register) (standard feature register)
3. Parameter update end (advanced feature register)

The following section shows, how parameters determine camera timing behavior:

Fast Parameter Update Timing	Quick Format Change Mode
After the parameter update stop command, all changed parameters are valid for the available next image. Frame rate is constant.	<p>After the parameter update start command, current transfer is interrupted. An on-going exposure will be interrupted until the next parameter update stop command. Consecutively, exposure of the next image will start with new parameters.</p> <p>There may be a gap between two succeeding images but images are always transmitted completely.</p>

Table 51: Encapsulated Update (begin/end): comparison of standard timing and fast timing 2

If after the end of time-out (10 seconds after Quick Format Change Mode) no parameter update end is sent to the camera, all changes will become valid.

A new write event of parameter update begin starts time-out again.

Parameter-List Update

In the Parameter-List Update mode a complete list with IIDC addresses and values of up to 64 parameters is sent to the camera.

- Host sends a list with parameters to the camera (advanced feature space)
- Microcontroller processes that list
- All parameters will become active for the same image
- Dependent on timing mode, the camera will:
 - Standard Format Change Mode: use the previous parameters until the new parameter set is copied to the FPGA
 - Quick Format Change Mode (QFCM): waits until all parameters have been copied to the FPGA and may interrupt an already started integration for a new integration with the new settings

Example of parameter list:

Address	Value
0xF0F0081C	0x80000100
0xF0F00820	0x800000ac
0xF0F00818	0x82000001
to	to

Table 52: Example of parameter list

The exact sequence is:

Block-write of list to advanced feature address.

Note



This needs to be a functionality of the underlying software stack (e.g. FirePackage).

It may not be available for third party IIDC software stacks.

The following section shows, how parameters determine camera timing behavior:

Fast Parameter Update Timing	Quick Format Change Mode (QFCM)
After block write command is processed in the camera, all changed parameters are valid for the available next image. Frame rate is constant.	After transfer of the parameter list via block write, current transfer will be finished. An on-going exposure will be interrupted until the microcontroller has processed the list and copied it into the FPGA. Consecutively, exposure of the next image with new parameters is started. There may be a gap between two images.

Table 53: Parameter-List Update: comparison of standard timing and QFCM

Standard Update (IIDC)

In the Standard Update (IIDC) mode single parameter are sent to the camera.

- Standard Update (IIDC) shows the same behavior as Marlin.
- Parameter will be sent from host to camera and will be activated as soon as possible without interruption of the transfer.
- If the host updates more than one parameter (without block write), the parameters may become active in different images.
- Standard Update (IIDC) can be combined with the new parameter update timing modes.

The following section shows, how parameters determine camera timing behavior:

Fast Parameter Update Timing	Quick Format Change Mode (QFCM)
After sending a new parameter value, the changed parameter value is valid for the available next image. Frame rate is constant.	<p>After sending a new parameter value, the changed parameter value is valid for the available next image.</p> <p>On-going exposure will be interrupted and the image will be dropped.</p> <p>There may be a gap between two consecutive image transfers.</p>

Table 54: Standard Update (IIDC): comparison of Standard Format Change Mode and QFCM

Packed 12-Bit Mode

All Stingray cameras have Packed 12-Bit Mode. This means: two 12-bit pixel values are packed into 3 bytes instead of 4 bytes.

B/w cameras	Color cameras
Packed 12-Bit MONO camera mode	Packed 12-Bit RAW camera mode
SmartView: MONO12	SmartView: RAW12
Monochrome and raw mode have the same implementation.	

Table 55: Packed 12-Bit Mode

Note For data block packet format see [Table 38](#) on page 122.



For data structure see [Table 40](#) on page 124.

The color codings are implemented via Vendor Unique Color_Coding according to IIDC V1.31: COLOR_CODING_INQ @ 024hto033h, IDs=128-255)

See [Table 124](#) on page 283.

Mode	Color_Coding	ID
Packed 12-Bit MONO	ECCID_MONO12	ID=132
Packed 12-Bit RAW	ECCID_RAW12	ID=136

Table 56: Packed 12-Bit Mode: color coding

High SNR mode (High Signal Noise Ratio)

Note ---



Configuration
To configure this feature in an advanced register: See [Table 151](#) on page 316.

In this mode, the camera grabs and averages a set number of images to one output image with the same bit depth and brightness. This means that the camera will output an 8-bit averaged image when an 8-bit image format is selected.

Because of the fact that normally uncorrelated (photon-, amplifier-) noise dominates over correlated noise (fixed pattern noise), adding two images will double (6 dB) the gray levels but only increase the noise levels by $\sqrt{2}$ (3 dB).

This enhances both the dynamic range as well as the signal-to-noise ratio.

Consequently, adding 256 8-bit images will lead to a potential signal-to-noise enhancement of 24 dB or a resulting bit depth of 16 bit.

Note ---



- Only if the camera is idle, it can toggle this feature on/of. Idle means: no image acquisition, no trigger.
- Set grab count and activation of HighSNR in one single write access.

Note ---



- The averaged image is output at a lower frame rate roughly equivalent to $\text{fps_old}/N$, where N is the number of images averaged. In fact, due to camera internal conditions, and according to which format and mode settings are in use, it can vary slightly to be closer sometimes to $1/((N/\text{fps_old}) + T_{\text{shutter}})$. It is impractical to express in a formula or tables, across all camera models and modes. But these notes should be sufficient to help each user determine that the camera behaves as described.
- The potential SNR enhancement may be lower when using more than 8-bit original bit depth.
- Select 16-bit image format in order to take advantage of the full potential SNR and DNR (DyNamic Range) enhancements.
- For 8-bit video modes, the internal HSNR calculations are done with 14-bit.

Frame memory and deferred image transport

An image is normally captured and transported in consecutive steps. The image is taken, read out from the sensor, digitized, and sent over the IEEE 1394 bus.

Deferred image transport

As all Stingray cameras are equipped with built-in image memory, the order of events can be paused or delayed by using the deferred image transport feature.

Stingray cameras are equipped with 32 MB of RAM (Stingray F-504: 64 MB). The table below shows how many frames can be stored by each model. The memory operates according to the FIFO (first in, first out) principle. This makes addressing for individual images unnecessary.

Note For your camera's memory size and available frames to be stored, see chapter [Specifications](#) on page 59



Deferred image transport is especially useful for multi-camera applications:

Assuming several cameras acquire images concurrently, these images are stored in the built-in image memory of each camera. Until this memory is full, the limiting factor of available bus bandwidth, DMA- or ISO-channel is overcome.

Image transfer is controlled from the host computer by addressing individual cameras one after the other and reading out the desired number of images.

Note Configuration



To configure this feature in an advanced register: See [Table 140](#) on page 305.

HoldImg mode

By setting the HoldImg flag, transport of the image over the IEEE 1394 bus is stopped completely. All captured images are stored in the internal ImageFiFo. The camera reports the maximum possible number of images in the FiFoSize variable.

Note



- Pay attention to the maximum number of images that can be stored in FIFO. If you capture more images than the number in FIFOSize, the oldest images are overwritten.
- The extra SendImage flag is set to true to import the images from the camera. The camera sends the number of images set in the NumOfImages parameter.
- If NumOfImages is 0, all images stored in FIFO will be sent.
- If NumOfImages is not 0, the corresponding number of images will be sent.
- If the HoldImg field is set to false, all images in ImageFIFO will be deleted. No images will be sent.
- The last image in the FIFO will be corrupted, when simultaneously used as input buffer while being read out. In this case read out one image less than maximum buffer size.
- NumOfImages is incremented after an image was read out of the sensor and therefore stored into the onboard image FIFO.
- NumOfImages is decremented after the last isochronous packet of an image was handed over to the IEEE 1394 chipset of the camera.

The following screenshot shows the sequence of commands needed to work with deferred mode:

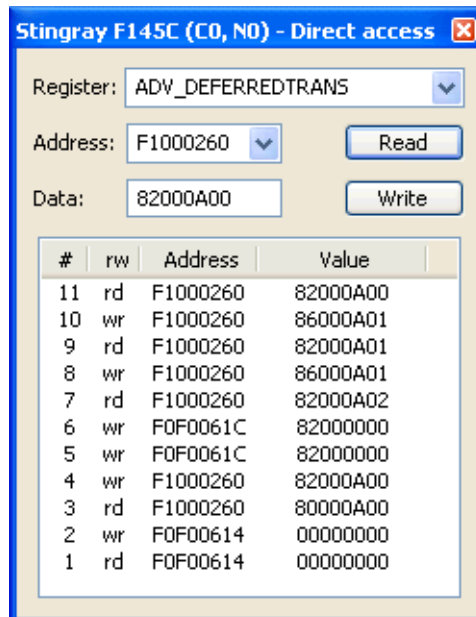

Figure 79: Example: Controlling deferred mode (SmartView - Direct Access; Stingray F-145C)

For a description of the commands see the following table:

#	rw	Address	Value	Description
11	rd	F1000260	82006900h	Check how many images are left in FIFO
10	wr	F1000260	86006901h	Read out the second image of FIFO
9	rd	F1000260	82006901h	Check how many images are left in FIFO
8	wr	F1000260	86006901h	Read out the first image of FIFO
7	rd	F1000260	82006902h	Check that two images are in FIFO
6	wr	F0F0061C	82000000h	Do second one-shot
5	wr	F0F0061C	82000000h	Do first one-shot
4	wr	F1000260	82000A00h	Switch deferred mode on
3	rd	F1000260	80000A00h	Check presence of deferred mode and FIFO size (0Ah → 10 frames)
2	wr	F0F00614	00000000h	Stop continuous mode of camera
1	rd	F0F00614	00000000h	Starting SmartView

Table 57: Example: Controlling deferred mode (SmartView - Direct Access; Stingray F-145C)

FastCapture mode

Note This mode can be activated only in Format_7.



By setting FastCapture to false, the maximum frame rate both for image acquisition and read out is associated with the packet size set in the BYTE_PER_PACKET register. The lower this value is, the lower the attainable frame rate is.

By setting FastCapture to true, all images are recorded at the highest possible frame rate, i.e., the setting above does not affect the frame rate for the image intake but only the read out. The speed of the image transport over the IEEE 1394 bus can be defined via the BytesPerPacket register. This mode is ideal for applications where a burst of images need to be recorded at the highest sensor speed but the output can be at a lower frame frequency to save bandwidth.

Similar to the HoldImg mode, captured images will be stored in the internal image FIFO, if the transport over the IEEE 1394 bus is slower than images are captured.

Color interpolation (BAYER demosaicing)

The color sensors capture the color information via so-called primary color (R-G-B) filters placed over the individual pixels in a BAYER mosaic layout. An effective BAYER → RGB color interpolation already takes place in all Stingray color version cameras.

In color interpolation a red, green, or blue value is determined for each pixel. An Allied Vision proprietary BAYER demosaicing algorithm is used for this interpolation (2x2), optimized for both sharpness of contours as well as reduction of false edge coloring.

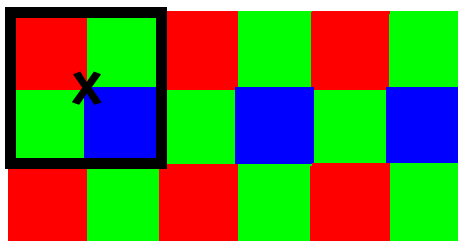

Figure 80: BAYER demosaicing (example of 2x2 matrix)

Color processing can be bypassed by using so-called RAW image transfer.

RAW mode is primarily used to:

- Save bandwidths on the IEEE 1394 bus.
- Achieve higher frame rates.
- Use different BAYER demosaicing algorithms on the PC (for all Stingray models the first pixel of the sensor is RED).

Note



If the PC does not perform BAYER to RGB post-processing, the monochrome image will be superimposed with a checkerboard pattern.

In color interpolation a red, green, or blue value is determined for each pixel. Only two lines are needed for this interpolation:

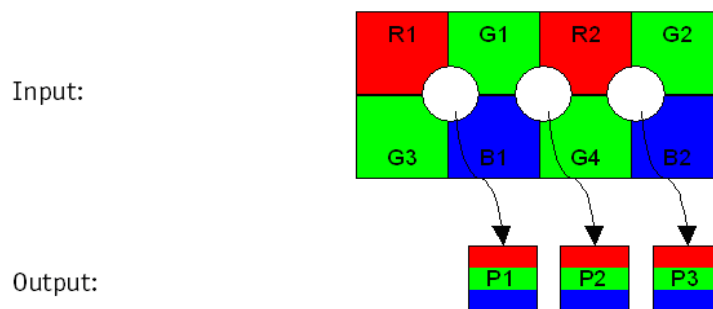

Figure 81: BAYER demosaicing (interpolation)

$$\begin{array}{lll}
 P1_{\text{red}} = R1 & P2_{\text{red}} = R2 & P3_{\text{red}} = R2 \\
 P1_{\text{green}} = \frac{G1 + G3}{2} & P2_{\text{green}} = \frac{G1 + G4}{2} & P3_{\text{green}} = \frac{G2 + G4}{2} \\
 P1_{\text{blue}} = B1 & P2_{\text{blue}} = B1 & P3_{\text{blue}} = B2
 \end{array}$$

Formula 4: BAYER demosaicing

Note



Please note that on the color camera, a wrongly colored border of one or two pixel wide forms on the left and right image borders. This is a consequence of BAYER demosaicing as the image width displayed on the color camera is not scaled down.

Sharpness

The Stingray color models are equipped with a four-step sharpness control, applying a discreet horizontal high pass in the Y channel as shown in the next five line profiles.

Sharpness 0, 1, 2, 3, 4 is calculated with the following scheme:

Sharpness value		Description			
0	<table border="1"><tr><td>+0.25</td><td>+0.5</td><td>+0.25</td></tr></table>	+0.25	+0.5	+0.25	Least sharp
+0.25	+0.5	+0.25			
1	<table border="1"><tr><td>+0.125</td><td>+0.75</td><td>+0.125</td></tr></table>	+0.125	+0.75	+0.125	Less sharp
+0.125	+0.75	+0.125			
2	<table border="1"><tr><td>0</td><td>1</td><td>0</td></tr></table>	0	1	0	Default: no sharpness applied in either direction
0	1	0			
3	<table border="1"><tr><td>-0.25</td><td>+1.5</td><td>-0.25</td></tr></table>	-0.25	+1.5	-0.25	Some sharp
-0.25	+1.5	-0.25			
4	<table border="1"><tr><td>-0.5</td><td>2</td><td>-0.5</td></tr></table>	-0.5	2	-0.5	Most sharp
-0.5	2	-0.5			

Table 58: Sharpness scheme

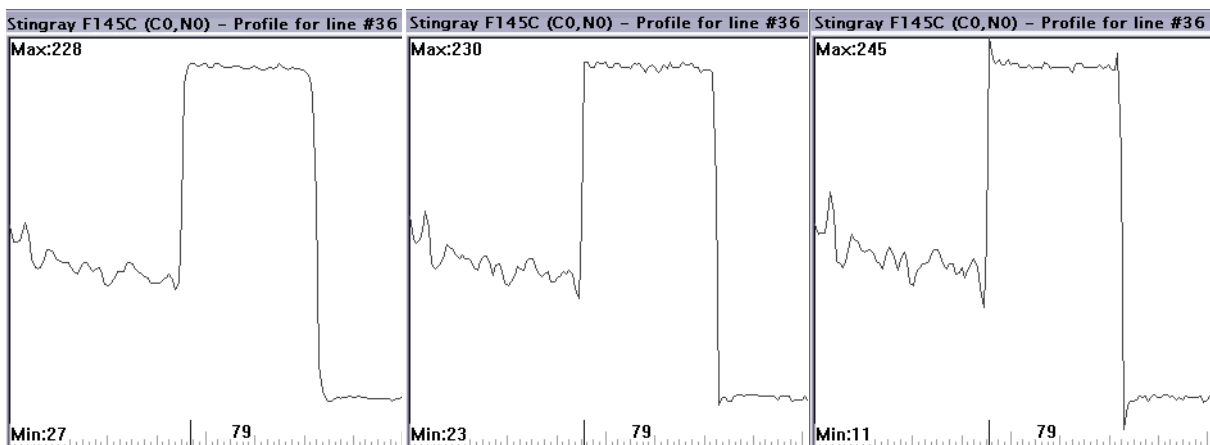

Figure 82: Sharpness: left: 2, middle: 3, right: 4

Note

Sharpness does not show any effect on Stingray color models in the Raw8, Raw12 and Raw16 format, because color processing is switched off in all Raw formats.

Note

Configuration

To configure this feature in feature control register: See [Table 122](#) on page 279.

Hue and saturation

Stingray CCD color models are equipped with hue and saturation registers.

The hue register at offset 810h allows the color of objects to be changed without altering the white balance, by ± 128 steps ($\pm 10^\circ$) from the nominal perception: $1/12.8^\circ$ per step; values from 0 to 256. Register value 128 means 0° . Use this setting to manipulate the color appearance after having carried out the white balance.

The saturation register at offset 814h allows the intensity of the colors to be changed between 0 and 200% in steps of $1/256$.

This means a setting of zero changes the image to black and white and a setting of 511 doubles the color intensity compared to the nominal one at 256.

Note

Configuration

To configure this feature in feature control register: See [Table 122](#) on page 279.

Note

Hue and saturation do not show any effect on Stingray color models in the Raw8 and Raw16 format, because color processing is switched off in all Raw formats.

Color correction

Why color correction?

The spectral response of a CCD is different of those of an output device or the human eye. This is the reason for the fact that perfect color reproduction is not possible. In each Stingray camera there is a factory setting for the color correction coefficients, see chapter [GretagMacbeth ColorChecker](#) on page 171.

Color correction is needed to eliminate the overlap in the color channels. This overlap is caused by the fact that:

- Blue light: is seen by the red and green pixels on the CCD
- Red light: is seen by the blue and green pixels on the CCD
- Green light: is seen by the red and blue pixels on the CCD

The color correction matrix subtracts out this overlap.

Color correction in Allied Vision cameras

In Allied Vision cameras the color correction is realized as an additional step in the process from the sensor data to color output.

Color correction is used to harmonize colors for the human eye.

Stingray cameras have the color correction matrix, enabling to manipulate the color-correction coefficients.

Color correction: formula

Before converting to the YUV format, color correction on all color models is carried out after BAYER demosaicing via a matrix as follows:

$$\begin{aligned}\text{Red} &= C_{rr} \times \text{Red} + C_{gr} \times \text{Green} + C_{br} \times \text{Blue} \\ \text{Green} &= C_{rg} \times \text{Red} + C_{gg} \times \text{Green} + C_{bg} \times \text{Blue} \\ \text{Blue} &= C_{rb} \times \text{Red} + C_{gb} \times \text{Green} + C_{bb} \times \text{Blue}\end{aligned}$$

Formula 5: Color correction

GretagMacbeth ColorChecker

Sensor-specific coefficients C_{xy} are scientifically generated to ensure that GretagMacbeth™ ColorChecker® colors are displayed with highest color fidelity and color balance.

These coefficients are stored in user set 0 and can not be overwritten (factory setting).

Changing color correction coefficients

You can change the color-correction coefficients according to your own needs. Changes are stored in the user settings.

Note

- A number of 1000 equals a color correction coefficient of 1.
- To obtain an identity matrix set values of 1000 for the diagonal elements and 0 for all others. As a result you get colors like in the RAW modes.
- The sums of all rows should be equal to each other. If not, you get tinted images.
- Color correction values range -1000 to +2000 and are signed 32 bit.
- In order for white balance to work properly ensure that the row sum equals 1000.
- Each row should sum up to 1000. If not, images are less or more colorful.
- The maximum row sum is limited to 2000.

Note

Configuration

To configure the color-correction coefficients in an advanced register: See [Table 147](#) on page 313.

To change the color-correction coefficients in SmartView, go to Adv3 tab.

Switch color correction on/off

Color correction can also be switched off in YUV mode:

Note

Configuration

To configure this feature in an advanced register: See [Table 147](#) on page 313.

Note

Color correction is deactivated in RAW mode.

Color conversion (RGB to YUV)

The conversion from RGB to YUV is made using the following formula:

$$\begin{aligned} Y &= 0.3 \times R + 0.59 \times G + 0.11 \times B \\ U &= -0.169 \times R - 0.33 \times G + 0.498 \times B + 128 \text{ (@ 8 bit)} \\ V &= 0.498 \times R - 0.420 \times G - 0.082 \times B + 128 \text{ (@ 8 bit)} \end{aligned}$$

Formula 6: RGB to YUV conversion

Note



- As mentioned above: Color processing can be bypassed by using so-called RAW image transfer.
- RGB → YUV conversion can be bypassed by using RGB8 format and mode. This is advantageous for edge color definition but needs more bandwidth (300% instead of 200% relative to monochrome or RAW consumption) for the transmission, so that the maximal frame frequency will drop.

Bulk Trigger

See chapter [chapter Trigger modes](#) on page 186 and the following pages.

Level Trigger

See Trigger Mode 1 in chapter [Trigger modes](#) on page 186.

Serial interface

All Stingray cameras are equipped with the SIO (serial input/output) feature as described in IIDC V1.31. This means that the Stingray's serial interface can be used as a general RS232 interface.

Data written to a specific address in the IEEE 1394 address range will be sent through the serial interface. Incoming data of the serial interface is put in a camera buffer and can be polled via simple read commands from this buffer. Controlling registers enable the settings of baud rates and the check of buffer sizes and serial interface errors.

Note



- Hardware handshaking is not supported.
- Typical PC hardware does not usually support 230400 bps or more.

Base address for the function is: F0F02100h.

To configure this feature in access control register (CSR):

Offset	Name	Field	Bit	Description
000h	SERIAL_MODE_REG	Baud_Rate	[0 to 7]	Baud rate setting WR: Set baud rate RD: Read baud rate 0: 300 bps 1: 600 bps 2: 1200 bps 3: 2400 bps 4: 4800 bps 5: 9600 bps 6: 19200 bps 7: 38400 bps 8: 57600 bps 9: 115200 bps 10: 230400 bps Other values reserved
		Char_Length	[8 to 15]	Character length setting WR: Set data length (7 or 8 bit) RD: Get data length 7: 7 bits 8: 8 bits Other values reserved
		Parity	[16 to 17]	Parity setting WR: Set parity RD: Get parity setting 0: None 1: Odd 2: Even
		Stop_Bit	[18 to 19]	Stop bits WR: Set stop bit RD: Get stop bit setting 0: 1 1: 1.5 2: 2
		---	[20 to 23]	Reserved
		Buffer_Size_Inq	[24 to 31]	Buffer Size (RD only) This field indicates the maximum size of receive/transmit data buffer. If this value=1, Buffer_Status_Control and SIO_Data_Register Char 1-3 should be ignored.

Table 59: Serial input/output control and status register (SIO CSR)

Offset	Name	Field	Bit	Description
0004h	SERIAL_CONTROL_REG	RE	[0]	Receive enable RD: Current status WR: 0: Disable 1: Enable
		TE	[1]	Transmit enable RD: Current status WR: 0: disable 1: Enable
		---	[2 to 7]	Reserved
	SERIAL_STATUS_REG	TDRD	[8]	Transmit data buffer ready Read only 0: not ready 1: ready
		---	[9]	Reserved
		RDRD	[10]	Receive data buffer ready Read only 0: not ready 1: ready
		---	[11]	Reserved
		ORER	[12]	Receive data buffer overrun error Read: current status WR: 0: no error (to clear status) 1: Ignored
		FER	[13]	Receive data framing error Read: current status WR: 0: no error (to clear status) 1: Ignored
		PER	[14]	Receive data parity error Read: current status WR: 0: no error (to clear status) 1: Ignored
	---	[15 to 31]	Reserved	

Table 59: Serial input/output control and status register (SIO CSR) (continued)

Offset	Name	Field	Bit	Description
008h	RECEIVE_BUFFER_STATUS_CONTRL	RBUF_ST	[0 to 7]	SIO receive buffer status RD: Number of bytes pending in receive buffer WR: Ignored
		RBUF_CNT	[8 to 15]	SIO receive buffer control RD: Number of bytes to be read from the receive FIFO WR: Number of bytes left for readout from the receive FIFO
		---	[16 to 31]	Reserved
00Ch	TRANSMIT_BUFFER_STATUS_CONTRL	TBUF_ST	[0 to 7]	SIO output buffer status RD: Space left in TX buffer WR: Ignored
		TBUF_CNT	[8 to 15]	SIO output buffer control RD: Number of bytes written to transmit FIFO WR: Number of bytes to transmit
		---	[16 to 31]	Reserved
010h to 0FFh		---		Reserved
100h	SIO_DATA_REGISTER	CHAR_0	[0 to 7]	Character_0 RD: Read character from receive buffer WR: Write character to transmit buffer
	SIO_DATA_REGISTER	CHAR_1	[8 to 15]	Character_1 RD: Read character from receive buffer+1 WR: Write character to transmit buffer+1
	SIO_DATA_REGISTER	CHAR_2	[16 to 23]	Character_2 RD: Read character from receive buffer+2 WR: Write character to transmit buffer+2
	SIO_DATA_REGISTER	CHAR_3	[24 to 31]	Character_3 RD: Read character from receive buffer+3 WR: Write character to transmit buffer+3
104h to 1FFh	SIO_DATA_REGISTER_ALIAS		[0 to 31]	Alias SIO_Data_Register area for block transfer

Table 59: Serial input/output control and status register (SIO CSR) (continued)

To read data:

1. Query RDRD flag (buffer ready?) and write the number of bytes the host wants to read to RBUF_CNT.
2. Read the number of bytes pending in the receive buffer RBUF_ST (more data in the buffer than the host wanted to read?) and the number of bytes left for reading from the receive FIFO in RBUF_CNT (host wanted to read more data than were in the buffer?).
3. Read received characters from SIO_DATA_REGISTER, beginning at char 0.
4. To input more characters, repeat from step 1.

To write data:

1. Query TDRD flag (buffer ready?) and write the number of bytes to send (copied from SIO register to transmit FIFO) to TBUF_CNT.
2. Read the available data space left in TBUF_ST (if the buffer can hold more bytes than are to be transmitted) and number of bytes written to transmit buffer in TBUF_CNT (if more data is to be transmitted than fits in the buffer).
3. Write character to SIO_DATA_REGISTER, beginning at char 0.
4. To output more characters, repeat from step 1.

Note

- Should you need detailed support to use this feature, please contact support at www.alliedvision.com/en/about-us/contact-us/technical-support-repair/-/rma.
- Allied Vision recommends the use of Hyperterminal™ or other communication programs to test the functionality of this feature. Alternatively, use SmartView to try out this feature.

Controlling image capture

- Shutter modes** The cameras support the SHUTTER_MODES specified in IIDC V1.31. For all models this shutter is a **global pipelined shutter**; meaning that all pixels are exposed to the light at the same moment and for the same time span.
- Pipelined** Pipelined means that the shutter for a new image can already happen, while the preceding image is transmitted.
- Continuous mode** In continuous modes, the shutter is opened shortly before the vertical reset happens, thus acting in a frame-synchronous way.
- External trigger** Combined with an external trigger, it becomes asynchronous in the sense that it occurs whenever the external trigger occurs. Individual images are recorded when an external trigger impulse is present. This ensures that even fast moving objects can be grabbed with no image lag and with minimal image blur.
- Software trigger** Stingray cameras know also a trigger initiated by software (status and control register **62Ch** on page 277 or in SmartView by **Trig/I0** tab, **Stop trigger** button).
- Camera I/O** The external trigger is fed as a TTL signal through **Pin 4** of the camera I/O connector.

Trigger modes

Stingray cameras support IIDC conforming Trigger_Mode_0 and Trigger_Mode_1 and special Trigger_Mode_15 (bulk trigger).

Trigger mode	also known as	Description
Trigger_Mode_0	Edge mode	Sets the shutter time according to the value set in the shutter (or extended shutter) register
Trigger_Mode_1	Level mode	Sets the shutter time according to the active low time of the pulse applied (or active high time in the case of an inverting input)
Trigger_Mode_15	Programmable mode	Is a bulk trigger , combining one external trigger event with continuous or one-shot or multi-shot internal trigger

Table 60: trigger modes

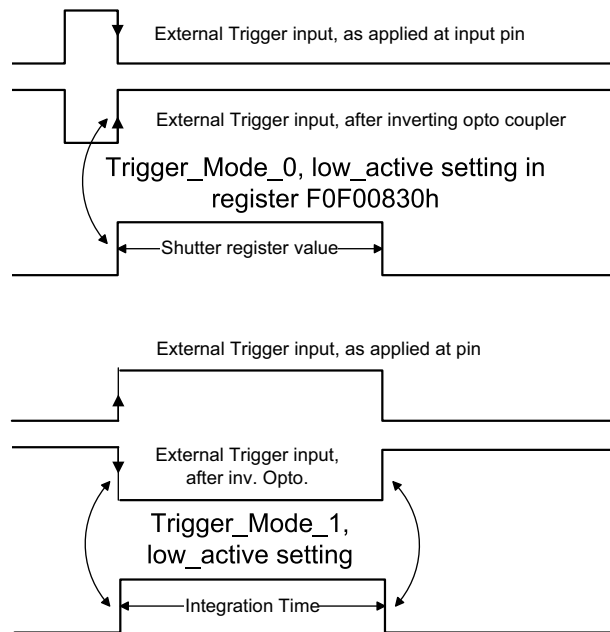

Figure 83: Trigger_Mode_0 and 1

Bulk trigger (Trigger_Mode_15)

Trigger_Mode_15 is an extension to the IIDC trigger modes. One external trigger event can be used to trigger a multitude of internal image intakes.

This is especially useful for:

- Grabbing exactly one image based on the first external trigger.
- Filling the camera's internal image buffer with one external trigger without overriding images.
- Grabbing an unlimited amount of images after one external trigger (surveillance).

The figure below illustrates this mode.

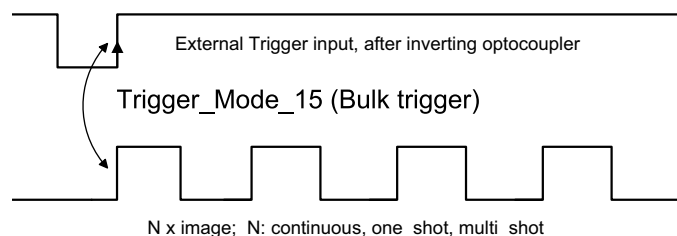

Figure 84: Trigger_Mode_15 (bulk trigger)

The functionality is controlled via bit [6] and bitgroup [12 to 15] of the following register:

Register	Name	Field	Bit	Description
0xF0F00830	TRIGGER_MODE	Presence_Inq	[0]	Presence of this feature: 0: N/A 1: Available
		Abs_Control	[1]	Absolute value control 0: Control with value in the Value field 1: Control with value in the Absolute value CSR If this bit = 1 the value in the Value field has to be ignored
		---	[2 to 5]	Reserved
		ON_OFF	[6]	Write: ON or OFF this feature Read: read a status 0: OFF 1: ON If this bit = 0, other fields will be read only
		Trigger_Polarity	[7]	Select trigger polarity (Except for software trigger) If Polarity_Inq is 1: Write to change polarity of the trigger input. Read to get polarity of the trigger input. If Polarity_Inq is 0: Read only. 0: Low active input 1: High active input
		Trigger_Source	[8 to 10]	Select trigger source Set trigger source ID from trigger source ID_Inq
		Trigger_Value	[11]	Trigger input raw signal value read only 0: Low 1: High
		Trigger_Mode	[12 to 15]	Trigger_Mode (Trigger_Mode_0 to 15)
		---	[16 to 19]	Reserved
		Parameter	[20 to 31]	Parameter for trigger function, if required (optional)

Table 61: Trigger_Mode_15 (Bulk trigger)

The screenshots below illustrate the use of Trigger_Mode_15 on a register level:

- Line #1 switches continuous mode off, leaving viewer in listen mode.
- Line #2 prepares 830h register for external trigger and Mode_15.

Left = continuous	Middle = one-shot	Right = multi-shot
Line #3 switches camera back to continuous mode. Only one image is grabbed precisely with the first external trigger. To repeat rewrite line three.	Line #3 toggles one-shot bit [0] of the one-shot register 61C so that only one image is grabbed, based on the first external trigger. To repeat rewrite line three.	Line #3 toggles multi-shot bit [1] of the one-shot register 61C so that Ah images are grabbed, starting with the first external trigger. To repeat rewrite line three.

Table 62: Description: using Trigger_Mode_15: continuous, one-shot, multi-shot

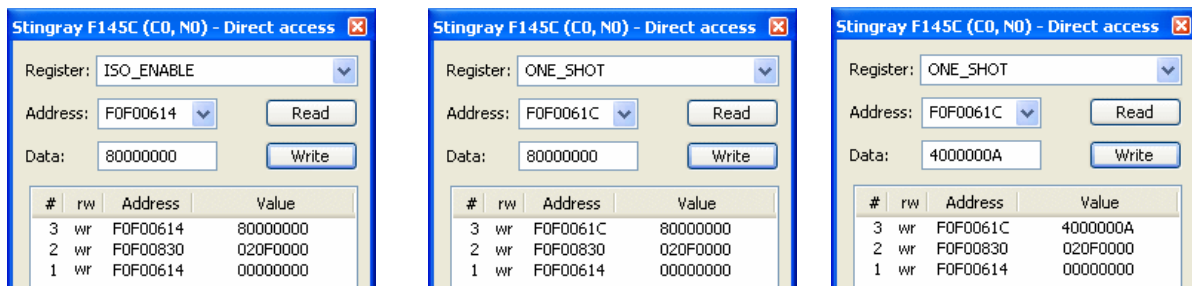

Figure 85: Using Trigger_Mode_15: continuous, one-shot, multi-shot

Note Shutter for the images is controlled by shutter register.



Trigger delay

As already mentioned earlier Stingray cameras feature various ways to delay image capture based on external trigger.

With IIDC V1.31 there is a standard CSR at register F0F00534/834h to control a delay up to FFFh x time base value.

The following table explains the inquiry register and the meaning of the various bits.

Register	Name	Field	Bit	Description
0xF0F00534	TRIGGER_DLY_INQUIRY	Presence_Inq	[0]	Indicates presence of this feature (read only)
		Abs_Control_Inq	[1]	Capability of control with absolute value
		---	[2]	Reserved
		One_Push_Inq	[3]	One-push auto mode (controlled automatically by the camera once)
		ReadOut_Inq	[4]	Capability of reading out the value of this feature
		On_Off_Inq	[5]	Capability of switching this feature ON and OFF
		Auto_Inq	[6]	Auto mode (controlled automatically by the camera)
		Manual_Inq	[7]	Manual mode (controlled by user)
		Min_Value	[8 to 19]	Minimum value for this feature
		Max_Value	[20 to 31]	Maximum value for this feature

Table 63: Trigger delay inquiry register

Register	Name	Field	Bit	Description
0xF0F00834	TRIGGER_DELAY	Presence_Inq	[0]	Presence of this feature: 0: N/A 1: Available
		Abs_Control	[1]	Absolute value control 0: Control with value in the Value field 1: Control with value in the Absolute value CSR If this bit = 1, the value in the Value field has to be ignored
		---	[2 to 5]	Reserved
		ON_OFF	[6]	Write: ON or OFF this feature Read: read a status 0: OFF 1: ON If this bit = 0, other fields will be read only.
		---	[7 to 19]	Reserved
		Value	[20 to 31]	Value If you write the value in OFF mode, this field will be ignored. If ReadOut capability is not available, then the read value will have no meaning.

Table 64: CSR: trigger delay

Trigger delay advanced register

In addition, the cameras have an advanced register that allows even more precise image capture delay after receiving a hardware trigger.

Register	Name	Field	Bit	Description
0xF1000400	TRIGGER_DELAY	Presence_Inq	[0]	Indicates presence of this feature (read only)
		---	[1 to 5]	Reserved
		ON_OFF	[6]	Trigger delay on/off
		---	[7 to 10]	Reserved
		DelayTime	[11 to 31]	Delay time in μ s

Table 65: Advanced CSR: trigger delay

The advanced register allows start of the integration to be delayed by maximum 2^{21} μ s, which is maximum 2.1 s after a trigger edge was detected.

Note



- Switching trigger delay to ON also switches external Trigger_Mode_0 to ON.
- This feature works with external Trigger_Mode_0 only.

Software trigger

A software trigger is an external signal that is controlled via a status and control register: **62Ch** on page 277: to activate software trigger set bit [0] to 1.

The behavior is different dependent on the trigger mode used:

- **Edge mode, programmable mode:** trigger is automatically reset (self cleared)
- **Level mode:** trigger is active until software trigger register is reset manually
 - ⇒ in advanced register **62Ch** on page 277: set bit [0] to 0
 - ⇒ in SmartView: **Trig/IO** tab, **Stop trigger** button

Debounce

Only for input ports:

There is an adjustable debounce time for trigger: separate for each input pin. The debounce time is a waiting period where no new trigger is allowed. This helps to set exact one trigger.

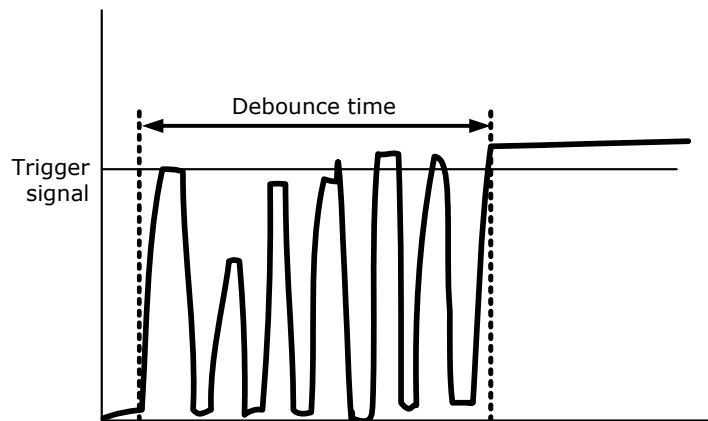

Figure 86: Example of debounce time for trigger

To set this feature in an advanced register: see chapter [Debounce time](#) on page 193.

To set this feature in SmartView: **Trig/IO** tab, **Input pins** table, **Debounce** column.

Debounce time

This register controls the debounce feature of the camera's input pins. The debounce time can be set for each available input separately.

General preconditions:

- Increment is 500 ns
- Debounce time is set in Time x 500 ns
- Minimum debounce time is 1.5 μ s \Rightarrow 3 x 500 ns
- Maximum debounce time is ~16 ms \Rightarrow $(2^{15}-1)$ x 500 ns

Offset	Name	Field	Bit	Description
0xF1000840	IO_INP_DEBOUNCE_1	Presence_Inq	[0]	Indicates presence of this feature (read only)
		---	[2 to 7]	Reserved
		Time	[8 to 31]	Debounce time in steps of 500 ns (24 bit) see examples above
0xF1000844		MinValue	[0 to 31]	Minimum debounce time
0xF1000848		MaxValue	[0 to 31]	Maximum debounce time
0xF100084C		---	[0 to 31]	Reserved
0xF1000850	IO_INP_DEBOUNCE_2			same as IO_INP_DEBOUNCE_1
0xF1000860	IO_INP_DEBOUNCE_3			same as IO_INP_DEBOUNCE_1
0xF1000870	IO_INP_DEBOUNCE_4			same as IO_INP_DEBOUNCE_1
0xF1000880				Reserved
0xF1000890				Reserved
0xF10008A0				Reserved
0xF10008B0				Reserved

Table 66: Advanced register: Debounce time for input ports

Note



- The camera corrects invalid values automatically.
- This feature is not stored in the user settings.

Exposure time (shutter) and offset

The exposure (shutter) time for continuous mode and Trigger_Mode_0 is based on the following formula:

Shutter register value x time base + offset

The register value is the value set in the corresponding IIDC 1.31 register (SHUTTER [81Ch]). This number lies between 1 and 4095.

The shutter register value is multiplied by the time base register value (see [Table 133](#) on page 294). The default value here is set to 20 μs.

A camera-specific offset is also added to this value. It is different for the camera models:

Exposure time offset, minimum exposure time

Camera model	Exposure time offset	Minimum exposure time	Effective minimum exposure time= Minimum exposure time + offset
Stingray F-033	27 μ s	4 μ s	4 μ s + 27 μ s = 31 μ s
Stingray F-046	27 μ s	4 μ s	4 μ s + 27 μ s = 31 μ s
Stingray F-080	45 μ s	4 μ s	4 μ s + 45 μ s = 49 μ s
Stingray F-125	21 μ s	4 μ s	4 μ s + 21 μ s = 25 μ s
Stingray F-145	70 μ s	4 μ s	4 μ s + 70 μ s = 74 μ s
Stingray F-145-30	37 μ s	4 μ s	4 μ s + 37 μ s = 41 μ s
Stingray F-146	35 μ s	4 μ s	4 μ s + 35 μ s = 39 μ s
Stingray F-201	44 μ s	4 μ s	4 μ s + 44 μ s = 48 μ s

Table 67: Camera-specific exposure time offset, minimum exposure time

Example: Stingray F-033

Camera	Register value	Time base (default)
Stingray F-033	100	20 μ s

Table 68: Register value and time base for Stingray F-033

The following example shows the relation between register value and exposure time in practice:

register value x time base = exposure time

100 x 20 μ s + 27 μ s = 2027 μ s exposure time

The minimum adjustable exposure time set by register is 4 μ s. → The real minimum exposure time of **Stingray F-033** is then:

4 μ s + 27 μ s = 31 μ s

Extended shutter

The exposure time for long-term integration of up to 67 seconds can be extended via the advanced register: EXTENDED_SHUTTER

Register	Name	Field	Bit	Description
0xF100020C	EXTD_SHUTTER	Presence_Inq	[0]	Indicates presence of this feature (read only)
		---	[1 to 5]	Reserved
		ExpTime	[6 to 31]	Exposure time in μ s

Table 69: Advanced register: Extended shutter

The longest exposure time, 3FFFFFFh, corresponds to 67.11 sec.

The lowest possible value of **ExpTime** is camera-specific (see [Table 67](#) on page 195).

Note



- Exposure times entered via the 81Ch register are mirrored in the extended register, but not vice versa.
- Longer integration times not only increase sensitivity, but may also increase some unwanted effects such as noise and pixel-to-pixel non-uniformity. Depending on the application, these effects may limit the longest usable integration time.
- Changes in this register have immediate effect, even when the camera is transmitting.
- Extended shutter becomes inactive after writing to a format/mode/frame rate register.
- Extended shutter setting will thus be overwritten by the normal time base/shutter setting after Stop/Start of **FireView** or **FireDemo**.

One-shot

Stingray cameras can record an image by setting the **one-shot bit** in the 61Ch register. This bit is automatically cleared after the image is captured. If the camera is placed in ISO_Enable mode (see chapter [ISO_Enable / free-run](#) on page 200), this flag is ignored.

If **one-shot mode** is combined with the external trigger, the **one-shot** command is used to arm it. The following screenshot shows the sequence of commands needed to put the camera into this mode. It enables the camera to grab exactly one image with an external trigger edge.

If there is no trigger impulse after the camera has been armed, **one-shot** can be cancelled by clearing the bit.

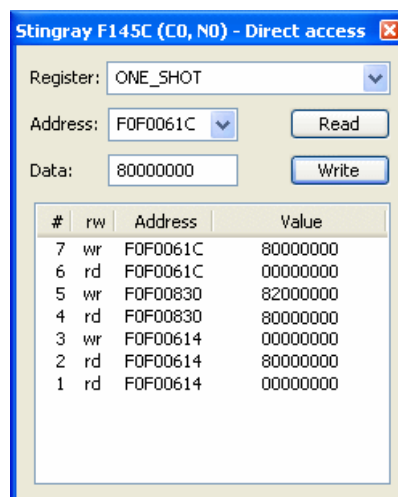

Figure 87: One-shot control (SmartView)

#	Read = rd Write = wr	Address	Value	Description
7	wr	F0F0061C	80000000	Do one-shot.
6	rd	F0F0061C	00000000	Read out one-shot register.
5	wr	F0F00830	82000000	Switch on external trigger mode 0.
4	rd	F0F00830	80000000	Check trigger status.
3	wr	F0F00614	00000000	Stop free-run.
2	rd	F0F00614	80000000	Check Iso_Enable mode (→free-run).
1	rd	F0F00614	00000000	This line is produced by SmartView.

Table 70: One-shot control: descriptions

One-shot command on the bus to start exposure

The following sections describe the time response of the camera using a single frame (one-shot) command. As set out in the IIDC specification, this is a software command that causes the camera to record and transmit a single frame.

The following values apply only when the camera is idle and ready for use. Full resolution must also be set.

Feature	Value
One-shot → microcontroller sync	≤ 150 μs (processing time in the microcontroller)
μC-Sync/ExSync → integration start	8 μs

Table 71: Values for one-shot

Microcontroller sync is an internal signal. It is generated by the microcontroller to initiate a trigger. This can either be a direct trigger or a release for ExSync if the camera is externally triggered.

End of exposure to first packet on the bus

After the exposure, the CCD sensor is read out; some data is written into the FRAME_BUFFER before being transmitted to the bus.

The time from the end of exposure to the start of transport on the bus is:

710 μs ± 62.5 μs

This time *jitters* with the cycle time of the bus (125 μs).

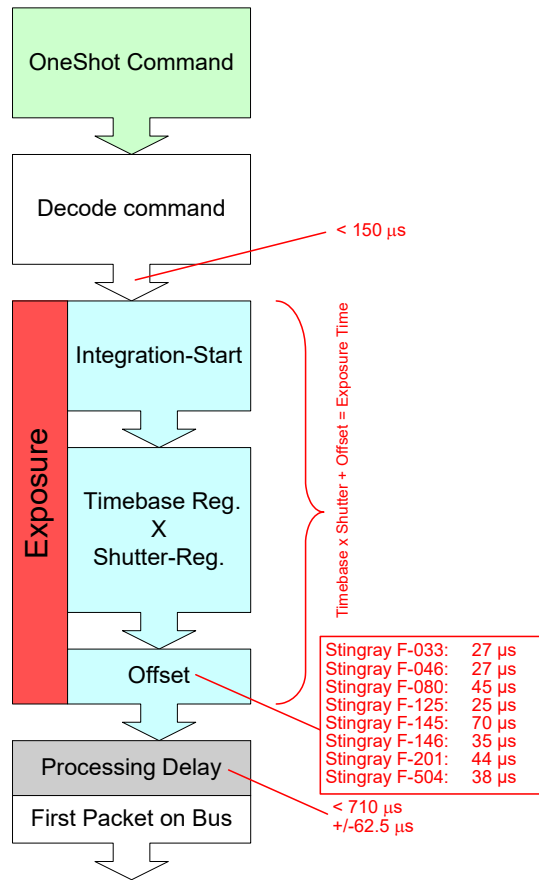

Figure 88: Data flow and timing after end of exposure

Multi-shot

Setting **multi-shot** and entering a quantity of images in **Count_Number** in the 61Ch register enables the camera to record a specified number of images.

The number is indicated in bits 16 to 31. If the camera is put into **ISO_Enable** mode (see chapter [ISO_Enable / free-run](#) on page 200), this flag is ignored and deleted automatically once all the images have been recorded.

If **multi-shot** mode is activated and the images have not yet all been captured, it can be cancelled by resetting the flag. The same result can be achieved by setting the number of images to **0**.

Multi-shot can also be combined with the external trigger in order to grab a certain number of images based on an external trigger. This is especially helpful in combination with the so-called **deferred mode** to limit the number of grabbed images to the FIFO size.

ISO_Enable / free-run

Setting the MSB (bit 0) in the 614h register (ISO_ENA) puts the camera into **ISO_Enable mode** or **Continuous_Shot (free-run)**. The camera captures an infinite series of images. This operation can be quit by deleting the **0** bit.

Asynchronous broadcast

The camera accepts asynchronous broadcasts. This involves asynchronous write requests that use node number 63 as the target node with no acknowledgment.

This makes it possible for all cameras on a bus to be triggered by software simultaneously; e.g., by broadcasting a **one-shot**. All cameras receive the **one-shot** command in the same IEEE 1394 bus cycle. This creates uncertainty for all cameras in the range of 125 μ s.

Inter-camera latency is described in chapter [Jitter at start of exposure](#) on page 202.

The following screenshot shows an example of broadcast commands sent with the Firedemo example of FirePackage:

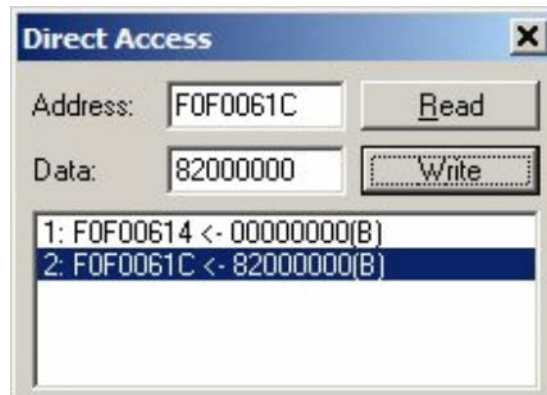

Figure 89: Broadcast one-shot

- Line 1 shows the broadcast command, which stops all cameras connected to the same IEEE 1394 bus. It is generated by holding the **Shift** key down while clicking on **Write**.
- Line 2 generates a **broadcast one_shot** in the same way, which forces all connected cameras to simultaneously grab one image.

Jitter at start of exposure

This section discusses the latency time that exists for all Stingray CCD models when either a hardware or software trigger is generated, until the actual image exposure starts.

Owing to the well-known fact that an **Interline Transfer CCD** sensor has both a light sensitive area and a separate storage area, it is common to interleave image exposure of a new frame and output that of the previous one. It makes continuous image flow possible, even with an external trigger.

The uncertain time delay before the start of exposure depends on the state of the sensor. A distinction is made as follows:

FVal is active → the sensor is reading out, the camera is busy

In this case, the camera must not change horizontal timing so that the trigger event is synchronized with the current horizontal clock. This introduces a maximum uncertainty, which is equivalent to the line time. The line time depends on the sensor used; and therefore, it can vary from model to model.

FVal is inactive → the sensor is ready, the camera is idle

In this case, the camera can resynchronize the horizontal clock to the new trigger event, leaving only a very short uncertainty time of the master clock period.

Model	Exposure start jitter (while FVal)	Exposure start jitter (while camera idle)
Stingray F-033	± 9.75 µs	± 1.30 µs
Stingray F-046	± 11.59 µs	± 1.30 µs
Stingray F-080	± 15.29 µs	± 3.33 µs
Stingray F-125	± 13.50 µs	± 3.10 µs
Stingray F-145	± 23.20 µs	± 5.40 µs
Stingray F-146	± 23.20 µs	± 5.87 µs
Stingray F-201	± 22.61 µs	± 3.56 µs
Stingray F-504	± 20.46 µs	± 5.81 µs

Table 72: Jitter at exposure start (no binning, no sub-sampling)

Note

Jitter at the beginning of an exposure has no effect on the length of exposure, i.e., it is always constant.



Sequence mode

Generally, all Stingray cameras enable certain image settings to be modified on the fly. For example, gain and shutter can be changed by the host computer by writing into the gain and shutter register even while the camera is running. An uncertainty of up to 3 images remains because normally the host does not know (especially with external trigger) when the next image will arrive.

Sequence mode is a different concept where the camera holds a set of different image parameters for a sequence of images. The parameter set is stored volatile in the camera for each image to be recorded. The advantage is that the camera can easily synchronize this parameter set with the images so that no uncertainty can occur. All Stingray cameras support 32 different sequence parameters.

Additionally, to the sequence mode known from Marlin cameras, the Stingray cameras have:

- Repeat counter per sequence item
- Incrementing list pointer on input status (on/off)
- Pointer reset (software command; on input pin)

Examples For a sequence of images, each image can be recorded with a different shutter or gain to obtain different brightness effects.

The image area (AOI) of a sequence of images can automatically be modified, thus creating a panning or sequential split screen effect.

The following registers can be modified to affect the individual steps of the sequence. Different configurations can be accessed via a footswitch that is connected to an input.

Mode	These registers can be modified within a sequence
All modes	Cur_V_Mode, Cur_V_Format, ISO_Channel, ISO_Speed, Brightness, White_Balance (color cameras only), Shutter, Gain, LUT, TestImage, Image-Mirror, HSNR, Output-Ctrl, ColorCorrection matrix (color cameras only), ISO-Channel, Shading-Ctrl, Sequence-Stepping Mode, SIS_UserValue
Fixed modes only	Cur_V_Frm_Rate
Format_7 only	Image_Position (AOI-Top, AOI-Left), Image_Size (AOI-Width, AOI-Height), Color_Coding_ID*, Binning*, Sub-Sampling*, Byte_Per_Packet *hidden in video formats and video modes

Table 73: Registers to be modified within a sequence

Note



Sequence mode requires special care if changing image size, Color_Coding_ID and frame rate related parameters. This is because these changes not only affect settings in the camera but also require corresponding settings in the receiving software in the PC.

Caution



- Incorrect handling may lead to **image corruption** or **loss of subsequent images**.
- Should you need detailed support to use this feature, please contact support at www.alliedvision.com/en/about-us/contact-us/technical-support-repair/-rma.

How is sequence mode implemented?

There is a FIFO (first in first out) memory for each of the IIDC V1.31 registers listed above. The depth of each FIFO is fixed to 32(dec) complete sets. Functionality is controlled by the following advanced registers.

Register	Name	Field	Bit	Description
0xF100220	SEQUENCE_CTRL	Presence_Inq	[0]	Indicates presence of this feature (read only)
		---	[1 to 4]	Reserved
		AutoRewind	[5]	
		ON_OFF	[6]	Enable/disable this feature
		SetupMode	[7]	Sequence setup mode
		---	[8 to 15]	Reserved
		MaxLength	[16 to 23]	Maximum possible length of a sequence (read only)
0xF100224	SEQUENCE_PARAM	---	[0 to 4]	Reserved
		ApplyParameters	[5]	Apply settings to selected image of sequence; auto reset
		---	[6 to 7]	Reserved
		SeqStepMode	[8 to 15]	Sequence stepping mode
		ImageRepeat	[16 to 23]	Image repeat counter
		ImageNo	[24 to 31]	Number of image within a sequence
0xF100228	SEQUENCE_STEP	Presence_Inq	[0]	Indicates presence of this feature (read only)
		---	[1 to 4]	Reserved
		PerformStep	[5]	Sequence is stepped one item forward
		PerformReset	[6]	Reset the sequence to start position
		---	[7 to 23]	Reserved
		SeqPosition	[24 to 31]	Get the current sequence position

Table 74: Advanced register: Sequence mode

Enabling this feature turns the camera into a special mode. This mode can be used to set up a bunch of parameter sets for up to **MaxLength** consecutive images.

Note

The sequence mode of the Stingray series behaves slightly different than the sequence mode of e.g., the Marlin series and implements some new controlling features. You may use a sequence with internal or external trigger and with the Deferred Transport feature.

Setup mode

The **SetupMode** flag allows you to set up a sequence while capturing images. Using this flag you get a visual feedback of the settings.

Set **SetupMode** flag when setting up the sequence and reset the flag before using the sequence.

Sequence step mode

The SeqMode field selects the signal source for stepping the sequence one parameter set further.

SeqMode description

Sequence mode	Description
0x80	This mode is the default sequence mode . With each image integration start the sequence is stepped one item further and the new parameter set becomes active for the next image.
0x82	Stepping of the sequence is controlled by a rising edge of an external signal . The new parameter set becomes active with the next integration start. When using this mode select the suitable input mode of the input lines.
0x84	Stepping of the sequence is controlled by a high level of an external signal . The new parameter set becomes active with the next integration start. When using this mode select the suitable input mode of the input lines.
Other mode	Choosing any other mode value automatically defaults to mode 0x80.

Table 75: Sequence mode description

Note

It is also possible, that a sequence consists of parameter sets with different sequence modes. This can be achieved by using the SeqMode and the ImageNo fields within the Sequence_Param register.

Sequence repeat counter

For each parameter set one can define an image repeat counter. Using the image repeat counter means that a parameter set can be used for n consecutive images before the next parameter set is applied.

Setting the **ImageRepeat** field to 0 has the same effect like setting this field to 1.

Manual stepping & reset

A sequence can be stepped further with a software command. To use manual stepping use stepping mode 0x82 or 0x84, but do not setup any input pin for external sequence stepping.

Every time the **PerformStep** flag is set the sequence will be stepped one parameter set further. Manual stepping observes the repeat counter also.

For some application it could be useful to reset the sequence during runtime. Simply set the **PerformReset** flag to one: the sequence starts over with the very first parameter set.

The following flow diagram shows how to set up a sequence.

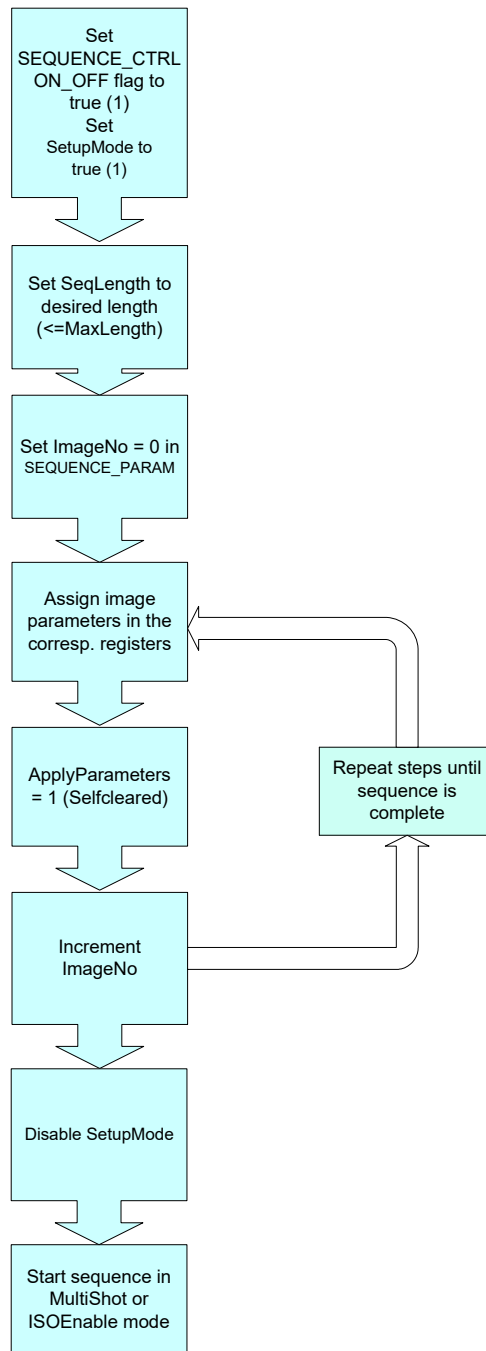

Figure 90: Sequence mode flow diagram

During sequencing, the camera obtains the required parameters image by image from the corresponding FIFOs (e.g. information for exposure time).

Which sequence mode features are available?

- Repeat one step of a sequence n times where n can be set by the variable **ImageRepeat** in SEQUENCE_PARAM.
- Define one or two hardware inputs in Input mode field of IO_INP_CTRL as:
 - Sequence step input (if two are set as input, they are AND gated) or
 - Sequence reset input

Note From now on:



- sequence step is I/O controlled sequence stepping mode
- sequence reset is I/O controlled sequence pointer reset

Setup mode

The **SetupMode** flag allows you to set up a sequence while capturing images. Using this flag you get a visual feedback of the settings. Set this flag when setting up the sequence and reset the flag before using the sequence.

I/O controlled sequence stepping mode

The I/O controlled sequence stepping mode can be done level controlled or edge controlled:

Level controlled	Edge controlled
<ul style="list-style-type: none"> • As long as the input is in high state the sequence pointer will be incremented from image to image. • Can be combined with Quick Format Change Modes. See chapter Standard Parameter Update Timing on page 166 and chapter Quick Format Change Mode (QFCM) on page 166. • Level change is asynchronous to image change. 	<ul style="list-style-type: none"> • A rising edge on the input will cause one pointer increment immediately. • Can be combined with Quick Format Change Modes. See chapter Standard Parameter Update Timing on page 166 and chapter Quick Format Change Mode (QFCM) on page 166.

Table 76: Description of sequence stepping control

The I/O controlled sequence stepping mode can be set for every single sequence entry. Thus, a sequence can be controlled in a very flexible manner.

I/O controlled sequence pointer reset

I/O controlled sequence pointer reset is always edge controlled. A rising edge on the input pin resets the pointer to the first entry.

I/O controlled sequence pointer reset can be combined with **Quick Format Change Modes**. See chapter **Standard Parameter Update Timing** on page 166 and chapter **Quick Format Change Mode (QFCM)** on page 166.

I/O controlled sequence stepping mode...

...and I/O controlled sequence pointer reset via software command:

Both sequence modes can be controlled via software command.

Points to pay attention to when working with a sequence

Note



- If more images are recorded than defined in **SeqLength**, the settings for the last image remain in effect.
- If **sequence** mode is canceled, the camera can use the FIFO for other tasks. For this reason, a sequence must be loaded back into the camera after **sequence** mode has been canceled.
- To repeat the sequence, stop the camera and send the **multi-shot** or **IsoEnable** command again. Each of these two commands resets the sequence.
- Using **single-shot** mode in combination with a sequence does not make sense, because **single-shot** mode restarts the sequence every time.
- The sequence may not be active when setting the AutoRewind flag. For this reason it is important to set the flag before the **multi-shot** or **IsoEnable** commands.
- If the sequence is used with the **deferred transport** feature, the number of images entered in **Seq_Length** may not be exceeded.

The following screenshot shows an example of a sequence for eight different image settings. It uses the **Firetool** program as graphical representation. Please note the changes in the shutter time; that creates descending image brightness, and the change in the image position; which creates a panning effect.

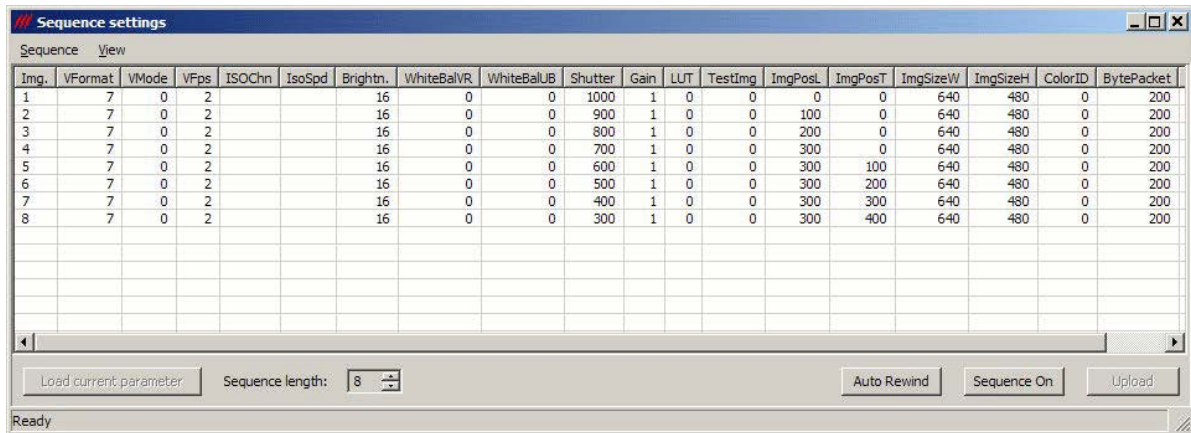

Img.	VFormat	VMode	VFps	ISOChn	IsoSpd	Brightn.	WhiteBalVR	WhiteBalUB	Shutter	Gain	LUT	TestImg	ImgPosL	ImgPosT	ImgSizeW	ImgSizeH	ColorID	BytePacket
1	7	0	2			16	0	0	1000	1	0	0	0	0	640	480	0	200
2	7	0	2			16	0	0	900	1	0	0	100	0	640	480	0	200
3	7	0	2			16	0	0	800	1	0	0	200	0	640	480	0	200
4	7	0	2			16	0	0	700	1	0	0	300	0	640	480	0	200
5	7	0	2			16	0	0	600	1	0	0	300	100	640	480	0	200
6	7	0	2			16	0	0	500	1	0	0	300	200	640	480	0	200
7	7	0	2			16	0	0	400	1	0	0	300	300	640	480	0	200
8	7	0	2			16	0	0	300	1	0	0	300	400	640	480	0	200

Figure 91: Example of sequence mode settings with Firetool

Instead of **Firetool** you also can use **SmartView** (Version 1.8.0 or greater), but image and transfer formats have to be unchanged (height, width, ColorID).

To open the **Sequence editor** in SmartView:

1. Click **Extras** → **Sequence dialog**

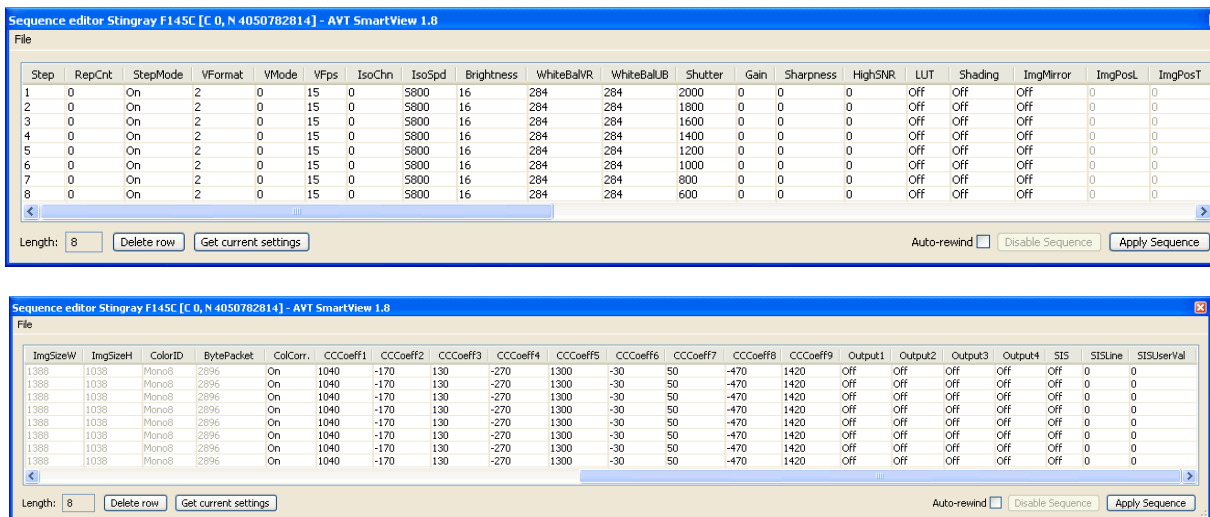

Sequence editor Stingray F145C [C 0, N 4050782814] - AVT SmartView 1.8

Step	RepCnt	StepMode	VFormat	VMode	VFps	IsoChn	IsoSpd	Brightness	WhiteBalVR	WhiteBalUB	Shutter	Gain	Sharpness	HighSNR	LUT	Shading	ImgMirror	ImgPosL	ImgPosT
1	0	On	2	0	15	0	S800	16	284	284	2000	0	0	0	Off	Off	Off	0	0
2	0	On	2	0	15	0	S800	16	284	284	1800	0	0	0	Off	Off	Off	0	0
3	0	On	2	0	15	0	S800	16	284	284	1600	0	0	0	Off	Off	Off	0	0
4	0	On	2	0	15	0	S800	16	284	284	1400	0	0	0	Off	Off	Off	0	0
5	0	On	2	0	15	0	S800	16	284	284	1200	0	0	0	Off	Off	Off	0	0
6	0	On	2	0	15	0	S800	16	284	284	1000	0	0	0	Off	Off	Off	0	0
7	0	On	2	0	15	0	S800	16	284	284	800	0	0	0	Off	Off	Off	0	0
8	0	On	2	0	15	0	S800	16	284	284	600	0	0	0	Off	Off	Off	0	0

Length: 8 | Delete row | Get current settings | Auto-rewind | Disable Sequence | Apply Sequence

Sequence editor Stingray F145C [C 0, N 4050782814] - AVT SmartView 1.8

ImgSizeW	ImgSizeH	ColorID	BytePacket	ColCorr.	CCCoeff1	CCCoeff2	CCCoeff3	CCCoeff4	CCCoeff5	CCCoeff6	CCCoeff7	CCCoeff8	CCCoeff9	Output1	Output2	Output3	Output4	SIS	SISLine	SISUserVal
1388	1038	Mono8	2896	On	1040	-170	130	-270	1300	-30	50	-470	1420	Off	Off	Off	Off	Off	0	0
1388	1038	Mono8	2896	On	1040	-170	130	-270	1300	-30	50	-470	1420	Off	Off	Off	Off	Off	0	0
1388	1038	Mono8	2896	On	1040	-170	130	-270	1300	-30	50	-470	1420	Off	Off	Off	Off	Off	0	0
1388	1038	Mono8	2896	On	1040	-170	130	-270	1300	-30	50	-470	1420	Off	Off	Off	Off	Off	0	0
1388	1038	Mono8	2896	On	1040	-170	130	-270	1300	-30	50	-470	1420	Off	Off	Off	Off	Off	0	0
1388	1038	Mono8	2896	On	1040	-170	130	-270	1300	-30	50	-470	1420	Off	Off	Off	Off	Off	0	0
1388	1038	Mono8	2896	On	1040	-170	130	-270	1300	-30	50	-470	1420	Off	Off	Off	Off	Off	0	0
1388	1038	Mono8	2896	On	1040	-170	130	-270	1300	-30	50	-470	1420	Off	Off	Off	Off	Off	0	0

Length: 8 | Delete row | Get current settings | Auto-rewind | Disable Sequence | Apply Sequence

Figure 92: SmartView: Extras → Sequence dialog

Changing the parameters within a sequence

To change the parameter set for one image, it is not necessary to modify the settings for the entire sequence. The image can simply be selected via the **ImageNo** field and then the corresponding IIDC V1.31 registers can be changed.

Points to pay attention to when changing the parameters

Note



- If the **ApplyParameters** flag is used when setting the parameters, all not-configured values are set to default values. As changing a sequence normally affects only the value of a specific register, and all other registers should not be changed, the **ApplyParameters** flag may not be used here.
- The values stored for individual images can no longer be read.
- If the camera is switched into **sequence mode**, the changes to the IIDC V1.31 registers for the image specified in **ImageNo** take immediate effect.
- Sequence mode requires special care if changing image size and frame rate related parameters. This is because these changes not only affect settings in the camera but also require corresponding settings in the receiving software in the PC (e.g. FirePackage).

Caution



- **Incorrect handling may lead to image corruption or loss of subsequent images.**
- Should you need detailed support to use this feature, please contact support at www.alliedvision.com/en/about-us/contact-us/technical-support-repair/-rma.

Secure image signature (SIS): definition and scenarios

Note



For all customers who know SIS from Marlin cameras:

- Stingray cameras have **additional SIS features**: AOI, exposure/gain, input/output state, index of sequence mode and serial number.
- Read carefully the following chapter.

SIS: Definition

Secure image signature (SIS) is the synonym for data that is saved with an image to improve or check image integrity.

All Stingray models can save:

- Cycle time (IEEE 1394 bus cycle time at the beginning of integration)
- Trigger counter (external trigger seen only)
- Frame counter (frames read out of the sensor)
- AOI (x, y, width, height)
- Exposure (shutter) and gain
- Input and output state on exposure start
- Index of sequence mode
- Serial number
- User value

into a selectable line position within the image. Furthermore the trigger counter and the frame counter are available as advanced registers to be read out directly.

SIS: Scenarios

The following scenarios benefit from this feature:

- Assuming camera runs in **continuous mode**, the check of monotonically changing bus cycle time is a simple test that no image was skipped or lost in the camera or subsequently in the image processing chain.
- In (synchronized) **multi-camera applications**, SIS can be used to identify those images, shot at the same moment in time.
- The cross-check of the frame counter of the camera against the frame counter of the host system also identifies any **skipped or lost images** during transmission.
- The cross-check of the trigger counter against the frame counter in the camera can identify a **trigger overrun** in the camera.
- AOI can be inserted in the image if it was set as a variable e.g. in a sequence.
- Exposure/gain scenario parameters can be inserted in the image if set as a variable in e.g. sequence mode to identify the imaging conditions.
- Inserting input and output state on exposure start can be helpful when working with input and output signals.
- Index of sequence mode is inserted automatically if SIS is used together with sequence mode.
- Serial number inserted in the image helps to document/identify the camera in e.g. multi-camera applications.

Note

FirePackage offers additional and independent checks to be performed for the purpose of image integrity. Details can be found in the respective documentation.

Note

More information:

The handling of the SIS feature is fully described in the chapter [Secure image signature \(SIS\)](#) on page 324.

Video formats, modes and bandwidth

The different Stingray models support different video formats, modes, and frame rates. These formats and modes are standardized in the IIDC (formerly DCAM) specification. Resolutions smaller than the maximum sensor resolution are generated from the center of the sensor and without binning.

Note



- The maximum frame rates can only be achieved with shutter settings lower than 1/framerate. This means that with default shutter time of 40 ms, a camera will not achieve frame rates higher than 25 fps. In order to achieve higher frame rates, please reduce the shutter time proportionally.
- For information on bit/pixel and byte/pixel for each color mode see [Table 105](#) on page 249.

Note



H-binning means horizontal binning.

V-binning means vertical binning.

Full binning (H+V) means horizontal + vertical binning

2 x binning means: 2 neighboring pixels are combined.

4 x binning means: 4 neighboring pixels are combined.

Stingray F-033B/F-033C (including board level variants)

Note

The following tables assume that bus speed is 800 Mb/s. With lower bus speeds (e.g. 400, 200 or 100 Mb/s) not all frame rates may be achieved.

Note

The following Format_7 tables show default Format_7 modes without Format_7 mode mapping.

For information on Format_7 mode mapping:

- See chapter [Mapping of possible Format_7 modes to F7M1 to F7M7](#) on page 164
- See chapter [Format_7 mode mapping](#) on page 322

Format Mode	Resolution	Color mode	60 fps	30 fps	15 fps	7.5 fps	3.75 fps	1.875 fps
0	0	160 x 120	YUV444					
	1	320 x 240	YUV422	x	x	x	x	x
	2	640 x 480	YUV411	x	x	x	x	x
	3	640 x 480	YUV422	x	x	x	x	x
	4	640 x 480	RGB8	x	x	x	x	x
	5	640 x 480	Mono8	x x*	x x*	x x*	x x*	x x*
	6	640 x 480	Mono16	x	x	x	x	x

Table 77: Video fixed formats Stingray F-033B/F-033C

*: Color camera outputs Mono8 interpolated image.



Frame rates with shading are only achievable with IEEE 1394b (S800).

Note

[Table 78](#) on page 217 shows default Format_7 modes without Format_7 mode mapping.

For information on Format_7 mode mapping:

- See chapter [Mapping of possible Format_7 modes to F7M1 to F7M7](#) on page 164
- See chapter [Format_7 mode mapping](#) on page 322

Format	Mode	Resolution	Color mode	Maximal S800 frame rates for Format_7 modes	
7	0	656 x 492	Mono8	84 fps	
			Mono12	84 fps	
			Mono16	84 fps	
		656 x 492	YUV411	84 fps	
			YUV422,Raw16	84 fps	
			Mono8,Raw8	84 fps	
			RGB8	67 fps	
	Raw12	84 fps			
	1	328 x 492	Mono8	84 fps	2x H-binning
			Mono12	84 fps	2x H-binning
			Mono16	84 fps	2x H-binning
	2	656 x 246	Mono8	149 fps	2x V-binning
Mono12			149 fps	2x V-binning	
Mono16			149 fps	2x V-binning	
3	328 x 246	Mono8	149 fps	2x H+V binning	
		Mono12	149 fps	2x H+V binning	
		Mono16	149 fps	2x H+V binning	
4	328 x 492	Mono8	84 fps	2 out of 4 H-sub-sampling	
		Mono12	84 fps	2 out of 4 H-sub-sampling	
		Mono16	84 fps	2 out of 4 H-sub-sampling	
	328 x 492	YUV411	84 fps	2 out of 4 H-sub-sampling	
		YUV422,Raw16	84 fps	2 out of 4 H-sub-sampling	
		Mono8,Raw8	84 fps	2 out of 4 H-sub-sampling	
		RGB8	84 fps	2 out of 4 H-sub-sampling	
Raw12	84 fps	2 out of 4 H-sub-sampling			
5	656 x 246	Mono8	108 fps	2 out of 4 V-sub-sampling	
		Mono12	108 fps	2 out of 4 V-sub-sampling	
		Mono16	108 fps	2 out of 4 V-sub-sampling	
	656 x 246	YUV411	108 fps	2 out of 4 V-sub-sampling	
		YUV422,Raw16	108 fps	2 out of 4 V-sub-sampling	
		Mono8,Raw8	108 fps	2 out of 4 V-sub-sampling	
		RGB8	108 fps	2 out of 4 V-sub-sampling	
Raw12	108 fps	2 out of 4 V-sub-sampling			
6	328 x 246	Mono8	108 fps	2 out of 4 H+V sub-sampling	
		Mono12	108 fps	2 out of 4 H+V sub-sampling	
		Mono16	108 fps	2 out of 4 H+V sub-sampling	
	328 x 246	YUV411	108 fps	2 out of 4 H+V sub-sampling	
		YUV422,Raw16	108 fps	2 out of 4 H+V sub-sampling	
		Mono8,Raw8	108 fps	2 out of 4 H+V sub-sampling	
		RGB8	108 fps	2 out of 4 H+V sub-sampling	
Raw12	108 fps	2 out of 4 H+V sub-sampling			

Table 78: Video Format_7 default modes Stingray F-033B/F-033C

Stingray F-046B/F-046C (including board level variants)

Format	Mode	Resolution	Color mode	60 fps	30 fps	15 fps	7.5 fps	3.75 fps	1.875 fps
0	0	160 x 120	YUV444						
	1	320 x 240	YUV422	x	x	x	x	x	x
	2	640 x 480	YUV411	x	x	x	x	x	x
	3	640 x 480	YUV422	x	x	x	x	x	x
	4	640 x 480	RGB8	x	x	x	x	x	x
	5	640 x 480	Mono8	x x*	x x*	x x*	x x*	x x*	x x*
	6	640 x 480	Mono16	x	x	x	x	x	x

Table 79: Video fixed formats Stingray F-046B/F-046C

*: Color camera outputs Mono8 interpolated image.

 Frame rates with shading are only achievable with IEEE 1394b (S800).

Note



The following table shows default Format_7 modes without Format_7 mode mapping.

For information on Format_7 mode mapping to

- to see chapter [Mapping of possible Format_7 modes to F7M1 toF7M7](#) on page 164
- to see chapter [Format_7 mode mapping](#) on page 322

Format	Mode	Resolution	Color mode	Maximal S800 frame rates for Format_7 modes	
7	0	780 x 580	Mono8	61 fps	
			Mono12	61 fps	
			Mono16	61 fps	
		780 x 580	YUV411	61 fps	
			YUV422,Raw16	61 fps	
			Mono8,Raw8	61 fps	
			RGB8	48 fps	
	Raw12	61 fps			
	1	388 x 580	Mono8	61 fps	2x H-binning
			Mono12	61 fps	2x H-binning
			Mono16	61 fps	2x H-binning
	2	780 x 290	Mono8	111 fps	2x V-binning
Mono12			111 fps	2x V-binning	
Mono16			111 fps	2x V-binning	
3	388 x 290	Mono8	111 fps	2x H+V binning	
		Mono12	111 fps	2x H+V binning	
		Mono16	111 fps	2x H+V binning	
4	388 x 580	Mono8	61 fps	2 out of 4 H-sub-sampling	
		Mono12	61 fps	2 out of 4 H-sub-sampling	
		Mono16	61 fps	2 out of 4 H-sub-sampling	
	388 x 580	YUV411	61 fps	2 out of 4 H-sub-sampling	
		YUV422,Raw16	61 fps	2 out of 4 H-sub-sampling	
		Mono8,Raw8	61 fps	2 out of 4 H-sub-sampling	
		RGB8	61 fps	2 out of 4 H-sub-sampling	
Raw12	61 fps	2 out of 4 H-sub-sampling			
5	780 x 290	Mono8	79 fps	2 out of 4 V-sub-sampling	
		Mono12	79 fps	2 out of 4 V-sub-sampling	
		Mono16	79 fps	2 out of 4 V-sub-sampling	
	780 x 290	YUV411	79 fps	2 out of 4 V-sub-sampling	
		YUV422,Raw16	79 fps	2 out of 4 V-sub-sampling	
		Mono8,Raw8	79 fps	2 out of 4 V-sub-sampling	
		RGB8	79 fps	2 out of 4 V-sub-sampling	
Raw12	79 fps	2 out of 4 V-sub-sampling			
6	388 x 290	Mono8	79 fps	2 out of 4 H+V sub-sampling	
		Mono12	79 fps	2 out of 4 H+V sub-sampling	
		Mono16	79 fps	2 out of 4 H+V sub-sampling	
	388 x 290	YUV411	79 fps	2 out of 4 H+V sub-sampling	
		YUV422,Raw16	79 fps	2 out of 4 H+V sub-sampling	
		Mono8,Raw8	79 fps	2 out of 4 H+V sub-sampling	
		RGB8	79 fps	2 out of 4 H+V sub-sampling	
Raw12	79 fps	2 out of 4 H+V sub-sampling			

Table 80: Video Format_7 default modes Stingray F-046B/F-046C

Stingray F-080B/F-080C (including board level variants)

Format	Mode	Resolution	Color mode	60 fps	30 fps	15 fps	7.5 fps	3.75 fps	1.875 fps
0	0	160 x 120	YUV444						
	1	320 x 240	YUV422	x	x	x	x	x	x
	2	640 x 480	YUV411		x	x	x	x	x
	3	640 x 480	YUV422		x	x	x	x	x
	4	640 x 480	RGB8		x	x	x	x	x
	5	640 x 480	Mono8		xx*	xx*	xx*	xx*	xx*
	6	640 x 480	Mono16		x	x	x	x	x
1	0	800 x 600	YUV422		x	x	x	x	
	1	800 x 600	RGB8		x	x	x		
	2	800 x 600	Mono8		xx*	xx*	xx*		
	3	1024 x 768	YUV422		x	x	x	x	x
	4	1024 x 768	RGB8		x	x	x	x	x
	5	1024 x 768	Mono8		xx*	xx*	xx*	xx*	xx*
	6	800 x 600	Mono16		x	x	x	x	
	7	1024 x 768	Mono16		x	x	x	x	x

Table 81: Video fixed formats Stingray F-080B/F-080C

*: Color camera outputs Mono8 interpolated image.

 Frame rates with shading are only achievable with IEEE 1394b (S800).

Note



The following table shows default Format_7 modes without Format_7 mode mapping.

For information on Format_7 mode mapping to

- to see chapter [Mapping of possible Format_7 modes to F7M1 to F7M7](#) on page 164
- to see chapter [Format_7 mode mapping](#) on page 322

Format	Mode	Resolution	Color mode	Maximal S800 frame rates for Format_7 modes	
7	0	1032 x 776	Mono8 Mono12 Mono16	31 fps 31 fps 31 fps	
		1032 x 776	YUV411 YUV422,Raw16 Mono8,Raw8 RGB8 Raw12	31 fps 31 fps 31 fps 27 fps 31 fps	
		516 x 776	Mono8	31 fps	2x H-binning
			Mono12	31 fps	2x H-binning
			Mono16	31 fps	2x H-binning
		1032 x 388	Mono8	53 fps	2x V-binning
			Mono12	53 fps	2x V-binning
Mono16	53 fps		2x V-binning		
516 x 388	Mono8	53 fps	2x H+V binning		
	Mono12	53 fps	2x H+V binning		
	Mono16	53 fps	2x H+V binning		
4	516 x 776	Mono8	31 fps	2 out of 4 H-sub-sampling	
		Mono12	31 fps	2 out of 4 H-sub-sampling	
		Mono16	31 fps	2 out of 4 H-sub-sampling	
		YUV411	31 fps	2 out of 4 H-sub-sampling	
		YUV422,Raw16	31 fps	2 out of 4 H-sub-sampling	
		Mono8,Raw8	31 fps	2 out of 4 H-sub-sampling	
		RGB8	31 fps	2 out of 4 H-sub-sampling	
Raw12	31 fps	2 out of 4 H-sub-sampling			
5	1032 x 388	Mono8	39 fps	2 out of 4 V-sub-sampling	
		Mono12	39 fps	2 out of 4 V-sub-sampling	
		Mono16	39 fps	2 out of 4 V-sub-sampling	
		YUV411	39 fps	2 out of 4 V-sub-sampling	
		YUV422,Raw16	39 fps	2 out of 4 V-sub-sampling	
		Mono8,Raw8	39 fps	2 out of 4 V-sub-sampling	
		RGB8	39 fps	2 out of 4 V-sub-sampling	
Raw12	39 fps	2 out of 4 V-sub-sampling			
6	516 x 388	Mono8	39 fps	2 out of 4 H+V-sub-sampling	
		Mono12	39 fps	2 out of 4 H+V-sub-sampling	
		Mono16	39 fps	2 out of 4 H+V-sub-sampling	
		YUV411	39 fps	2 out of 4 H+V-sub-sampling	
		YUV422,Raw16	39 fps	2 out of 4 H+V-sub-sampling	
		Mono8,Raw8	39 fps	2 out of 4 H+V-sub-sampling	
		RGB8	39 fps	2 out of 4 H+V-sub-sampling	
Raw12	39 fps	2 out of 4 H+V sub-sampling			

Table 82: Video Format_7 default modes Stingray F-080B/F-080C

Stingray F-125B/F-125C (including board level variants)

Format	Mode	Resolution	Color mode	60 fps	30 fps	15 fps	7.5 fps	3.75 fps	1.875 fps
0	0	160 x 120	YUV444						
	1	320 x 240	YUV422	x	x	x	x	x	x
	2	640 x 480	YUV411		x	x	x	x	x
	3	640 x 480	YUV422		x	x	x	x	x
	4	640 x 480	RGB8		x	x	x	x	x
	5	640 x 480	Mono8		xx*	xx*	xx*	xx*	xx*
	6	640 x 480	Mono16		x	x	x	x	x
1	0	800 x 600	YUV422		x	x	x	x	
	1	800 x 600	RGB8		x	x	x		
	2	800 x 600	Mono8		xx*	xx*	xx*		
	3	1024 x 768	YUV422		x	x	x	x	x
	4	1024 x 768	RGB8			x	x	x	x
	5	1024 x 768	Mono8		xx*	xx*	xx*	xx*	xx*
	6	800 x 600	Mono16		x	x	x	x	
	7	1024 x 768	Mono16		x	x	x	x	x
2	0	1280 x 960	YUV422			x	x	x	x
	1	1280 x 960	RGB8			x	x	x	x
	2	1280 x 960	Mono-chrome 8		xx*	xx*	xx*	xx*	xx*
	3	1600 x 1200	YUV422						
	4	1600 x 1200	RGB8						
	5	1600 x 1200	Mono8						
	6	1280 x 960	Mono16			x	x	x	x
	7	1600 x 1200	Mono16						

Table 83: Video fixed formats Stingray F-125B/F-125C

*: Color camera outputs Mono8 interpolated image.

 Frame rates with shading are only achievable with IEEE 1394b (S800).

Note



The following table shows default Format_7 modes without Format_7 mode mapping.

- see chapter [Mapping of possible Format_7 modes to F7M1 to F7M7](#) on page 164
- see chapter [Format_7 mode mapping](#) on page 322

Format	Mode	Resolution	Color mode	Maximal S800 frame rates for Format_7 modes	
7	0	1292 x 964 1292 x 964	Mono8 Mono12 Mono16 YUV411 YUV422,Raw16 Mono8,Raw8 RGB8 Raw12	30 fps 30 fps 26 fps 30 fps 26 fps 30 fps 17 fps 30 fps	
	1	644 x 964	Mono8 Mono12 Mono16	30 fps 30 fps 30 fps	2x H-binning 2x H-binning 2x H-binning
	2	1292 x 482	Mono8 Mono12 Mono16	53 fps 53 fps 52 fps	2x V-binning 2x V-binning 2x V-binning
	3	644 x 482	Mono8 Mono12 Mono16	53 fps 53 fps 53 fps	2x H+V binning 2x H+V binning 2x H+V binning
	4	644 x 964 644 x 964	Mono8 Mono12 Mono16 YUV411 YUV422,Raw16 Mono8,Raw8 RGB8 Raw12	30 fps 30 fps 30 fps 30 fps 30 fps 30 fps 30 fps 30 fps	2 out of 4 H-sub-sampling 2 out of 4 H-sub-sampling 2 out of 4 H-sub-sampling 2 out of 4 H-sub-sampling 2 out of 4 H-sub-sampling 2 out of 4 H-sub-sampling 2 out of 4 H-sub-sampling 2 out of 4 H-sub-sampling
	5#	1292 x 482 1292 x 482	Mono8 Mono12 Mono16 YUV411 YUV422,Raw16 Mono8,Raw8 RGB8 Raw12	30 fps 30 fps 30 fps 30 fps 30 fps 30 fps 30 fps 30 fps	2 out of 4 V-sub-sampling 2 out of 4 V-sub-sampling 2 out of 4 V-sub-sampling 2 out of 4 V-sub-sampling 2 out of 4 V-sub-sampling 2 out of 4 V-sub-sampling 2 out of 4 V-sub-sampling 2 out of 4 V-sub-sampling
	6#	644 x 964 644 x 482	Mono8 Mono12 Mono16 YUV411 YUV422,Raw16 Mono8,Raw8 RGB8 Raw12	30 fps 30 fps 30 fps 30 fps 30 fps 30 fps 30 fps 30 fps	2 out of 4 H+V-sub-sampling 2 out of 4 H+V-sub-sampling 2 out of 4 H+V-sub-sampling 2 out of 4 H+V-sub-sampling 2 out of 4 H+V-sub-sampling 2 out of 4 H+V-sub-sampling 2 out of 4 H+V-sub-sampling 2 out of 4 H+V-sub-sampling

Table 84: Video Format_7 default modes Stingray F-125B/F-125C

#: Vertical sub-sampling is done via digitally concealing certain lines, so the frame rate is not
 frame rate = f (AOI height)
 but
 frame rate = f (2 x AOI height)

Stingray F-145B/F-145C (including board level variants)

Format	Mode	Resolution	Color mode	60 fps	30 fps	15 fps	7.5 fps	3.75 fps	1.875 fps
0	0	160 x 120	YUV444						
	1	320 x 240	YUV422		x	x	x	x	x
	2	640 x 480	YUV411			x	x	x	x
	3	640 x 480	YUV422			x	x	x	x
	4	640 x 480	RGB8			x	x	x	x
	5	640 x 480	Mono8			xx*	xx*	xx*	xx*
	6	640 x 480	Mono16			x	x	x	x
1	0	800 x 600	YUV422			x	x	x	
	1	800 x 600	RGB8			x	x		
	2	800 x 600	Mono8			xx*	xx*		
	3	1024 x 768	YUV422			x	x	x	x
	4	1024 x 768	RGB8			x	x	x	x
	5	1024 x 768	Mono8			xx*	xx*	xx*	xx*
	6	800 x 600	Mono16			x	x	x	
	7	1024 x 768	Mono16			x	x	x	x
2	0	1280 x 960	YUV422			x	x	x	x
	1	1280 x 960	RGB8			x	x	x	x
	2	1280 x 960	Mono-chrome 8			xx*	xx*	xx*	xx*
	3	1600 x 1200	YUV422						
	4	1600 x 1200	RGB8						
	5	1600 x 1200	Mono8						
	6	1280 x 960	Mono16			x	x	x	x
	7	1600 x 1200	Mono16						

Table 85: Video fixed formats Stingray F-145B/F-145C

*: Color camera outputs Mono8 interpolated image.

 Frame rates with shading are only achievable with IEEE 1394b (S800).

Note



The following table shows default Format_7 modes without Format_7 mode mapping.

- see chapter [Mapping of possible Format_7 modes to F7M1 to F7M7](#) on page 164
- see chapter [Format_7 mode mapping](#) on page 322

Format	Mode	Resolution	Color mode	Maximal S800 frame rates for Format_7 modes	
7	0	1388 x 1038 1388 x 1038	Mono8 Mono12 Mono16 YUV411 YUV422,Raw16 Mono8,Raw8 RGB8 Raw12	16 fps 16 fps 16 fps 16 fps 16 fps 16 fps 15 fps 16 fps	
	1	692 x 1038	Mono8 Mono12 Mono16	16 fps 16 fps 16 fps	2x H-binning 2x H-binning 2x H-binning
	2	1388 x 518	Mono8 Mono12 Mono16	27 fps 27 fps 27 fps	2x V-binning 2x V-binning 2x V-binning
	3	692 x 518	Mono8 Mono12 Mono16	27 fps 27 fps 27 fps	2x H+V binning 2x H+V binning 2x H+V binning
	4	692 x 1038 692 x 1038	Mono8 Mono12 Mono16 YUV411 YUV422,Raw16 Mono8,Raw8 RGB8 Raw12	16 fps 16 fps 16 fps 16 fps 16 fps 16 fps 16 fps 16 fps	2 out of 4 H-sub-sampling 2 out of 4 H-sub-sampling 2 out of 4 H-sub-sampling 2 out of 4 H-sub-sampling 2 out of 4 H-sub-sampling 2 out of 4 H-sub-sampling 2 out of 4 H-sub-sampling 2 out of 4 H-sub-sampling
	5#	1388 x 518 1388 x 518	Mono8 Mono12 Mono16 YUV411 YUV422,Raw16 Mono8,Raw8 RGB8 Raw12	16 fps 16 fps 16 fps 16 fps 16 fps 16 fps 16 fps 16 fps	2 out of 4 V-sub-sampling 2 out of 4 V-sub-sampling 2 out of 4 V-sub-sampling 2 out of 4 V-sub-sampling 2 out of 4 V-sub-sampling 2 out of 4 V-sub-sampling 2 out of 4 V-sub-sampling 2 out of 4 V-sub-sampling
	6#	692 x 518 692 x 518	Mono8 Mono12 Mono16 YUV411 YUV422,Raw16 Mono8,Raw8 RGB8 Raw12	16 fps 16 fps 16 fps 16 fps 16 fps 16 fps 16 fps 16 fps	2 out of 4 H+V-sub-sampling 2 out of 4 H+V-sub-sampling 2 out of 4 H+V-sub-sampling 2 out of 4 H+V-sub-sampling 2 out of 4 H+V-sub-sampling 2 out of 4 H+V-sub-sampling 2 out of 4 H+V-sub-sampling 2 out of 4 H+V sub-sampling

Table 86: Video Format_7 default modes Stingray F-145B/F-145C

#: Vertical sub-sampling is done via digitally concealing certain lines, so the frame rate is not
frame rate = f (AOI height)
but
frame rate = f (2 x AOI height)

Stingray F-146B/F-146C (including board level variants)

Format	Mode	Resolution	Color mode	60 fps	30 fps	15 fps	7.5 fps	3.75 fps	1.875 fps
0	0	160 x 120	YUV444						
	1	320 x 240	YUV422		x	x	x	x	x
	2	640 x 480	YUV411			x	x	x	x
	3	640 x 480	YUV422			x	x	x	x
	4	640 x 480	RGB8						
	5	640 x 480	Mono8			xx*	xx*	xx*	xx*
	6	640 x 480	Mono16			x	x	x	x
1	0	800 x 600	YUV422			x	x	x	
	1	800 x 600	RGB8						
	2	800 x 600	Mono8			xx*	xx*		
	3	1024 x 768	YUV422			x	x	x	x
	4	1024 x 768	RGB8						
	5	1024 x 768	Mono8			xx*	xx*	xx*	xx*
	6	800 x 600	Mono16			x	x	x	
	7	1024 x 768	Mono16			x	x	x	x
2	0	1280 x 960	YUV422			x	x	x	x
	1	1280 x 960	RGB8						
	2	1280 x 960	Mono-chrome 8			xx*	xx*	xx*	xx*
	3	1600 x 1200	YUV422						
	4	1600 x 1200	RGB8						
	5	1600 x 1200	Mono8						
	6	1280 x 960	Mono16			x	x	x	x
	7	1600 x 1200	Mono16						

Table 87: Video fixed formats Stingray F-146B/F-146C

*: Color camera outputs Mono8 interpolated image.

 Frame rates with shading are only achievable with IEEE 1394b (S800).

Note



The following table shows default Format_7 modes without Format_7 mode mapping.

- see chapter [Mapping of possible Format_7 modes to F7M1 to F7M7](#) on page 164
- see chapter [Format_7 mode mapping](#) on page 322

Format	Mode	Resolution	Color mode	Maximal S800 frame rates for Format_7 modes	
7	0	1388 x 1038 1388 x 1038	Mono8 Mono12 Mono16 YUV411 YUV422,Raw16 Mono8,Raw8 RGB8 Raw12	15 fps 15 fps 15 fps 15 fps 15 fps 15 fps 15 fps 15 fps	
	1	692 x 1038	Mono8 Mono12 Mono16	15 fps 15 fps 15 fps	2x H-binning 2x H-binning 2x H-binning
	2	1388 x 518	Mono8 Mono12 Mono16	26 fps 26 fps 26 fps	2x V-binning 2x V-binning 2x V-binning
	3	692 x 518	Mono8 Mono12 Mono16	26 fps 26 fps 26 fps	2x H+V binning 2x H+V binning 2x H+V binning
	4	692 x 1038 692 x 1038	Mono8 Mono12 Mono16 YUV411 YUV422,Raw16 Mono8,Raw8 RGB8 Raw12	15 fps 15 fps 15 fps 15 fps 15 fps 15 fps 15 fps 15 fps	2 out of 4 H-sub-sampling 2 out of 4 H-sub-sampling 2 out of 4 H-sub-sampling 2 out of 4 H-sub-sampling 2 out of 4 H-sub-sampling 2 out of 4 H-sub-sampling 2 out of 4 H-sub-sampling 2 out of 4 H-sub-sampling
	5#	1388 x 518 1388 x 518	Mono8 Mono12 Mono16 YUV411 YUV422,Raw16 Mono8,Raw8 RGB8 Raw12	15 fps 15 fps 15 fps 15 fps 15 fps 15 fps 15 fps 15 fps	2 out of 4 V-sub-sampling 2 out of 4 V-sub-sampling 2 out of 4 V-sub-sampling 2 out of 4 V-sub-sampling 2 out of 4 V-sub-sampling 2 out of 4 V-sub-sampling 2 out of 4 V-sub-sampling 2 out of 4 V-sub-sampling
	6#	692 x 518 692 x 518	Mono8 Mono12 Mono16 YUV411 YUV422,Raw16 Mono8,Raw8 RGB8 Raw12	15 fps 15 fps 15 fps 15 fps 15 fps 15 fps 15 fps 15 fps	2 out of 4 H+V-sub-sampling 2 out of 4 H+V-sub-sampling 2 out of 4 H+V-sub-sampling 2 out of 4 H+V-sub-sampling 2 out of 4 H+V-sub-sampling 2 out of 4 H+V-sub-sampling 2 out of 4 H+V-sub-sampling 2 out of 4 H+V sub-sampling

Table 88: Video Format_7 default modes Stingray F-146B/F-146C

#: Vertical sub-sampling is done via digitally concealing certain lines, so the frame rate is not
frame rate = f (AOI height)
but
frame rate = f (2 x AOI height)

Stingray F-201B/F-201C (including board level variants)

Format	Mode	Resolution	Color mode	60 fps	30 fps	15 fps	7.5 fps	3.75 fps	1.875 fps
0	0	160 x 120	YUV444						
	1	320 x 240	YUV422		x	x	x	x	x
	2	640 x 480	YUV411		x	x	x	x	x
	3	640 x 480	YUV422		x	x	x	x	x
	4	640 x 480	RGB8						
	5	640 x 480	Mono-chrome 8		xx*	xx*	xx*	xx*	xx*
	6	640 x 480	Mono-chrome 16		x	x	x	x	x
1	0	800 x 600	YUV422			x	x	x	
	1	800 x 600	RGB8						
	2	800 x 600	Mono8			xx*	xx*		
	3	1024 x 768	YUV422			x	x	x	x
	4	1024 x 768	RGB8						
	5	1024 x 768	Mono-chrome 8			xx*	xx*	xx*	xx*
	6	800 x 600	Mono16			x	x	x	
	7	1024 x 768	Mono16			x	x	x	x
2	0	1280 x 960	YUV422				x	x	x
	1	1280 x 960	RGB8						
	2	1280 x 960	Mono-chrome 8			xx*	xx*	xx*	xx*
	3	1600 x 1200	YUV422				x	x	x
	4	1600 x 1200	RGB8						
	5	1600 x 1200	Mono8			xx*	xx*	xx*	xx*
	6	1280 x 960	Mono16			x	x	x	x
	7	1600 x 1200	Mono16			x	x	x	x

Table 89: Video fixed formats Stingray F-201B/F-201C

*: Color camera outputs Mono8 interpolated image.

 Frame rates with shading are only achievable with IEEE 1394b (S800).

Note



The following table shows default Format_7 modes without Format_7 mode mapping.

- see chapter [Mapping of possible Format_7 modes to F7M1 to F7M7](#) on page 164
- see chapter [Format_7 mode mapping](#) on page 322

Format	Mode	Resolution	Color mode	Maximal S800 frame rates for Format_7 modes	
7	0	1624 x 1234 1624 x 1234	Mono8 Mono12 Mono16 YUV411 YUV422,Raw16 Mono8,Raw8 RGB8 Raw12	14 fps 14 fps 14 fps 14 fps 14 fps 14 fps 10 fps 14 fps	
	1	812 x 1234 812 x 1234	Mono8 Mono12 Mono16 YUV411 YUV422,Raw16 Mono8,Raw8 RGB8 Raw12	14 fps 14 fps 14 fps 14 fps 14 fps 14 fps 14 fps 14 fps	2x H-binning 2x H-binning 2x H-binning 2x H-binning 2x H-binning 2x H-binning 2x H-binning 2x H-binning
	2	1624 x 616 1624 x 614	Mono8 Mono12 Mono16 YUV411 YUV422,Raw16 Mono8,Raw8 RGB8 Raw12	26 fps 26 fps 26 fps 26 fps 26 fps 26 fps 21 fps 26 fps	2x V-binning 2x V-binning 2x V-binning 2x V-binning 2x V-binning 2x V-binning 2x V-binning 2x V-binning
	3	812 x 616 812 x 614	Mono8 Mono12 Mono16 YUV411 YUV422,Raw16 Mono8,Raw8 RGB8 Raw12	26 fps 26 fps 26 fps 26 fps 26 fps 26 fps 26 fps 26 fps	2x H+V binning 2x H+V binning 2x H+V binning 2x H+V binning 2x H+V binning 2x H+V binning 2x H+V binning 2x H+V binning
	4	812 x 1234 812 x 1234	Mono8 Mono12 Mono16 YUV411 YUV422,Raw16 Mono8,Raw8 RGB8 Raw12	14 fps 14 fps 14 fps 14 fps 14 fps 14 fps 14 fps 14 fps	2 out of 4 H-sub-sampling 2 out of 4 H-sub-sampling 2 out of 4 H-sub-sampling 2 out of 4 H-sub-sampling 2 out of 4 H-sub-sampling 2 out of 4 H-sub-sampling 2 out of 4 H-sub-sampling 2 out of 4 H-sub-sampling

Table 90: Video Format_7 default modes Stingray F-201B/F-201C

Format	Mode	Resolution	Color mode	Maximal S800 frame rates for Format_7 modes	
7	5#	1624 x 616	Mono8	14 fps	2 out of 4 V-sub-sampling
			Mono12	14 fps	2 out of 4 V-sub-sampling
			Mono16	14 fps	2 out of 4 V-sub-sampling
		1624 x 616	YUV411	14 fps	2 out of 4 V-sub-sampling
			YUV422,Raw16	14 fps	2 out of 4 V-sub-sampling
			Mono8,Raw8	14 fps	2 out of 4 V-sub-sampling
			RGB8	14 fps	2 out of 4 V-sub-sampling
		Raw12	14 fps	2 out of 4 V-sub-sampling	
	6#	812 x 616	Mono8	14 fps	2 out of 4 H+V sub-sampling
			Mono12	14 fps	2 out of 4 H+V sub-sampling
			Mono16	14 fps	2 out of 4 H+V sub-sampling
		812 x 616	YUV411	14 fps	2 out of 4 H+V sub-sampling
			YUV422,Raw16	14 fps	2 out of 4 H+V sub-sampling
			Mono8,Raw8	14 fps	2 out of 4 H+V sub-sampling
		RGB8	14 fps	2 out of 4 H+V sub-sampling	
	Raw12	14 fps	2 out of 4 H+V sub-sampling		

Table 90: Video Format_7 default modes Stingray F-201B/F-201C (continued)

#: Vertical sub-sampling is done via digitally concealing certain lines, so the frame rate is not

frame rate = f (AOI height)

but

frame rate = f (2 x AOI height)

Stingray F-504B/F-504C (including board level variants)

Format	Mode	Resolution	Color mode	60 fps	30 fps	15 fps	7.5 fps	3.75 fps	1.875 fps
0	0	160 x 120	YUV444						
	1	320 x 240	YUV422		x	x	x	x	x
	2	640 x 480	YUV411			x	x	x	x
	3	640 x 480	YUV422			x	x	x	x
	4	640 x 480	RGB8			x	x	x	x
	5	640 x 480	Mono8			xx*	xx*	xx*	xx*
	6	640 x 480	Mono16			x	x	x	x
1	0	800 x 600	YUV422			x	x	x	
	1	800 x 600	RGB8			x	x		
	2	800 x 600	Mono8			xx*	xx*		
	3	1024 x 768	YUV422			x	x	x	x
	4	1024 x 768	RGB8			x	x	x	x
	5	1024 x 768	Mono8			xx*	xx*	xx*	xx*
	6	800 x 600	Mono16			x	x	x	
	7	1024 x 768	Mono16			x	x	x	x
2	0	1280 x 960	YUV422			x	x	x	x
	1	1280 x 960	RGB8			x	x	x	x
	2	1280 x 960	Mono8			xx*	xx*	xx*	xx*
	3	1600 x 1200	YUV422				x	x	x
	4	1600 x 1200	RGB8				x	x	x
	5	1600 x 1200	Mono8				xx*	xx*	xx*
	6	1280 x 960	Mono16			x	x	x	x
	7	1600 x 1200	Mono16				x	x	x

Table 91: Video fixed formats Stingray F-504B/F-504C

*: Color camera outputs Mono8 interpolated image.

 Frame rates with shading are only achievable with IEEE 1394b (S800).

Note



The following table shows default Format_7 modes without Format_7 mode mapping.

- see chapter [Mapping of possible Format_7 modes to F7M1 to F7M7](#) on page 164
- see chapter [Format_7 mode mapping](#) on page 322

Format	Mode	Resolution	Color mode	Maximal S800 frame rates for Format_7 modes	
7	0	2452 x 2056 2452 x 2056	Mono8 Mono12 Mono16 YUV411 YUV422,Raw16 Mono8,Raw8 RGB8 Raw12	9 fps 8 fps 6 fps 8 fps 6 fps 9 fps 4 fps 8 fps	
	1	1224 x 2056	Mono8 Mono12 Mono16	9 fps 9 fps 9 fps	2x H-binning 2x H-binning 2x H-binning
	2	2452 x 1028	Mono8 Mono12 Mono16	15 fps 15 fps 12 fps	2x V-binning 2x V-binning 2x V-binning
	3	1224 x 1028	Mono8 Mono12 Mono16	15 fps 15 fps 15 fps	2x H+V binning 2x H+V binning 2x H+V binning
	4	1224 x 2056 1224 x 2056	Mono8 Mono12 Mono16 YUV411 YUV422,Raw16 Mono8,Raw8 RGB8 Raw12	9 fps 9 fps 9 fps 9 fps 9 fps 9 fps 8 fps 9 fps	2 out of 4 H-sub-sampling 2 out of 4 H-sub-sampling 2 out of 4 H-sub-sampling 2 out of 4 H-sub-sampling 2 out of 4 H-sub-sampling 2 out of 4 H-sub-sampling 2 out of 4 H-sub-sampling 2 out of 4 H-sub-sampling
7	5#	2452 x 1028 2452 x 1028	Mono8 Mono12 Mono16 YUV411 YUV422,Raw16 Mono8,Raw8 RGB8 Raw12	9 fps 9 fps 9 fps 9 fps 9 fps 9 fps 8 fps 9 fps	2 out of 4 V-sub-sampling 2 out of 4 V-sub-sampling 2 out of 4 V-sub-sampling 2 out of 4 V-sub-sampling 2 out of 4 V-sub-sampling 2 out of 4 V-sub-sampling 2 out of 4 V-sub-sampling 2 out of 4 V-sub-sampling
	6#	1224 x 1028 1224 x 1028	Mono8 Mono12 Mono16 YUV411 YUV422,Raw16 Mono8,Raw8 RGB8 Raw12	9 fps 9 fps 9 fps 9 fps 9 fps 9 fps 9 fps 9 fps	2 out of 4 H+V sub-sampling 2 out of 4 H+V sub-sampling 2 out of 4 H+V sub-sampling 2 out of 4 H+V sub-sampling 2 out of 4 H+V sub-sampling 2 out of 4 H+V sub-sampling 2 out of 4 H+V sub-sampling 2 out of 4 H+V sub-sampling

Table 92: Video Format_7 default modes Stingray F-504B/F-504C

#: Vertical sub-sampling is done via digitally concealing certain lines, so the frame rate is not
frame rate = f (AOI height)
but
frame rate = f (2 x AOI height).

Area of interest (AOI)

The camera's image sensor has a defined resolution. This indicates the maximum number of lines and pixels per line that the recorded image may have.

However, often only a certain section of the entire image is of interest. The amount of data to be transferred can be decreased by limiting the image to a section when reading it out from the camera. At a lower vertical resolution, the sensor can be read out faster. Thus, the frame rate is increased.

Note _____ The setting of AOIs is supported only in video Format_7.



For most other video formats, the size of the image read out and modes is fixed by the IIDC specification, thereby determining the highest possible frame rate. In Format_7 mode the user can set the **upper left corner**, as well as **width and height** of the section (area of interest = AOI) to determine the size and thus the highest possible frame rate.

Setting the AOI is done in the IMAGE_POSITION and IMAGE_SIZE registers.

Note _____ Pay attention to the increments entering in the UNIT_SIZE_INQ and UNIT_POSITION_INQ registers when configuring IMAGE_POSITION and IMAGE_SIZE.



AF_AREA_POSITION and AF_AREA_SIZE contain in the respective bits values for column and line of the upper left corner and values for the width and height.

Note _____ For more information see [Table 124](#) on page 283.



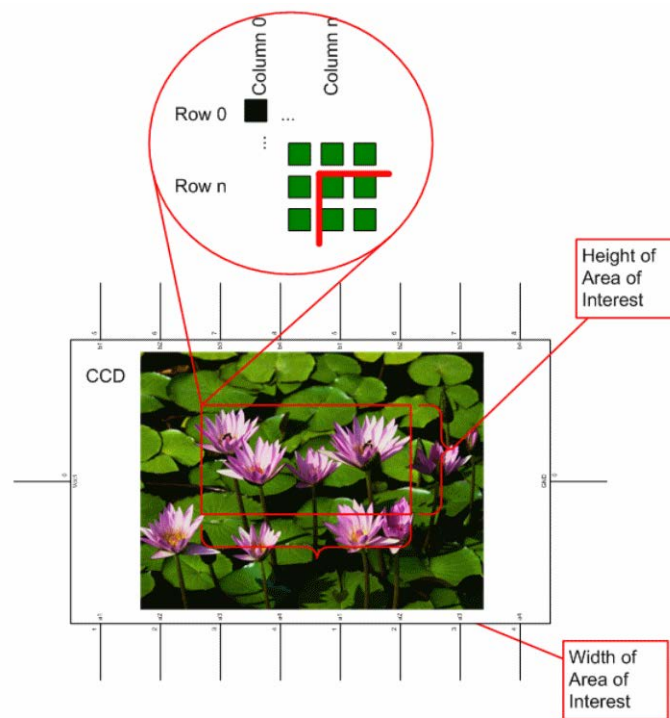

Figure 93: Area of interest

Note



- The left position + width and the upper position + height may not exceed the maximum resolution of the sensor.
- The coordinates for width and height must be divisible by four.

In addition to the area of interest, some other parameters have an effect on the maximum frame rate:

- The time for reading the image from the sensor and transporting it into the FRAME_BUFFER
- The time for transferring the image over the FireWire Ñ bus
- The length of the exposure time

Autofunction AOI

Feature to select the image area (work area) for the following auto functions:

- Auto shutter
- Auto gain
- Auto white balance

The following screenshot shows an example of the auto function AOI:

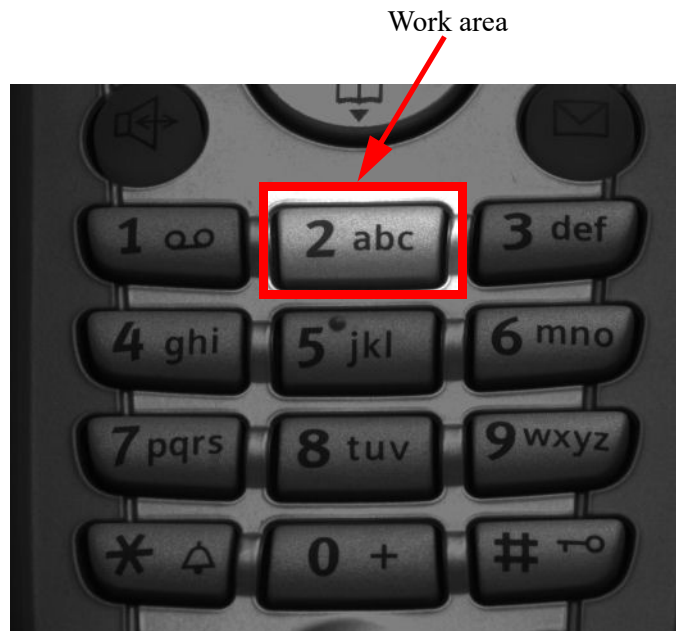

Figure 94: Example of autofunction AOI (*Show work area* is on)

Note



Autofunction AOI is independent from Format_7 AOI settings.

If you switch off auto function AOI, work area position and work area size follow the current active image size.

To switch off auto functions, carry out following actions in the order shown:

1. Uncheck **Show AOI** check box (SmartView **Ctrl2** tab).
2. Uncheck **Enable** check box (SmartView **Ctrl2** tab).
Switch off Auto mode (e.g., **Shutter** and/or **Gain**) (SmartView **Ctrl2** tab).

It uses a grid of up to 65534 sample points equally spread over the AOI as a reference.

Note



Configuration

To configure this feature in an advanced register see chapter [Autofunction AOI](#) on page 312.

Frame rates

The IEEE 1394b bus has bandwidth of at least 62.5 MB/s for transferring (isochronously) image data. Therefore, up to 8192 bytes per cycle (or around 2000 quadlets = 4 bytes@ 800 Mb/s) can be transmitted.

Depending on the video format settings and the configured frame rate, the camera requires a certain percentage of maximum available bandwidth. Clearly, the bigger the image and the higher the frame rate, the more data is to be transmitted.

The following tables indicate the volume of data in various formats and modes to be sent within one cycle (125 μ s) at 800 Mb/s of bandwidth.

The tables are divided into three formats:

Format	Resolution	Maximum video format
Format_0	up to VGA	640 x 480
Format_1	up to XGA	1024 x 768
Format_2	up to UXGA	1600 x 1200

Table 93: Overview fixed formats

The bandwidth is determined by the required image resolution and by the number of cameras that have to be operated independently on a bus in a certain mode.

Abbreviations (used according IIDC IEEE 1394-based Digital Camera Specification):

- H: line/packet
- p: pixel/packet
- q: quadlet/packet

Format	Mode	Resolution	240 fps	120 fps	60 fps	30 fps	15 fps	7.5 fps	3.75 fps
0	0	160 x 120 YUV (4:4:4) 24 bit/pixel	4H 640p 480q	2H 320p 240q	1H 160p 120q	1/2H 80p 60q	1/4H 40p 30q	1/8H 20p 15q	
	1	320 x 240 YUV (4:2:2) 16 bit/pixel	8H 2560p 1280q	4H 1280p 640q	2H 640p 320q	1H 320p 160q	1/2H 160p 80q	1/4H 80p 40q	1/8H 40p 20q
	2	640 x 480 YUV (4:1:1) 12 bit/pixel		8H 5120p 1920q	4H 2560p 960q	2H 1280p 480q	1H 640p 240q	1/2H 320p 120q	1/4H 160p 60q
	3	640 x 480 YUV (4:2:2) 16 bit/pixel			4H 2560p 1280q	2H 1280p 640q	1H 640p 320q	1/2H 320p 160q	1/4H 160p 80q
	4	640 x 480 RGB 24 bit/pixel			4H 2560p 1280q	2H 1280p 960q	1H 640p 480q	1/2H 320p 240q	1/4H 160p 120q
	5	640 x 480 (Mono8) 8 bit/pixel		8H 5120p 1280q	4H 2560p 640q	2H 1280p 320q	1H 640p 160q	1/2H 320p 80q	1/4H 160p p40q
	6	640 x 480 Y (Mono16) 16 Bit/pixel			4H 2560p 1280q	2H 1280p 640q	1H 640p 320q	1/2H 320p 160q	1/4H 160p 80q
	7	Reserved							

Table 94: Format_0

As an example, VGA Mono8 @ 60 fps requires four lines (640 x 4 = 2560 pixels/byte) to transmit every 125 μ s: this is a consequence of the sensor's line time of about 30 μ s: therefore, no data needs to be stored temporarily.

It takes 120 cycles (120 x 125 μ s = 15 ms) to transmit one frame, which arrives every 16.6 ms from the camera. Again, no data need to be stored temporarily.

Thus, around 64% of the available bandwidth (at S400) is used. Consequently, one camera can be connected to the bus at S400.

The same camera, run at S800 would require only 32% of the available bandwidth. Thus, up to three cameras can be connected to the bus at S800.

Format	Mode	Resolution	240 fps	120 fps	60 fps	30 fps	15 fps	7.5 fps	3.75 fps	1.875 fps
1	0	800 x 600 YUV (4:2:2) 16 bit/pixel			5H 4000p 2000q	5/2H 2000p 1000q	5/4H 1000p 500q	5/8H 500p 250q	6/16H 250p 125q	
	1	800 x 600 RGB 24 bit/pixel				5/2H 2000p 1500q	5/4H 1000p 750q	5/8H 500p 375q		
	2	800 x 600 Y (Mono8) 8 bit/pixel		10H 8000p 2000q	5H 4000p 1000q	5/2H 2000p 500q	5/4H 1000p 250q	5/8H 500p 125q		
	3	1024 x 768 YUV (4:2:2) 16 bit/pixel				3H 3072p 1536q	3/2H 1536p 768q	3/4H 768p 384q	3/8H 384p 192q	3/16H 192p 96q
	4	1024 x 768 RGB 24 bit/pixel					3/2H 1536p 384q	3/4H 768p 576q	3/8H 384p 288q	3/16H 192p 144q
	5	1024 x 768 Y (Mono- chrome) 8 bit/pixel			6H 6144p 1536q	3H 3072p 768q	3/2H 1536p 384q	3/4H 768p 192q	3/8H 384p 96q	3/16H 192p 48q
	6	800 x 600 (Mono16) 16 bit/pixel			5H 4000p 2000q	5/2H 2000p 1000q	5/4H 1000p 500q	5/8H 500p 250q	5/16H 250p 125q	
	7	1024 x 768 Y (Mono16) 16 bit/pixel				3H 3072p 1536q	3/2H 1536p 768q	3/4H 768p 384q	3/8H 384p 192q	3/16H 192p 96q

Table 95: Format_1

Format	Mode	Resolution	60 fps	30 fps	15 fps	7.5 fps	3.75 fps	1.875 fps	
2	0	1280 x 960 YUV (4:2:2) 16 bit/pixel				2H 2560p 1280q	1H 1280p 640q	1/2H 640p 320q	1/4H 320p 160q
	1	1280 x 960 RGB 24 bit/pixel				2H 2560p 1920q	1H 1280p 960q	1/2H 640p 480q	1/4H 320p 240q
	2	1280 x 960 Y (Mono8) 8 bit/pixel		4H 5120p 1280q		2H 2560p 640q	1H 1280p 320q	1/2H 640p 160q	1/4H 320p 80q
	3	1600 x 1200 YUV(4:2:2) 16 bit/pixel				5/2H 4000p 2000q	5/4H 2000p 1000q	5/8H 1000p 500q	5/16H 500p 250q
	4	1600 x 1200 RGB 24 bit/pixel					5/4H 2000p 1500q	5/8H 1000p 750q	5/16H 500p 375q
	5	1600 x 1200 Y (Mono- chrome) 8 bit/pixel		5H 8000p 2000q		5/2H 4000p 1000q	5/4H 2000p 500q	5/8H 1000p 250q	5/16H 500p 125q
	6	1280 x 960 Y (Mono16) 16 bit/pixel				2H 2560p 1280q	1H 1280p 640q	1/2H 640p 320q	1/4H 320p 160q
	7	1600 x 1200Y(Mono16) 16 bit/pixel				5/2H 4000p 2000q	5/4H 2000p 1000q	5/8H 1000p 500q	5/16H 500p 250q

Table 96: Format_2

As already mentioned, the recommended limit for transferring isochronous image data is 2000q (quadlets) per cycle or 8192 bytes (with 800 Mb/s of bandwidth).

Note



- If the cameras are operated with an external trigger the maximum trigger frequency may not exceed the highest continuous frame rate, thus, preventing frames from being dropped or corrupted.
- IEEE 1394 adapter cards with PCILynx™ chipsets (predecessor of OHCI) have a limit of 4000 bytes per cycle.

The frame rates in video modes 0 to 2 are specified and set fixed by IIDC V1.31.

Frame rates Format_7

In video Format_7 frame rates are no longer fixed.

Note



- Different values apply for the different sensors.
- Frame rates may be further limited by longer shutter times and/or bandwidth limitation from the IEEE 1394 bus.

Details are described in the next chapters:

- Maximum frame rate of CCD (theoretical formula)
- Graphs of frame rates as function of AOI by constant width: the curves describe RAW8, RAW12/YUV411, RAW16/YUV422, RGB8 and maximum frame rate of CCD
- Table with maximum frame rates as function of AOI by constant width

Stingray F-033B/F-033C (incl. board level): AOI frame rates

$$\text{Maximum frame rate of CCD} = \frac{1}{138 \mu\text{s} + \text{AOI height} \times 23.62 \mu\text{s} + (509 - \text{AOI height}) \times 2.64 \mu\text{s}}$$

Formula 7: Stingray F-033: theoretical maximum frame rate of CCD

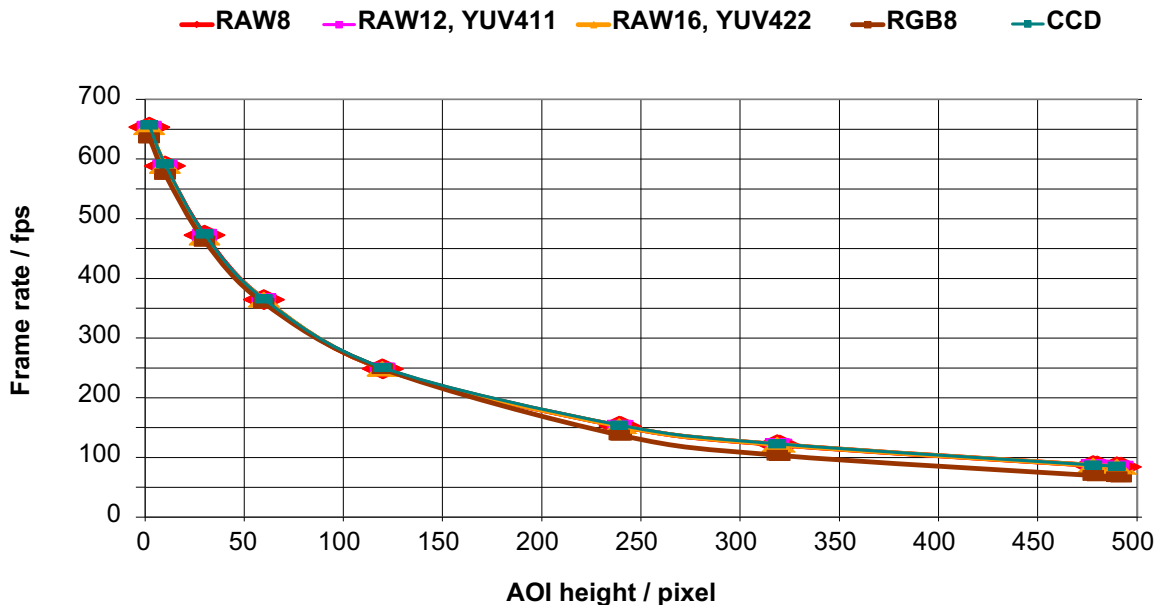

Figure 95: Stingray F-033 frame rate as a function of AOI height [width=656]

AOI height	CCD*	Raw8	Raw12	Raw16	YUV411	YUV422	RGB8
492	84.72	84	84	84	84	84	67/84**
480	86.56	86	86	86	86	86	68/86**
320	122.02	121	121	121	121	121	103/121**
240	153.45	153	153	153	152	152	137/152**
120	250.04	249	249	249	242	247	246
60	364.89	363	363	363	358	358	358
30	473.67	468	468	471	462	462	462
10	591.17	588	588	588	574	574	574
2	656.29	653	653	653	635	635	635

* CCD = theoretical maximum frame rate (in fps) of CCD according to given formula
 **only with max BPP=1100; see chapter [Maximum ISO packet size](#) on page 317

Table 97: Stingray F-033 frame rate as a function of AOI height [width=656]

Stingray F-046B/F-046C (incl. board level): AOI frame rates

$$\text{Maximum frame rate of CCD} = \frac{1}{136.22\mu\text{s} + \text{AOI height} \times 27.59\mu\text{s} + (597 - \text{AOI height}) \times 2.64\mu\text{s}}$$

Formula 8: Stingray F-046: theoretical maximum frame rate of CCD

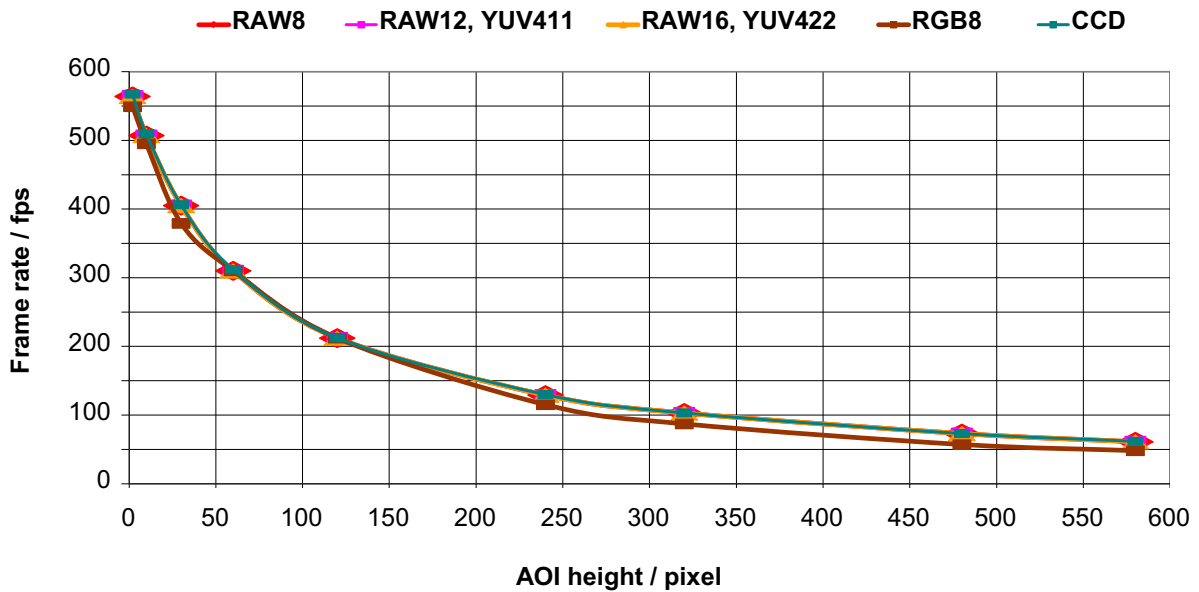

Figure 96: Stingray F-046 frame rate as a function of AOI height [width=780]

AOI height	CCD*	RAW8	RAW12	RAW16	YUV411	YUV422	RGB8
580	61.79	61	61	61	61	61	48
480	73.06	73	73	73	73	73	57
320	103.13	103	103	103	103	103	87
240	129.87	129	129	129	129	129	115
120	212.48	212	212	212	210	210	210
60	311.59	310	310	310	306	306	306
30	406.37	405	405	405	379	379	379
10	509.74	507	507	507	495	495	495
2	567.47	564	564	564	549	549	549

* CCD = theoretical maximum frame rate (in fps) of CCD according to given formula

Table 98: Stingray F-046 frame rate as a function of AOI height [width=780]

Stingray F-080B/F-080C (incl. board level): AOI frame rates

$$\text{Maximum frame rate of CCD} = \frac{1}{222\mu\text{s} + \text{AOI height} \times 40.50\mu\text{s} + (778 - \text{AOI height}) \times 7.00\mu\text{s}}$$

Formula 9: Stingray F-080: theoretical maximum frame rate of CCD

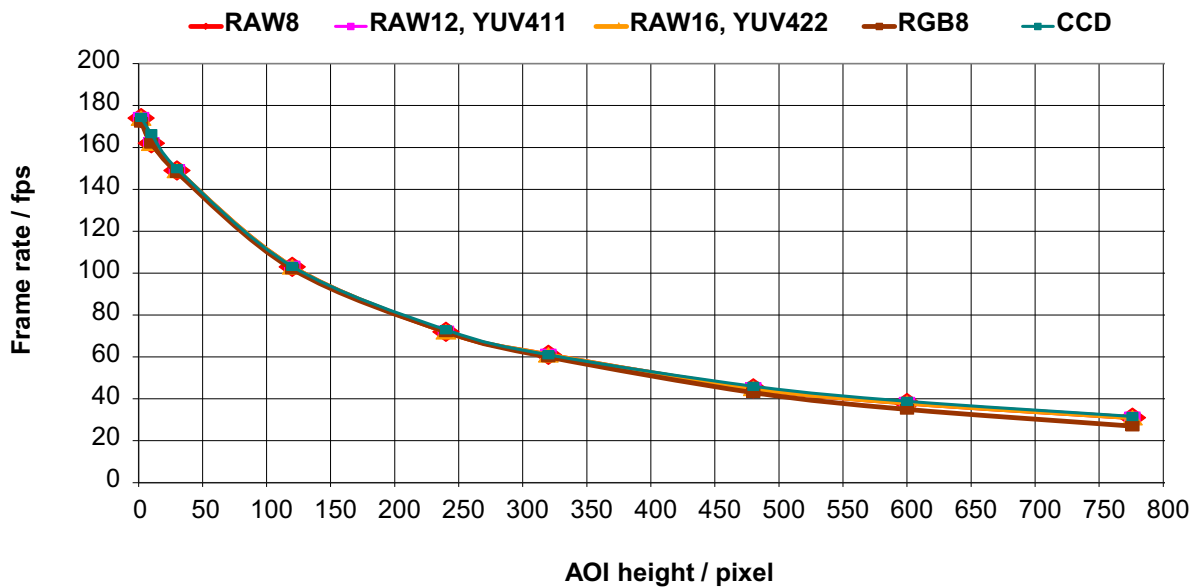

Figure 97: Stingray F-080 frame rate as a function of AOI height [width=1032]

AOI height	CCD*	RAW8	RAW12	RAW16	YUV411	YUV422	RGB8
776	31.56	31	31	31	31	31	27
600	38.81	38	38	38	38	38	35
480	45.98	45	45	45	45	45	43
320	61.02	61	61	61	60	60	60
240	72.95	72	72	72	72	72	72
120	103.22	103	103	103	102	102	102
30	149.86	149	149	149	148	148	148
10	166.58	162	162	162	162	162	162
2	174.37	174	174	174	172	172	172

* CCD = theoretical maximum frame rate (in fps) of CCD according to given formula

Table 99: Stingray F-080 frame rate as a function of AOI height [width=1032]

Stingray F-125B/F-125C (incl. board level): AOI frame rates

$$\text{Max. frame rate of CCD} = \frac{1}{189.28\mu\text{s} + (977 - \text{AOI height}) \times 5.03\mu\text{s} + \text{AOI height} \times 33.19\mu\text{s}}$$

Formula 10: Stingray F-125: theoretical maximum frame rate of CCD

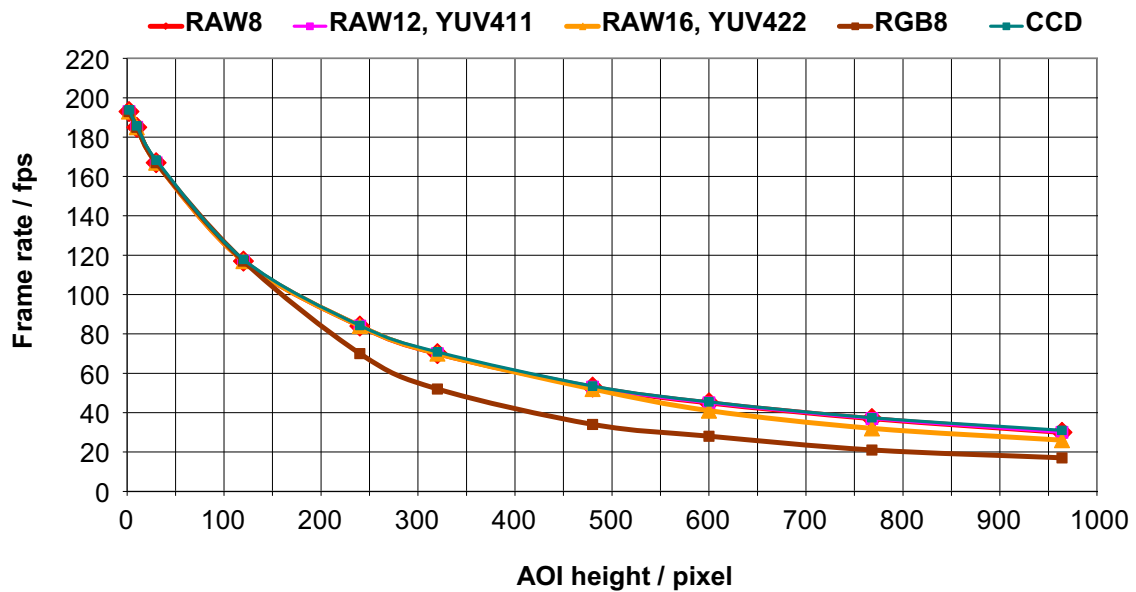

Figure 98: Stingray F-125 frame rate as a function of AOI height [width=1292]

AOI height	CCD*	RAW8	RAW12	RAW16	YUV411	YUV422	RGB8
964	31.01	30	30	26	30	26	17
768	37.41	37	37	32	37	32	21
600	45.46	45	45	41	45	41	28
480	53.70	53	53	52	53	52	34
320	70.85	70	70	70	70	70	52
240	84.30	84	84	84	84	84	70
120	117.89	117	117	117	117	117	117
30	168.37	167	167	167	167	167	167
10	185.69	185	185	185	185	185	185
2	193.80	193	193	193	193	193	193

* CCD = theoretical maximum frame rate (in fps) of CCD according to given formula

Table 100: Stingray F-125 frame rate as a function of AOI height [width=1292]

Stingray F-145B/F-145C (incl. board level): AOI frame rates

$$\text{Max. frame rate of CCD} = \frac{1}{450.00\mu\text{s} + \text{AOI height} \times 59.36\mu\text{s} + (1051 - \text{AOI height}) \times 10.92\mu\text{s}}$$

Formula 11: Stingray F-145: theoretical maximum frame rate of CCD

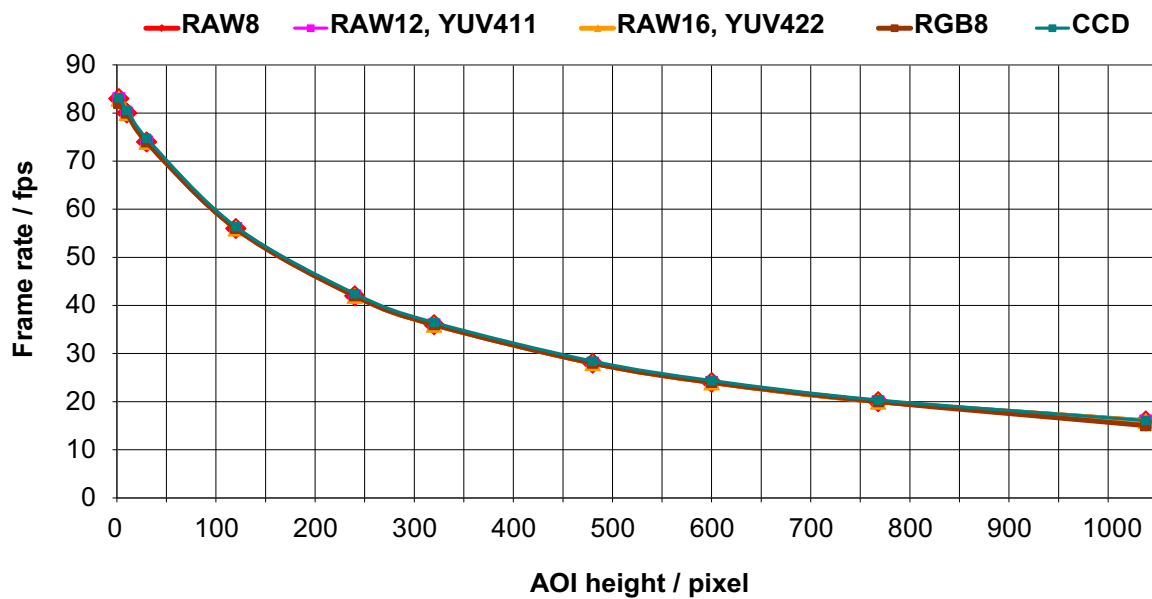

Figure 99: Stingray F-145 frame rate as a function of AOI height [width=1388]

AOI height	CCD*	RAW8	RAW12	RAW16	YUV411	YUV422	RGB8
1038	16.08	16	16	16	16	16	15
768	20.35	20	20	20	20	20	20
600	24.40	24	24	24	24	24	24
480	28.43	28	28	28	28	28	28
320	36.46	36	36	36	36	36	36
240	42.46	42	42	42	42	42	42
120	56.37	56	56	56	56	56	56
30	74.74	74	74	74	74	74	74
10	80.57	80	80	80	80	80	80
2	83.17	83	83	83	82	82	82

* CCD = theoretical maximum frame rate (in fps) of CCD according to given formula

Table 101: Stingray F-145 frame rate as a function of AOI height [width=1388]

Stingray F-146B/F-146C (incl. board level): AOI frame rates

$$\text{Max. frame rate of CCD} = \frac{1}{301.60\mu\text{s} + \text{AOI height} \times 53.55\mu\text{s} + (1051 - \text{AOI height}) \times 10.46\mu\text{s}}$$

Formula 12: Stingray F-146: theoretical maximum frame rate of CCD

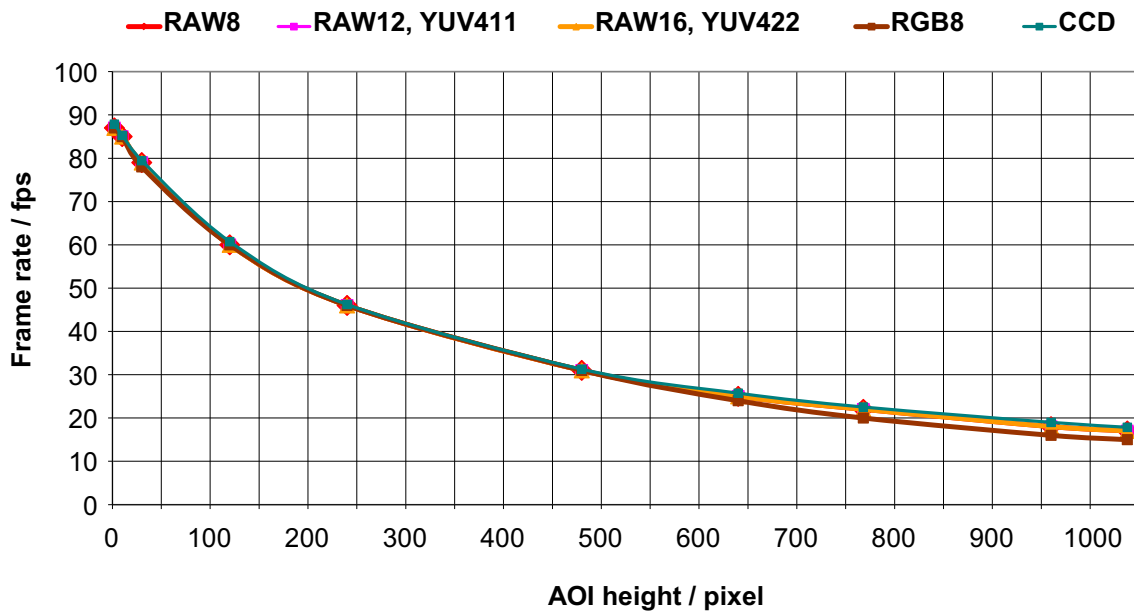

Figure 100: Stingray F-146 frame rate as a function of AOI height [width=1388]

AOI height	CCD*	RAW8	RAW12	RAW16	YUV411	YUV422	RGB8
1038	17.85	17	17	17	17	17	15
960	18.99	18	18	18	18	18	16
768	22.53	22	22	22	22	22	20
640	25.73	25	25	25	25	25	24
480	31.27	31	31	31	31	31	31
240	46.22	46	46	46	46	46	46
120	60.73	60	60	60	60	60	60
30	79.44	79	79	79	78	78	78
10	85.28	85	85	85	85	85	85
2	87.86	87	87	87	87	87	87

* CCD = theoretical maximum frame rate (in fps) of CCD according to given formula

Table 102: Stingray F-146 frame rate as a function of AOI height [width=1388]

Stingray F-201B/F-201C (incl. board level): AOI frame rates

$$\text{Max. frame rate of CCD} = \frac{1}{344.90\mu\text{s} + \text{AOI height} \times 54.81\mu\text{s} + (1238 - \text{AOI height}) \times 7.14\mu\text{s}}$$

Formula 13: Stingray F-201: theoretical maximum frame rate of CCD

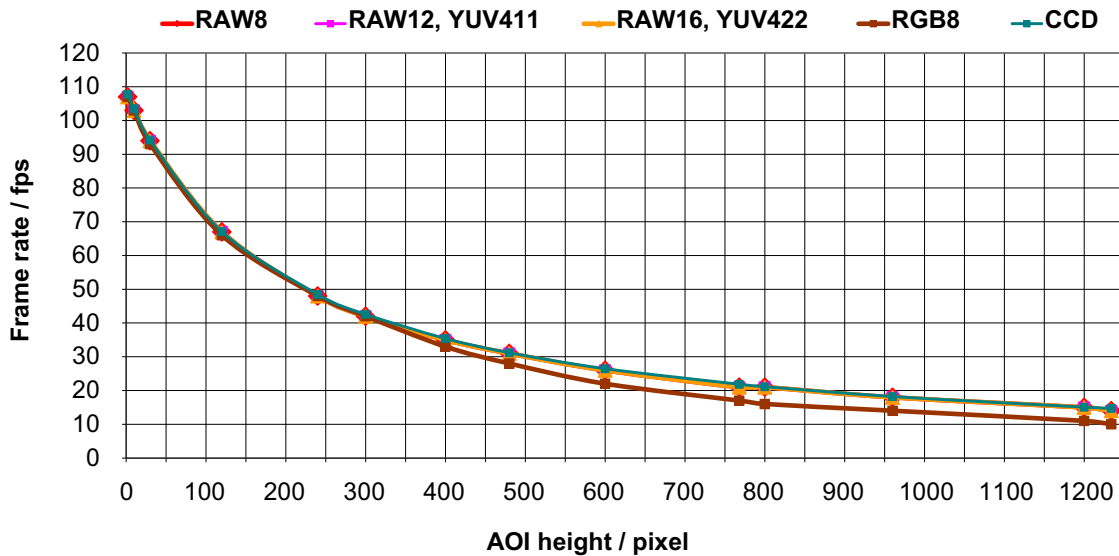

Formula 14: Stingray F-201 frame rate as a function of AOI height [width=1624]

AOI height	CCD*	RAW8	RAW12	RAW16	YUV411	YUV422	RGB8
1234	14.70	14	14	14	14	14	10
1200	15.06	15	15	15	15	15	11
960	18.20	18	18	18	18	18	14
800	21.13	21	21	21	21	21	16
768	21.84	21	21	21	21	21	17
600	26.46	26	26	26	26	26	22
480	31.19	31	31	31	31	31	28
400	35.40	35	35	35	35	35	33
300	42.58	42	42	42	42	42	42
240	48.48	48	48	48	48	48	48
120	67.09	67	67	67	67	67	66
30	94.21	94	94	94	94	94	93
10	103.51	103	103	103	103	103	103
2	107.76	107	107	107	107	107	107

* CCD = theoretical maximum frame rate (in fps) of CCD according to given formula

Table 103: Stingray F-201 frame rate as a function of AOI height [width=1624]

Stingray F-504B/F-504C (incl. board level): AOI frame rates

$$\text{Max. frame rate of CCD} = \frac{1}{292.80\mu\text{s} + (2069 - \text{AOI height}) \times 10.25\mu\text{s} + \text{AOI height} \times 52.53\mu\text{s}}$$

Formula 15: Stingray F-504: theoretical maximum frame rate of CCD

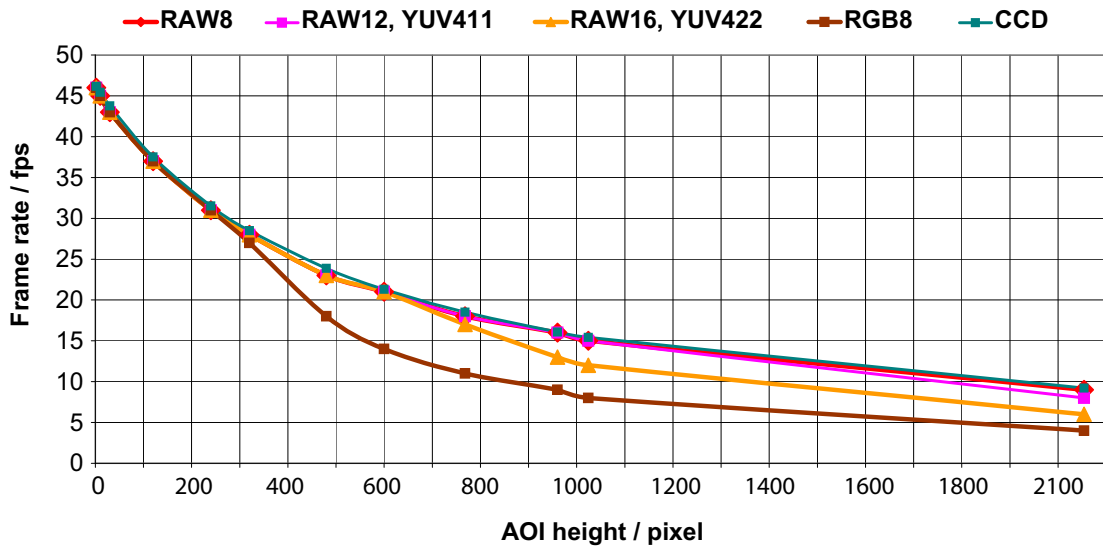

Formula 16: Stingray F-504 frame rate as a function of AOI height [width=2452]

AOI height	CCD*	RAW8	RAW12	RAW16	YUV411	YUV422	RGB8
2054	9.22	9	8	6	8	6	4
1024	15.41	15	15	12	15	12	8
960	16.08	16	16	13	16	13	9
768	18.50	18	18	17	18	17	11
600	21.30	21	21	21	21	21	14
480	23.88	23	23	23	23	23	18
320	28.48	28	28	28	28	28	27
240	31.51	31	31	31	31	31	31
120	37.51	37	37	37	37	37	37
30	43.76	43	43	43	43	43	43
10	45.44	45	45	45	45	45	45
2	46.15	46	46	46	46	46	46

* CCD = theoretical maximum frame rate (in fps) of CCD according to given formula

Table 104: Stingray F-504 frame rate as a function of AOI height [width=2452]

How does bandwidth affect the frame rate?

In some modes, the IEEE 1394b bus limits the attainable frame rate. According to the IEEE 1394b specification on isochronous transfer, the largest data payload size of 8192 bytes per 125 μ s cycle is possible with bandwidth of 800 Mb/s. In addition, there is a limitation: only a maximum number of 65535 ($2^{16} - 1$) packets per frame are allowed.

Note Using **FirePackage**, certain cameras may offer higher packet sizes, depending on their settings.



Should you need detailed support to use this feature, please contact support at www.alliedvision.com/en/about-us/contact-us/technical-support-repair/-rma.

The following formula establishes the relationship between the required Byte_Per_Packet size and certain variables for the image. It is valid only for Format_7.

$$\text{BYTE_PER_PACKET} = \text{frame rate} \times \text{AOI_WIDTH} \times \text{AOI_HEIGHT} \times \text{ByteDepth} \times 125\mu\text{s}$$

Formula 17: Byte_per_Packet calculation (only Format_7)

If the value for **BYTE_PER_PACKET** is greater than 8192 (the maximum data payload), the desired frame rate cannot be attained.

The attainable frame rate can be calculated using this formula:

(Provision: **BYTE_PER_PACKET** is divisible by 4):

$$\text{frame rate} \approx \frac{\text{BYTE_PER_PACKET}}{\text{AOI_WIDTH} \times \text{AOI_HEIGHT} \times \text{ByteDepth} \times 125\mu\text{s}}$$

Formula 18: Maximum frame rate calculation

ByteDepth is based on the following values:

Mode	bit/pixel	byte per pixel
Mono8, Raw8	8	1
Mono12, Raw12	12	1.5
Mono16, Raw16	14	2
Mono16, Raw16 (High SNR mode)	16	2
YUV4:2:2	16	2
YUV4:1:1	12	1.5
RGB8	24	3

Table 105: ByteDepth

Example formula for the monochrome camera

Mono16, 1392 x 1040, 30 fps desired

$$\text{BYTE_PER_PACKET} = 30 \times 1392 \times 1040 \times 2 \times 125\mu\text{s} = 10856 > 8192$$

$$\Rightarrow \text{frame rate}_{\text{reachable}} \approx \frac{8192}{1392 \times 1040 \times 2 \times 125\mu\text{s}} = 22.64 \times \frac{1}{\text{s}}$$

Formula 19: Example maximum frame rate calculation

Test images

Loading test images

FirePackage	Fire4Linux
<ol style="list-style-type: none"> 1. Start SmartView. 2. Click the Edit settings button.  3. Click Adv1 tab. 4. In combo box Test images choose Image 1 or another test image. 	<ol style="list-style-type: none"> 1. Start cc1394 viewer. 2. In Adjustments menu click on Picture Control. 3. Click Main tab. 4. Activate Test image check box on. 5. In combo box Test images choose Image 1 or another test image.

Table 106: Loading test images in different viewers

Test images for monochrome cameras

Stingray monochrome cameras have two test images that look the same. Both images show a gray bar running diagonally.

- **Image 1** is static.
- **Image 2** moves upwards by 1 pixel/frame.

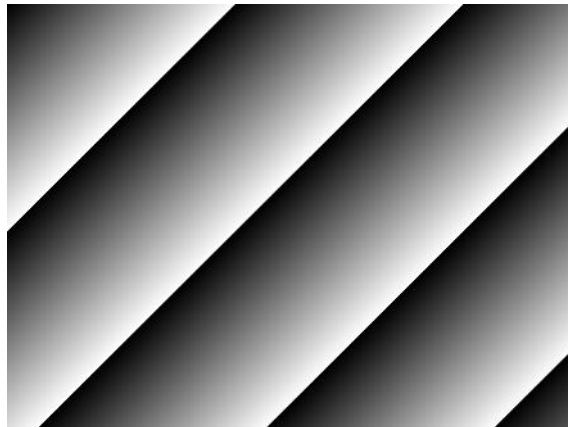

Figure 101: Gray bar test image

Test images for color cameras

The color cameras have 1 test image:

YUV4:2:2 mode



Figure 102: Color test image

Mono8 (raw data)

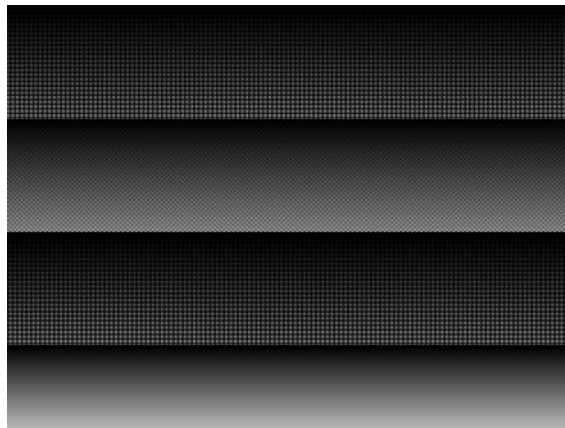

Figure 103: Bayer-coded test image

The color camera outputs Bayer-coded raw data in Mono8 instead of (as described in IIDC V1.31) a real Y signal.

Note

The first pixel of the image is always the red pixel from the sensor. (Mirror must be switched of)



Configuration of the camera

All camera settings are made by writing specific values into the corresponding registers.

This applies to:

- Values for general operating states such as video formats and modes, exposure times, etc.
- Extended features of the camera that are turned on and off and controlled via corresponding registers (so-called advanced registers).

Camera_Status_Register

The interoperability of cameras from different manufacturers is ensured by IIDC, formerly DCAM (Digital Camera Specification), published by the IEEE 1394 Trade Association.

IIDC is primarily concerned with setting memory addresses (e.g. CSR: Camera_Status_Register) and their meaning.

In principle, all addresses in IEEE 1394 networks are 64 bits long.

The first 10 bits describe the Bus_Id, the next 6 bits the Node_Id.

Of the subsequent 48 bit, the first 16 bit are always FFFFh; leaving the description for the Camera_Status_Register in the last 32 bit.

For example: If the CSR address is F0F00600h, this stands for:

Bus_Id, Node_Id, FFFF F0F00600h

Writing and reading to and from the register can be done with programs such as **FireView** or by other programs developed using an API library (e.g. **FirePackage**).

Every register is 32 bit (big endian) and implemented as follows (MSB = Most Significant Bit; LSB = Least Significant Bit):

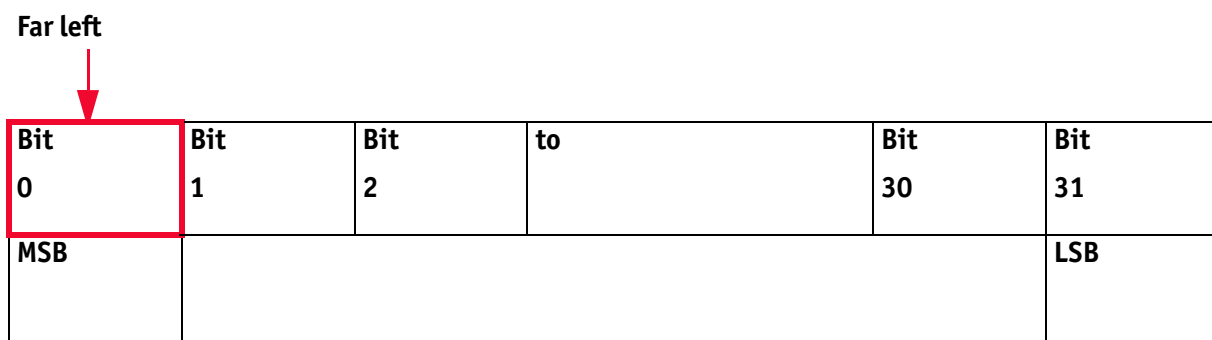
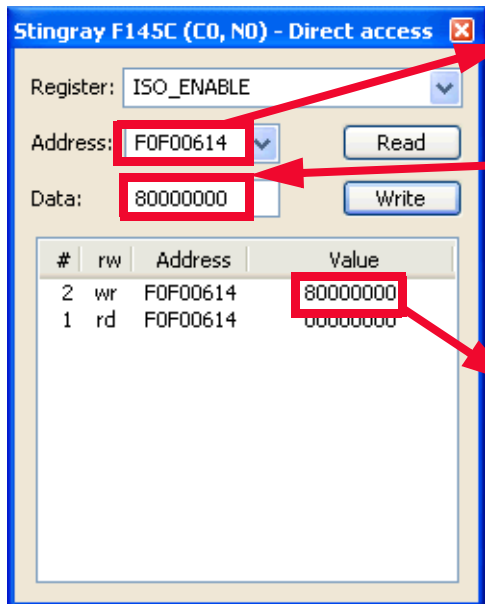

Figure 104: 32-bit register

Example

This requires, for example, that to enable **ISO_Enabled mode** (see chapter [ISO_Enabled / free-run](#) on page 200), (bit 0 in register 614h), the value 80000000 h must be written in the corresponding register.



Offset of Register: (0xF0F00614)
ISO_Enable

Write 80000000 and click **Write**

#	rw	Address	Value
2	wr	F0F00614	80000000
1	rd	F0F00614	00000000

Content of register: 80000000
= 1000 0000 0000 0000 0000 0000 0000 0000

Figure 105: Enabling ISO_Enable

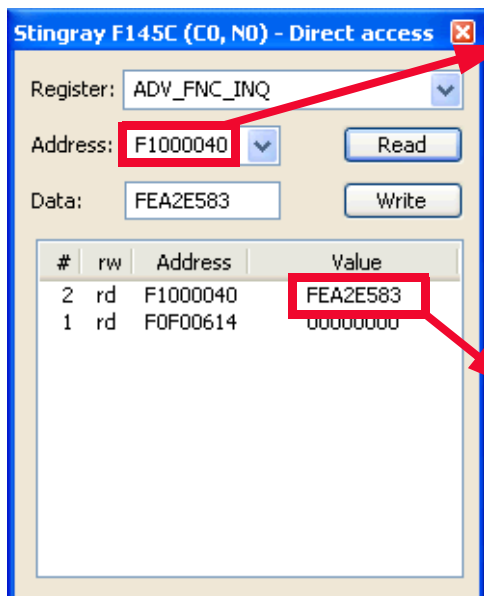

Offset of Register: (0xF1000040)
ADV_FNC_INQ

Content of register: FEA2E583
= 1111 1110 1010 0010 1110 0101 1000 0011

#	rw	Address	Value
2	rd	F1000040	FEA2E583
1	rd	F0F00614	00000000

Figure 106: Configuring the camera (Stingray F-145C)

	MaxResolution	TimeBase	ExtdShutter	Testimage				VersionInfo		Look-up tables	Shading	DeferredTrans			Trigger Delay	Misc. features
Bit	0	1	2	3	4	5	6	7	8	9	10	11	12	13	14	15
	1	1	1	1	1	1	1	0	1	0	1	0	0	0	1	0

	SoftReset	High SNR	Color-Corr		UserProfiles											GP_Buffer
Bit	16	17	18	19	20	21	22	23	24	25	26	27	28	29	30	31
	1	1	1	0	0	1	0	1	1	0	0	0	0	0	1	1

Table 107: Configuring the camera: registers

Sample program

The following sample code in C/C++ shows how the register is set for video mode/format, trigger mode, etc., using the **FireGrab** and **FireStack API**.

Example FireGrab

```

...
// Set Videoformat
if(Result==FCE_NOERROR)
    Result= Camera.SetParameter(FGP_IMAGEFORMAT,MAKEIMAGEFORMAT(RES_640_480,
CM_Y8, FR_15));

// Set external Trigger
if(Result==FCE_NOERROR)
    Result= Camera.SetParameter(FGP_TRIGGER,MAKETRIGGER(1,0,0,0,0));

// Start DMA logic
if(Result==FCE_NOERROR)
    Result=Camera.OpenCapture();

// Start image device
if(Result==FCE_NOERROR)
    Result=Camera.StartDevice();
...

```

Example FireStack API

```
...
// Set framerate

Result=WriteQuad(HIGHOFFSET,m_Props.CmdRegBase+CCR_FRAMERATE, (UINT32)m_Parms.Framerate<<29);

// Set mode
if(Result)

Result=WriteQuad(HIGHOFFSET,m_Props.CmdRegBase+CCR_VMODE, (UINT32)m_Parms.VideoMode<<29);

// Set format
if(Result)

Result=WriteQuad(HIGHOFFSET,m_Props.CmdRegBase+CCR_VFORMAT, (UINT32)m_Parms.VideoFormat<<29);

// Set trigger
if(Result)
{
Mode=0;
if(m_Parms.TriggerMode==TM_EXTERN)
Mode=0x82000000;
if(m_Parms.TriggerMode==TM_MODE15)
Mode=0x820F0000;
WriteQuad(HIGHOFFSET,m_Props.CmdRegBase+CCR_TRGMODE, Mode);
}

// Start continuous ISO if not oneshot triggermode
if(Result && m_Parms.TriggerMode!=TM_ONESHOT)
Result=WriteQuad(HIGHOFFSET,m_Props.CmdRegBase+CCR_ISOENABLE, 0x80000000);

...
```

Configuration ROM

The information in the **configuration ROM** is needed to identify the node, its capabilities, and the required drivers.

The base address for the **configuration ROM** for all registers is FFFF F000000h.

Note If you want to use the SmartView program to read or write to a register, enter the following value in the Address field:



F0F00000h + Offset

The **configuration ROM** is divided into the following:

- Bus info block: providing critical information about the bus-related capabilities
- Root directory: specifying the rest of the content and organization, such as:
 - Node unique ID leaf
 - Unit directory
 - Unit dependent info

The base address of the camera control register is calculated as follows based on the camera-specific base address:

Bus info block	Offset	0 to 7	8 to 15	16 to 23	24 to 31	
	400h	04	29	0C	C0	
	404h	31	33	39	34 ASCII for IEEE 1394
	408h	20	00	B2	03 Bus capabilities
	40Ch	00	0A	47	01 <i>Node_Vendor_Id</i> , <i>Chip_id_hi</i>
	410h	Serial number			 <i>Chip_id_lo</i>
Root directory	414h	00	04	B7	85	According to IEEE1212, the root directory may have another length. The keys (e.g. 8D) point to the offset factors rather than the offset (e.g. 420h) itself.
	418h	03	00	0A	47	
	41Ch	0C	00	83	C0	
	420h	8D	00	00	02	
	424h	D1	00	00	04	

Table 108: Configuration ROM

The entry with key 8D in the root directory (420h in this case) provides the offset for the Node unique ID leaf.

To compute the effective start address of the node unique ID leaf	
currAddr	= node unique ID leaf address
destAddr	= address of directory entry
addrOffset	= value of directory entry
destAddr	= currAddr + (4 x addrOffset)
	= 420h + (4 x 000002h)
	= 428h

Table 109: Computing effective start address

destAdr, calculated from the example in the table above:

$$420h + 000002h \times 4 = 428h$$

	Offset	0 to 7	8 to 15	16 to 23	24 to 31	
Node unique ID leaf	428h	00	02	5E	9E	to.CRC
	42Ch	00	0A	47	01Node_Vendor_Id,Chip_id_h i
	430h	00	00	Serial number		

Table 110: Configuration ROM

The entry with key D1 in the root directory (424h in this case) provides the offset for the unit directory as follows:

$$424h + 000004 \times 4 = 434h$$

	Offset	0 to 7	8 to 15	16 to 23	24 to 31
Unit directory	434h	00	03	93	7D
	438h	12	00	A0	2D
	43Ch	13	00	01	02
	440h	D4	00	00	01

Table 111: Configuration ROM

The entry with key D4 in the unit directory (440h in this case) provides the offset for unit dependent info:

$$440h + 0000xx \times 4 = 444h$$

	Offset	0 to 7	8 to 15	16 to 23	24 to 31	
 Unit dependent info	444h	00	0B	A9	6E	to.unit_dep_info_length, CRC
	448h	40	3C	00	00	to.command_regs_base
	44Ch	81	00	00	02	to.vender_name_leaf
	450h	82	00	00	06	to.model_name_leaf
	454h	38	00	00	10	to.unit_sub_sw_version
	458h	39	00	00	00	to.Reserved
	45Ch	3A	00	00	00	to.Reserved
	460h	3B	00	00	00	to.Reserved
	464h	3C	00	01	00	to.vendor_unique_info_0
	468h	3D	00	92	00	to.vendor_unique_info_1
	46Ch	3E	00	00	65	to.vendor_unique_info_2
	470h	3F	00	00	00	to.vendor_unique_info_3

Table 112: Configuration ROM

Finally, the entry with key 40 (448h in this case) provides the offset for the camera control register:

$$\text{FFFF F0000000h} + 3\text{C0000h} \times 4 = \text{FFFF F0F00000h}$$

The base address of the camera control register is thus:

$$\text{FFFF F0F00000h}$$

The offset entered in the table always refers to the base address of F0F00000h.

Implemented registers (IIDC V1.31)

The following tables show how standard registers from IIDC V1.31 are implemented in the camera:

- Base address is F0F00000h
- Differences and explanations can be found in the **Description** column.

Camera initialize register

Offset	Name	Description
000h	INITIALIZE	Assert MSB = 1 for Init.

Table 113: Camera initialize register

Inquiry register for video format

Offset	Name	Field	Bit	Description
100h	V_FORMAT_INQ	Format_0	[0]	Up to VGA (non compressed)
		Format_1	[1]	SVGA to XGA
		Format_2	[2]	SXGA to UXGA
		Format_3	[3 to 5]	Reserved
		Format_6	[6]	Still Image Format
		Format_7	[7]	Partial Image Format
		---	[8 to 31]	Reserved

Table 114: Format inquiry register

Inquiry register for video mode

Offset	Name	Field	Bit	Description	Color mode
180h	V_MODE_INQ (Format_0)	Mode_0	[0]	160 x 120	YUV 4:4:4
		Mode_1	[1]	320 x 240	YUV 4:2:2
		Mode_2	[2]	640 x 480	YUV 4:1:1
		Mode_3	[3]	640 x 480	YUV 4:2:2
		Mode_4	[4]	640 x 480	RGB
		Mode_5	[5]	640 x 480	MON08
		Mode_6	[6]	640 x 480	MON016
		Mode_X	[7]	Reserved	
		---	[8 to 31]	Reserved (zero)	
184h	V_MODE_INQ (Format_1)	Mode_0	[0]	800 x 600	YUV 4:2:2
		Mode_1	[1]	800 x 600	RGB
		Mode_2	[2]	800 x 600	MON08
		Mode_3	[3]	1024 x 768	YUV 4:2:2
		Mode_4	[4]	1024 x 768	RGB
		Mode_5	[5]	1024 x 768	MON08
		Mode_6	[6]	800 x 600	MON016
		Mode_7	[7]	1024 x 768	MON016
		---	[8 to 31]	Reserved (zero)	
188h	V_MODE_INQ (Format_2)	Mode_0	[0]	1280 x 960	YUV 4:2:2
		Mode_1	[1]	1280 x 960	RGB
		Mode_2	[2]	1280 x 960	MON08
		Mode_3	[3]	1600 x 1200	YUV 4:2:2
		Mode_4	[4]	1600 x 1200	RGB
		Mode_5	[5]	1600 x 1200	MON08
		Mode_6	[6]	1280 x 960	MON016
		Mode_7	[7]	1600 x 1200	MON016
		---	[8 to 31]	Reserved (zero)	
18Ch ... 197h	Reserved for other V_MODE_INQ_x for Format_x.			Always 0	
198h	V_MODE_INQ_6 (Format_6)			Always 0	

Table 115: Video mode inquiry register

Offset	Name	Field	Bit	Description	Color mode
19Ch	V_MODE_INQ (Format_7)	Mode_0	[0]	Format_7 Mode_0	
		Mode_1	[1]	Format_7 Mode_1	
		Mode_2	[2]	Format_7 Mode_2	
		Mode_3	[3]	Format_7 Mode_3	
		Mode_4	[4]	Format_7 Mode_4	
		Mode_5	[5]	Format_7 Mode_5	
		Mode_6	[6]	Format_7 Mode_6	
		Mode_7	[7]	Format_7 Mode_7	
		---	[8 to 31]	Reserved (zero)	

Table 115: Video mode inquiry register (continued)

Inquiry register for video frame rate and base address

Offset	Name	Field	Bit	Description
200h	V_RATE_INQ (Format_0, Mode_0)	FrameRate_0	[0]	Reserved
		FrameRate_1	[1]	Reserved
		FrameRate_2	[2]	7.5 fps
		FrameRate_3	[3]	15 fps
		FrameRate_4	[4]	30 fps
		FrameRate_5	[5]	60 fps
		FrameRate_6	[6]	120 fps (V1.31)
		FrameRate_7	[7]	240 fps (V1.31)
		---	[8 to 31]	Reserved (zero)
204h	V_RATE_INQ (Format_0, Mode_1)	FrameRate_0	[0]	1.875 fps
		FrameRate_1	[1]	3.75 fps
		FrameRate_2	[2]	7.5 fps
		FrameRate_3	[3]	15 fps
		FrameRate_4	[4]	30 fps
		FrameRate_5	[5]	60 fps
		FrameRate_6	[6]	120 fps (V1.31)
		FrameRate_7	[7]	240 fps (V1.31)
		---	[8 to 31]	Reserved (zero)

Table 116: Frame rate inquiry register

Offset	Name	Field	Bit	Description
208h	V_RATE_INQ (Format_0, Mode_2)	FrameRate_0	[0]	1.875 fps
		FrameRate_1	[1]	3.75 fps
		FrameRate_2	[2]	7.5 fps
		FrameRate_3	[3]	15 fps
		FrameRate_4	[4]	30 fps
		FrameRate_5	[5]	60 fps
		FrameRate_6	[6]	120 fps (V1.31)
		FrameRate_7	[7]	240 fps (V1.31)
		---	[8 to 31]	Reserved (zero)
20Ch	V_RATE_INQ (Format_0, Mode_3)	FrameRate_0	[0]	1.875 fps
		FrameRate_1	[1]	3.75 fps
		FrameRate_2	[2]	7.5 fps
		FrameRate_3	[3]	15 fps
		FrameRate_4	[4]	30 fps
		FrameRate_5	[5]	60 fps
		FrameRate_6	[6]	120 fps (V1.31)
		FrameRate_7	[7]	240 fps (V1.31)
		---	[8 to 31]	Reserved (zero)
210h	V_RATE_INQ (Format_0, Mode_4)	FrameRate_0	[0]	1.875 fps
		FrameRate_1	[1]	3.75 fps
		FrameRate_2	[2]	7.5 fps
		FrameRate_3	[3]	15 fps
		FrameRate_4	[4]	30 fps
		FrameRate_5	[5]	60 fps
		FrameRate_6	[6]	120 fps (V1.31)
		FrameRate_7	[7]	240 fps (V1.31)
		---	[8 to 31]	Reserved (zero)

Table 116: Frame rate inquiry register (continued)

Offset	Name	Field	Bit	Description
214h	V_RATE_INQ (Format_0, Mode_5)	FrameRate_0	[0]	1.875 fps
		FrameRate_1	[1]	3.75 fps
		FrameRate_2	[2]	7.5 fps
		FrameRate_3	[3]	15 fps
		FrameRate_4	[4]	30 fps
		FrameRate_5	[5]	60 fps
		FrameRate_6	[6]	120 fps (V1.31)
		FrameRate_7	[7]	240 fps (V1.31)
		---	[8 to 31]	Reserved (zero)
218h	V_RATE_INQ (Format_0, Mode_6)	FrameRate_0	[0]	1.875 fps
		FrameRate_1	[1]	3.75 fps
		FrameRate_2	[2]	7.5 fps
		FrameRate_3	[3]	15 fps
		FrameRate_4	[4]	30 fps
		FrameRate_5	[5]	60 fps
		FrameRate_6	[6]	120 fps (V1.31)
		FrameRate_7	[7]	240 fps (V1.31)
		---	[8 to 31]	Reserved (zero)
21Ch ... 21Fh	Reserved V_RATE_INQ_0_x (for other Mode_x of Format_0)			Always 0
220h	V_RATE_INQ (Format_1, Mode_0)	FrameRate_0	[0]	Reserved
		FrameRate_1	[1]	3.75 fps
		FrameRate_2	[2]	7.5 fps
		FrameRate_3	[3]	15 fps
		FrameRate_4	[4]	30 fps
		FrameRate_5	[5]	60 fps
		FrameRate_6	[6]	120 fps (V1.31)
		FrameRate_7	[7]	240 fps (V1.31)
		---	[8 to 31]	Reserved (zero)

Table 116: Frame rate inquiry register (continued)

Offset	Name	Field	Bit	Description
224h	V_RATE_INQ (Format_1, Mode_1)	FrameRate_0	[0]	Reserved
		FrameRate_1	[1]	Reserved
		FrameRate_2	[2]	7.5 fps
		FrameRate_3	[3]	15 fps
		FrameRate_4	[4]	30 fps
		FrameRate_5	[5]	60 fps
		FrameRate_6	[6]	120 fps (V1.31)
		FrameRate_7	[7]	240 fps (V1.31)
		---	[8 to 31]	Reserved (zero)
228h	V_RATE_INQ (Format_1, Mode_2)	FrameRate_0	[0]	Reserved
		FrameRate_1	[1]	Reserved
		FrameRate_2	[2]	7.5 fps
		FrameRate_3	[3]	15 fps
		FrameRate_4	[4]	30 fps
		FrameRate_5	[5]	60 fps
		FrameRate_6	[6]	120 fps (V1.31)
		FrameRate_7	[7]	240 fps (V1.31)
		---	[8 to 31]	Reserved (zero)
22Ch	V_RATE_INQ (Format_1, Mode_3)	FrameRate_0	[0]	1.875 fps
		FrameRate_1	[1]	3.75 fps
		FrameRate_2	[2]	7.5 fps
		FrameRate_3	[3]	15 fps
		FrameRate_4	[4]	30 fps
		FrameRate_5	[5]	60 fps
		FrameRate_6	[6]	120 fps (V1.31)
		FrameRate_7	[7]	240 fps (V1.31)
		---	[8 to 31]	Reserved (zero)

Table 116: Frame rate inquiry register (continued)

Offset	Name	Field	Bit	Description
230h	V_RATE_INQ (Format_1, Mode_4)	FrameRate_0	[0]	1.875 fps
		FrameRate_1	[1]	3.75 fps
		FrameRate_2	[2]	7.5 fps
		FrameRate_3	[3]	15 fps
		FrameRate_4	[4]	30 fps
		FrameRate_5	[5]	60 fps
		FrameRate_6	[6]	120 fps (V1.31)
		FrameRate_7	[7]	240 fps (V1.31)
		---	[8 to 31]	Reserved (zero)
234h	V_RATE_INQ (Format_1, Mode_5)	FrameRate_0	[0]	1.875 fps
		FrameRate_1	[1]	3.75 fps
		FrameRate_2	[2]	7.5 fps
		FrameRate_3	[3]	15 fps
		FrameRate_4	[4]	30 fps
		FrameRate_5	[5]	60 fps
		FrameRate_6	[6]	120 fps (V1.31)
		FrameRate_7	[7]	240 fps (V1.31)
		---	[8 to 31]	Reserved (zero)
238h	V_RATE_INQ (Format_1, Mode_6)	FrameRate_0	[0]	1.875 fps
		FrameRate_1	[1]	3.75 fps
		FrameRate_2	[2]	7.5 fps
		FrameRate_3	[3]	15 fps
		FrameRate_4	[4]	30 fps
		FrameRate_5	[5]	60 fps
		FrameRate_6	[6]	120 fps (V1.31)
		FrameRate_7	[7]	240 fps (V1.31)
		---	[8 to 31]	Reserved (zero)

Table 116: Frame rate inquiry register (continued)

Offset	Name	Field	Bit	Description
23Ch	V_RATE_INQ (Format_1, Mode_7)	FrameRate_0	[0]	1.875 fps
		FrameRate_1	[1]	3.75 fps
		FrameRate_2	[2]	7.5 fps
		FrameRate_3	[3]	15 fps
		FrameRate_4	[4]	30 fps
		FrameRate_5	[5]	60 fps
		FrameRate_6	[6]	120 fps (V1.31)
		FrameRate_7	[7]	Reserved
		---	[8 to 31]	Reserved (zero)
240h	V_RATE_INQ (Format_2, Mode_0)	FrameRate_0	[0]	1.875 fps
		FrameRate_1	[1]	3.75 fps
		FrameRate_2	[2]	7.5 fps
		FrameRate_3	[3]	15 fps
		FrameRate_4	[4]	30 fps
		FrameRate_5	[5]	60 fps
		FrameRate_6	[6]	Reserved
		FrameRate_7	[7]	Reserved
		---	[8 to 31]	Reserved (zero)
244h	V_RATE_INQ (Format_2, Mode_1)	FrameRate_0	[0]	1.875 fps
		FrameRate_1	[1]	3.75 fps
		FrameRate_2	[2]	7.5 fps
		FrameRate_3	[3]	15 fps
		FrameRate_4	[4]	30 fps
		FrameRate_5	[5]	60 fps
		FrameRate_6	[6]	Reserved
		FrameRate_7	[7]	Reserved
		---	[8 to 31]	Reserved (zero)

Table 116: Frame rate inquiry register (continued)

Offset	Name	Field	Bit	Description
248h	V_RATE_INQ (Format_2, Mode_2)	FrameRate_0	[0]	1.875 fps
		FrameRate_1	[1]	3.75 fps
		FrameRate_2	[2]	7.5 fps
		FrameRate_3	[3]	15 fps
		FrameRate_4	[4]	30 fps
		FrameRate_5	[5]	60 fps
		FrameRate_6	[6]	120 fps (V1.31)
		FrameRate_7	[7]	Reserved
		---	[8 to 31]	Reserved (zero)
24Ch	V_RATE_INQ (Format_2, Mode_3)	FrameRate_0	[0]	1.875 fps
		FrameRate_1	[1]	3.75 fps
		FrameRate_2	[2]	7.5 fps
		FrameRate_3	[3]	15 fps
		FrameRate_4	[4]	30 fps
		FrameRate_5	[5]	60 fps
		FrameRate_6	[6]	Reserved
		FrameRate_7	[7]	Reserved
		---	[8 to 31]	Reserved (zero)
250h	V_RATE_INQ (Format_2, Mode_4)	FrameRate_0	[0]	1.875 fps
		FrameRate_1	[1]	3.75 fps
		FrameRate_2	[2]	7.5 fps
		FrameRate_3	[3]	15 fps
		FrameRate_4	[4]	30 fps
		FrameRate_5	[5]	Reserved
		FrameRate_6	[6]	Reserved
		FrameRate_7	[7]	Reserved
		---	[8 to 31]	Reserved (zero)

Table 116: Frame rate inquiry register (continued)

Offset	Name	Field	Bit	Description
254h	V_RATE_INQ (Format_2, Mode_5)	FrameRate_0	[0]	1.875 fps
		FrameRate_1	[1]	3.75 fps
		FrameRate_2	[2]	7.5 fps
		FrameRate_3	[3]	15 fps
		FrameRate_4	[4]	30 fps
		FrameRate_5	[5]	60 fps
		FrameRate_6	[6]	Reserved
		FrameRate_7	[7]	Reserved
		---	[8 to 31]	Reserved (zero)
258h	V_RATE_INQ (Format_2, Mode_6)	FrameRate_0	[0]	1.875 fps
		FrameRate_1	[1]	3.75 fps
		FrameRate_2	[2]	7.5 fps
		FrameRate_3	[3]	15 fps
		FrameRate_4	[4]	30 fps
		FrameRate_5	[5]	60 fps
		FrameRate_6	[6]	Reserved
		FrameRate_7	[7]	Reserved
		---	[8 to 31]	Reserved (zero)
25Ch	V_RATE_INQ (Format_2, Mode_7)	FrameRate_0	[0]	1.875 fps
		FrameRate_1	[1]	3.75 fps
		FrameRate_2	[2]	7.5 fps
		FrameRate_3	[3]	15 fps
		FrameRate_4	[4]	30 fps
		FrameRate_5	[5]	60 fps
		FrameRate_6	[6]	Reserved
		FrameRate_7	[7]	Reserved
		---	[8 to 31]	Reserved
260h ... 2BFh	Reserved V_RATE_INQ_y_x (for other Format_y, Mode_x)			
2C0h	V_REV_INQ_6_0 (Format_6, Mode0)			Always 0
2C4h to 2DFh	Reserved V_REV_INQ_6_x (for other Mode_x of Format_6)			Always 0

Table 116: Frame rate inquiry register (continued)

Offset	Name	Field	Bit	Description
2E0h	V-CSR_INQ_7_0		[0 to 31]	CSR_quadlet offset for Format_7 Mode_0
2E4h	V-CSR_INQ_7_1		[0 to 31]	CSR_quadlet offset for Format_7 Mode_1
2E8h	V-CSR_INQ_7_2		[0 to 31]	CSR_quadlet offset for Format_7 Mode_2
2ECh	V-CSR_INQ_7_3		[0 to 31]	CSR_quadlet offset for Format_7 Mode_3
2F0h	V-CSR_INQ_7_4		[0 to 31]	CSR_quadlet offset for Format_7 Mode_4
2F4h	V-CSR_INQ_7_5		[0 to 31]	CSR_quadlet offset for Format_7 Mode_5
2F8h	V-CSR_INQ_7_6		[0 to 31]	CSR_quadlet offset for Format_7 Mode_6
2FCh	V-CSR_INQ_7_7		[0 to 31]	CSR_quadlet offset for Format_7 Mode_7

Table 116: Frame rate inquiry register (continued)

Inquiry register for basic function

Offset	Name	Field	Bit	Description
400h	BASIC_FUNC_INQ	Advanced_Feature_Inq	[0]	Inquiry for advanced features (Vendor unique Features)
		Vmode_Error_Status_Inq	[1]	Inquiry for existence of Vmode_Error_Status register
		Feature_Control_Error_Status_Inq	[2]	Inquiry for existence of Feature_Control_Error_Status
		Opt_Func_CSR_Inq	[3]	Inquiry for Opt_Func_CSR
		---	[4 to 7]	Reserved
		1394b_mode_Capability	[8]	Inquiry for 1394b_mode_Capability
		---	[9 to 15]	Reserved
		Cam_Power_Cntl	[16]	Camera process power ON/OFF capability
		---	[17 to 18]	Reserved
		One_Shot_Inq	[19]	One-shot transmission capability
		Multi_Shot_Inq	[20]	Multi-shot transmission capability
		---	[21 to 27]	Reserved
		Memory_Channel	[28 to 31]	Maximum memory channel number (N) If 0000, no user memory available

Table 117: Basic function inquiry register

Inquiry register for feature presence

Offset	Name	Field	Bit	Description
404h	FEATURE_HI_INQ	Brightness	[0]	Brightness control
		Auto_Exposure	[1]	Auto_Exposure control
		Sharpness	[2]	Sharpness control
		White_Balance	[3]	White balance control
		Hue	[4]	Hue control
		Saturation	[5]	Saturation control
		Gamma	[6]	Gamma control
		Shutter	[7]	Shutter control
		Gain	[8]	Gain control
		Iris	[9]	Iris control
		Focus	[10]	Focus control
		Temperature	[11]	Temperature control
		Trigger	[12]	Trigger control
		Trigger_Delay	[13]	Trigger_Delay control
		White_Shading	[14]	White_Shading control
Frame_Rate	[15]	Frame_Rate control		
	---	[16 to 31]	Reserved	
408h	FEATURE_LO_INQ	Zoom	[0]	Zoom control
		Pan	[1]	Pan control
		Tilt	[2]	Tilt control
		Optical_Filter	[3]	Optical_Filter control
		---	[4 to 15]	Reserved
		Capture_Size	[16]	Capture_Size for Format_6
		Capture_Quality	[17]	Capture_Quality for Format_6
		---	[16 to 31]	Reserved
40Ch	OPT_FUNCTION_INQ	---	[0]	Reserved
		PIO	[1]	Parallel Input/Output control
		SIO	[2]	Serial Input/Output control
		Strobe_out	[4 to 31]	Strobe signal output

Table 118: Feature presence inquiry register

Offset	Name	Field	Bit	Description
410h to 47Fh	Reserved			Address error on access
480h	Advanced_Feature_Inq	Advanced_Feature_Quadlet_Offset	[0 to 31]	<p>Quadlet offset of the advanced feature CSR's from the base address of initial register space (vendor unique)</p> <p>This register is the offset for the Access_Control_Register and thus the base address for Advanced Features.</p> <p>Access_Control_Register does not prevent access to advanced features. In some programs it should still always be activated first.</p> <p>Advanced Feature Set Unique Value is 7ACh and CompanyID is A47h.</p>
484h	PIO_Control_CSR_Inq	PIO_Control_Quadlet_Offset	[0 to 31]	Quadlet offset of the PIO_Control CSR's from the base address of initial register space (Vendor unique)
488h	SIO_Control_CSR_Inq	SIO_Control_Quadlet_Offset	[0 to 31]	Quadlet offset of the SIO_Control CSR's from the base address of initial register space (vendor unique)
48Ch	Strobe_Output_CSR_Inq	Strobe_Output_Quadlet_Offset	[0 to 31]	Quadlet offset of the Strobe_Output signal CSR's from the base address of initial register space (vendor unique)

Table 118: Feature presence inquiry register (continued)

Inquiry register for feature elements

Register	Name	Field	Bit	Description
0xF0F00500	BRIGHTNESS_INQUIRY	Presence_Inq	[0]	Indicates presence of this feature (read only)
		Abs_Control_Inq	[1]	Capability of control with absolute value
		---	[2]	Reserved
		One_Push_Inq	[3]	One-push auto mode (controlled automatically by the camera once)
		Readout_Inq	[4]	Capability of reading out the value of this feature
		ON_OFF	[5]	Capability of switching this feature ON and OFF
		Auto_Inq	[6]	Auto Mode (Controlled automatically by the camera)
		Manual_Inq	[7]	Manual Mode (Controlled by user)
		Min_Value	[8 to 19]	Minimum value for this feature
		Max_Value	[20 to 31]	Maximum value for this feature
504h	AUTO_EXPOSURE_INQ	Same definition as Brightness_inq.		
508h	SHARPNESS_INQ	Same definition as Brightness_inq.		
50Ch	WHITE_BAL_INQ	Same definition as Brightness_inq.		
510h	HUE_INQ	Same definition as Brightness_inq.		
514h	SATURATION_INQ	Same definition as Brightness_inq.		
518h	GAMMA_INQ	Same definition as Brightness_inq.		
51Ch	SHUTTER_INQ	Same definition as Brightness_inq.		
520h	GAIN_INQ	Same definition as Brightness_inq.		
524h	IRIS_INQ	Always 0		
528h	FOCUS_INQ	Always 0		
52Ch	TEMPERATURE_INQ	Same definition as Brightness_inq.		

Table 119: Feature elements inquiry register

Register	Name	Field	Bit	Description
530h	TRIGGER_INQ	Presence_Inq	[0]	Indicates presence of this feature (read only)
		Abs_Control_Inq	[1]	Capability of control with absolute value
		---	[2 to 3]	Reserved
		Readout_Inq	[4]	Capability of reading out the value of this feature
		ON_OFF	[5]	Capability of switching this feature ON and OFF
		Polarity_Inq	[6]	Capability of changing the polarity of the trigger input
		Value_Read_Inq	[7]	Capability of reading raw trigger input Reads if trigger is active. In case of external trigger, a combined signal is read.
		Trigger_Source0_Inq	[8]	Presence of Trigger Source 0 ID=0 Indicates usage of standard inputs.
		---	[9 to 15]	Reserved
		Software_Trigger_Inq	[15]	Presence of Software Trigger ID=7
		Trigger_Mode0_Inq	[16]	Presence of Trigger_Mode 0
		Trigger_Mode1_Inq	[17]	Presence of Trigger_Mode 1
		Trigger_Mode2_Inq	[18]	Presence of Trigger_Mode 2
		Trigger_Mode3_Inq	[19]	Presence of Trigger_Mode 3
---	[20 to 31]	Reserved		

Table 119: Feature elements inquiry register (continued)

Register	Name	Field	Bit	Description
534h	TRIGGER_DELAY_INQUIRY	Presence_Inq	[0]	Indicates presence of this feature (read only)
		Abs_Control_Inq	[1]	Capability of control with absolute value
		---	[2]	Reserved
		One_Push_Inq	[3]	One Push auto mode Controlled automatically by the camera once)
		Readout_Inq	[4]	Capability of reading out the value of this feature
		ON_OFF	[5]	Capability of switching this feature ON and OFF
		Auto_Inq	[6]	Auto Mode (Controlled automatically by the camera)
		Manual_Inq	[7]	Manual Mode (Controlled by user)
		Min_Value	[8 to 19]	Minimum value for this feature
Max_Value	[20 to 31]	Maximum value for this feature		
538 to 57Ch	Reserved for other FEATURE_HI_INQ			
580h	ZOOM_INQ	Always 0		
584h	PAN_INQ	Always 0		
588h	TILT_INQ	Always 0		
58Ch	OPTICAL_FILTER_INQ	Always 0		
590 to 5BCh	Reserved for other FEATURE_LO_INQ	Always 0		
5C0h	CAPTURE_SIZE_INQ	Always 0		
5C4h	CAPTURE_QUALITY_INQ	Always 0		
5C8h to 5FCh	Reserved for other FEATURE_LO_INQ	Always 0		

Table 119: Feature elements inquiry register (continued)

Status and control registers for camera

Register	Name	Field	Bit	Description
600h	CUR-V-Frm_RATE/ Revision	Bit [0 to 2] for the frame rate		
604h	CUR-V-MODE	Bit [0 to 2] for the current video mode		
608h	CUR-V-FORMAT	Bit [0 to 2] for the current video format		
60Ch	ISO-Channel	Bit [0 to 3] for channel, [6 to 7] for ISO speed		
610h	Camera_Power	Always 0		
614h	ISO_EN/ Continuous_Shot	Bit 0: 1 for start continuous shot; 0 for stop continuous shot		
618h	Memory_Save	Always 0		
61Ch	One_Shot, Multi_Shot, Count Number	See chapter One-shot on page 197 See chapter Multi-shot on page 200		
620h	Mem_Save_Ch	Always 0		
624	Cur_Mem_Ch	Always 0		
628h	Vmode_Error_Status	Error in combination of Format/Mode/ISO Speed: Bit(0): No error; Bit(0)=1: error		
62Ch	Software_Trigger	Software trigger Write: 0: Reset software trigger 1: Set software trigger (self cleared, when using edge mode; must be set back to 0 manually, when using level mode) Read: 0: Ready (meaning: it's possible to set a software trigger) 1: Busy (meaning: no trigger possible)		

Table 120: Status and control registers for camera

Inquiry register for absolute value CSR offset address

Offset	Name	Description
700h	ABS_CSR_HI_INQ_0	Always 0
704h	ABS_CSR_HI_INQ_1	Always 0
708h	ABS_CSR_HI_INQ_2	Always 0
70Ch	ABS_CSR_HI_INQ_3	Always 0
710h	ABS_CSR_HI_INQ_4	Always 0
714h	ABS_CSR_HI_INQ_5	Always 0
718h	ABS_CSR_HI_INQ_6	Always 0
71Ch	ABS_CSR_HI_INQ_7	Always 0
720h	ABS_CSR_HI_INQ_8	Always 0
724h	ABS_CSR_HI_INQ_9	Always 0
728h	ABS_CSR_HI_INQ_10	Always 0
72Ch	ABS_CSR_HI_INQ_11	Always 0
730h	ABS_CSR_HI_INQ_12	Always 0
734 to 77Fh	Reserved	Always 0
780h	ABS_CSR_LO_INQ_0	Always 0
784h	ABS_CSR_LO_INQ_1	Always 0
788h	ABS_CSR_LO_INQ_2	Always 0
78Ch	ABS_CSR_LO_INQ_3	Always 0
790h to 7BFh	Reserved	Always 0
7C0h	ABS_CSR_LO_INQ_16	Always 0
7C4h	ABS_CSR_LO_INQ_17	Always 0
7C8h to 7FFh	Reserved	Always 0

Table 121: Absolute value inquiry register

Status and control register for one-push

The **OnePush** feature, WHITE_BALANCE, is currently implemented. If this flag is set, the feature becomes immediately active, even if no images are being input (see chapter [One-push white balance](#) on page 129).

Offset	Name	Field	Bit	Description
800h	BRIGHTNESS	Presence_Inq	[0]	Presence of this feature 0: N/A 1: Available
		Abs_Control	[1]	Absolute value control 0: Control with value in the Value field 1: Control with value in the Absolute value CSR If this bit = 1, value in the Value field is ignored
		---	[2 to 4]	Reserved
		One_Push	[5]	Write 1: begin to work (Self cleared after operation) Read: Value=1 in operation Value=0 not in operation If A_M_Mode =1, this bit is ignored
		ON_OFF	[6]	Write: ON or OFF this feature Read: read a status 0: OFF, 1: ON If this bit =0, other fields will be read only
		A_M_Mode	[7]	Write: set the mode Read: read a current mode 0: Manual 1: Auto
		---	[8 to 19]	Reserved
		Value	[20 to 31]	Value. Write the value in Auto mode, this field is ignored If ReadOut capability is not available, read value has no meaning

Table 122: Feature control register

Offset	Name	Field	Bit	Description
804h	AUTO-EXPOSURE			See above Target grey level parameter in SmartView corresponds to Auto_exposure register 0xF0F00804 (I IDC)
808h	SHARPNESS			See above
80Ch	WHITE-BALANCE	Presence_Inq	[0]	Presence of this feature 0: N/A 1: Available Always 0 for Monochrome
		Abs_Control	[1]	Absolute value control 0: Control with value in the Value field 1: Control with value in the Absolute value CSR If this bit = 1, value in the Value field is ignored
		---	[2 to 4]	Reserved
		One_Push	[5]	Write 1: begin to work (Self cleared after operation) Read: Value=1 in operation Value=0 not in operation If A_M_Mode=1, this bit is ignored
		ON_OFF	[6]	Write: ON or OFF this feature, Read: read a status 0: OFF 1: ON If this bit =0, other fields will be read only
		A_M_Mode	[7]	Write: set the mode Read: read a current mode 0: Manual 1: Auto
		U_Value / B_Value	[8 to 19]	U value / B value Write the value in AUTO mode, this field is ignored If ReadOut capability is not available, read value has no meaning

Table 122: Feature control register (continued)

Offset	Name	Field	Bit	Description
		V_Value / R_Value	[20 to 31]	V value / R value Write the value in AUTO mode, this field is ignored If ReadOut capability is not available, read value has no meaning
810h	HUE			See above Always 0 for Monochrome
814h	SATURATION			See above Always 0 for Monochrome
818h	GAMMA			See above
81Ch	SHUTTER			See Advanced Feature time base: <ul style="list-style-type: none"> • see chapter Exposure time (shutter) and offset on page 194 • see chapter Time base on page 293 See Table 43 on page 132
820h	GAIN			See above
824h	IRIS			Always 0
828h	FOCUS			Always 0
82Ch	TEMPERATURE			See Table 125 on page 284
830h	TRIGGER_MODE			Can be effected via advanced feature IO_INP_CTRLx
834h to 87Ch	Reserved for other FEATURE_HI			Always 0
880h	Zoom			Always 0
884h	PAN			Always 0
888h	TILT			Always 0

Table 122: Feature control register (continued)

Offset	Name	Field	Bit	Description
88Ch	OPTICAL_FILTER			Always 0
890h to 8BCh	Reserved for other FEATURE_LO			Always 0
8C0h	CAPTURE-SIZE			Always 0
8C4h	CAPTURE-QUALITY			Always 0
8C8h to 8FCh	Reserved for other FEATURE_LO			Always 0

Table 122: Feature control register (continued)

Feature control error status register

Offset	Name	Description
640h	Feature_Control_Error_Status_HI	Always 0
644h	Feature_Control_Error_Status_LO	Always 0

Table 123: Feature control error register

Video mode control and status registers for Format_7

Quadlet offset Format_7 Mode_0

The quadlet offset to the base address for **Format_7 Mode_0**, which can be read out at F0F002E0h (according to [Table 116](#) on page 262) gives 003C2000h.

$4 \times 3C2000h = F08000h$ so that the base address for the latter ([Table 124](#) on page 283) equals

$F0000000h + F08000h = F0F08000h$.

Quadlet offset Format_7 Mode_1

The quadlet offset to the base address for **Format_7 Mode_1**, which can be read out at F0F002E4h (according to [Table 116](#) on page 262) gives 003C2400h.

$4 \times 003C2400h = F09000h$ so that the base address for the latter ([Table 124](#) on page 283) equals

$F0000000h + F09000h = F0F09000h$.

Format_7 control and status register (CSR)

Offset	Name	Description
000h	MAX_IMAGE_SIZE_INQ	According to IIDC V1.31
004h	UNIT_SIZE_INQ	According to IIDC V1.31
008h	IMAGE_POSITION	According to IIDC V1.31
00Ch	IMAGE_SIZE	According to IIDC V1.31
010h	COLOR_CODING_ID	See note
014h	COLOR_CODING_INQ	According to IIDC V1.31
024h . . 033h	COLOR_CODING_INQ	Vendor Unique Color_Coding 0-127 (ID=128 to 255) ID=132ECCID_MONO12 ID=136ECCID_RAW12 ID=133Reserved ID=134Reserved ID=135Reserved See chapter Packed 12-Bit Mode on page 170.
034h	PIXEL_NUMER_INQ	According to IIDC V1.31
038h	TOTAL_BYTES_HI_INQ	According to IIDC V1.31
03Ch	TOTAL_BYTES_LO_INQ	According to IIDC V1.31
040h	PACKET_PARA_INQ	See note
044h	BYTE_PER_PACKET	According to IIDC V1.31

Table 124: Format_7 control and status register

Note

- For all modes in Format_7, **ErrorFlag_1** and **ErrorFlag_2** are refreshed on each access to the Format_7 register.
- Contrary to IIDC V1.31, registers relevant to Format_7 are refreshed on each access. The **Setting_1** bit is automatically cleared after each access.
- When **ErrorFlag_1** or **ErrorFlag_2** are set and Format_7 is configured, no image capture is started.
- Contrary to IIDC V1.31, COLOR_CODING_ID is set to a default value after an INITIALIZE or **reset**.
- Contrary to IIDC V1.31, the **UnitBytePerPacket** field is already filled in with a fixed value in the PACKET_PARA_INQ register.

Temperature register

The temperature is implemented with Presence_Inq=1 (available) and ON_OFF [6] always ON according to IIDC V1.31:

Register	Name	Field	Bit	Description
0xF0F0082C	TEMPERATURE	Presence_Inq	[0]	Presence of this feature: 0: N/A 1: Available
		Abs_Control	[1]	Absolute value control 0: Control with value in the value field 1: Control with value in the absolute value CSR If this bit=1 the value in the value field has to be ignored.
		---	[2 to 5]	Reserved
		ON_OFF	[6]	Write: ON or OFF this feature Always 1 0: OFF 1: ON
		---	[7 to 19]	Reserved
		Value	[20 to 31]	Temperature at the present time (read only) Read out temperature value and divide by 10: this is the temperature at sensor in degree Celsius. Info: 50 °C at sensor is approximately 45 °C at camera housing. So never run the camera with more than 50 °C at sensor. <ul style="list-style-type: none"> • Minimum displayed temperature: -55 °C • Maximum displayed temperature: 150 °C • Increment: 0.25 °C/step

Table 125: CSR: Temperature

From -10 °C to +65 °C the temperature accuracy is: +1.5 °C / -2.0 °C

Advanced features (Allied Vision-specific)

The camera has a variety of extended features going beyond the possibilities described in IIDC V1.31. The following chapter summarizes all available (Allied Vision-specific) advanced features in ascending register order.

Note This chapter is a reference guide for advanced registers and does not explain the advanced features itself.



For detailed description of the theoretical background see

- chapter [Description of the data path](#) on page 125
- Links given in the table below

Advanced registers summary

The following table gives an overview of **all available advanced registers**:

Register	Register name	Description
0xF1000010	VERSION_INF01	See Table 127 on page 288
0xF1000014	VERSION_INF01_EX	
0xF1000018	VERSION_INF03	
0xF100001C	VERSION_INF03_EX	
0xF1000040	ADV_INQ_1	See Table 129 on page 290
0xF1000044	ADV_INQ_2	In ADV_INQ_3 there is a new field F7MODE_MAPPING [3] Low Noise Binning [9]
0xF1000048	ADV_INQ_3	
0xF100004C	ADV_INQ_4	
0xF1000100	CAMERA_STATUS	See Table 130 on page 292
0xF1000200	MAX_RESOLUTION	See Table 131 on page 293
0xF1000208	TIMEBASE	See Table 132 on page 293
0xF100020C	EXTD_SHUTTER	See Table 134 on page 295
0xF1000210	TEST_IMAGE	See Table 136 on page 299
0xF1000220	SEQUENCE_CTRL	See Table 74 on page 205
0xF1000224	SEQUENCE_PARAM	
0xF1000228	SEQUENCE_STEP	
0xF1000240	LUT_CTRL	See Table 137 on page 300
0xF1000244	LUT_MEM_CTRL	
0xF1000248	LUT_INFO	

Table 126: Advanced registers summary

Register	Register name	Description
0xF1000250	SHDG_CTRL	See Table 138 on page 302
0xF1000254	SHDG_MEM_CTRL	
0xF1000258	SHDG_INFO	
0xF1000260	DEFERRED_TRANS	See Table 140 on page 305
0xF1000270	FRAMEINFO	See Table 141 on page 305
0xF1000274	FRAMECOUNTER	
0xF1000298	DPC_CTRL	See Table 142 on page 306
0xF100029C	DPC_MEM	
0xF10002A0	DPC_INFO	
0xF1000300	IO_INP_CTRL1	Stingray housing and board level cameras See Table 23 on page 108
0xF1000304	IO_INP_CTRL2	
0xF1000320	IO_OUTP_CTRL1	Stingray housing and board level cameras See Table 29 on page 113
0xF1000324	IO_OUTP_CTRL2	
0xF1000328	IO_OUTP_CTRL3	
0xF100032C	IO_OUTP_CTRL4	
0xF1000340	IO_INTENA_DELAY	
0xF1000360	AUTOSHUTTER_CTRL	See Table 144 on page 309
0xF1000364	AUTOSHUTTER_LO	
0xF1000368	AUTOSHUTTER_HI	
0xF1000370	AUTOGAIN_CTRL	See Table 145 on page 311
0xF1000390	AUTOFNC_AOI	See Table 146 on page 312
0xF1000394	AF_AREA_POSITION	
0xF1000398	AF_AREA_SIZE	
0xF10003A0	COLOR_CORR	Stingray color cameras only See Table 147 on page 313
0xF10003A4	COLOR_CORR_COEFFIC11 = Crr	Stingray color cameras only See Table 147 on page 313
0xF10003A8	COLOR_CORR_COEFFIC12 = Cgr	
0xF10003AC	COLOR_CORR_COEFFIC13 = Cbr	
0xF10003B0	COLOR_CORR_COEFFIC21 = Crg	
0xF10003B4	COLOR_CORR_COEFFIC22 = Cgg	
0xF10003B8	COLOR_CORR_COEFFIC23 = Cbg	
0xF10003BC	COLOR_CORR_COEFFIC31 = Crb	
0xF10003C0	COLOR_CORR_COEFFIC32 = Cgb	
0xF10003C4	COLOR_CORR_COEFFIC33 = Cbb	

Table 126: Advanced registers summary (continued)

Register	Register name	Description
0xF1000400	TRIGGER_DELAY	See Table 148 on page 314
0xF1000410	MIRROR_IMAGE	See Table 138 on page 302
0xF1000510	SOFT_RESET	See Table 150 on page 315
0xF1000520	HIGH_SNR	See Table 151 on page 316
0xF1000550	USER_PROFILES	See Table 166 on page 331
0xF1000570	PARAMUPD_TIMING	See Table 154 on page 319
0xF1000580	F7MODE_MAPPING	See Table 157 on page 322
0xF1000610	FRMCNT_STAMP	See Table 162 on page 327
0xF1000620	TRIGGER_COUNTER	See Table 163 on page 328
0xF1000630	SIS	See Table 159 on page 324
0xF1000640	SWFEATURE_CTRL	See Table 165 on page 330
0xF1000800 0xF1000804	IO_OUTP_PWM1	Stingray housing and board level cameras: See Table 31 on page 116
0xF1000808 0xF100080C	IO_OUTP_PWM2	
0xF1000810 0xF1000814	IO_OUTP_PWM3	
0xF1000818 0xF100081C	IO_OUTP_PWM4	
0xF1000840	IO_INP_DEBOUNCE_1	
0xF1000850	IO_INP_DEBOUNCE_2	See Table 66 on page 194
0xF1000860	IO_INP_DEBOUNCE_3	
0xF1000870	IO_INP_DEBOUNCE_4	
0xF1000FFC	GPDATA_INFO	
0xF1001000 to 0xF100nnnn	GPDATA_BUFFER	See Table 169 on page 334
0xF1100000	PARRAMLIST_INFO	See Table 155 on page 321
0xF1101000	PARAMLIST_BUFFER	

Table 126: Advanced registers summary (continued)

Note



- Advanced features should always be activated before accessing them.
- Currently, all registers can be written without being activated. This makes it easier to operate the camera using **Directcontrol**.

Extended version information register

The presence of each of the following features can be queried by the **0** bit of the corresponding register.

Register	Name	Field	Bit	Description
0xF1000010	VERSION_INFO1	µC type ID	[0 to 15]	Always 0
		µC version	[16 to 31]	Bcd-coded version number
0xF1000014	VERSION_INFO1_EX	µC version	[0 to 31]	Bcd-coded version number
0xF1000018	VERSION_INFO3	Camera type ID	[0 to 15]	See Table 128 on page 289.
		FPGA version	[16 to 31]	Bcd-coded version number
0xF100001C	VERSION_INFO3_EX	FPGA version	[0 to 31]	Bcd-coded version number
0xF1000020		---	[0 to 31]	Reserved
0xF1000024		---	[0 to 31]	Reserved
0xF1000028		---	[0 to 31]	Reserved
0xF100002C		---	[0 to 31]	Reserved
0xF1000030		OrderIDHigh	[0 to 31]	8 Byte ASCII Order ID
0xF1000034		OrderIDLow	[0 to 31]	

Table 127: Advanced register: Extended version information

The micro controller version and FPGA firmware version numbers are bcd-coded, which means that firmware version 0.85 is read as 0x0085 and version 1.10 is read as 0x0110.

The newly added **VERSION_INFOx_EX** registers contain extended bcd-coded version information formatted as *special.major.minor.patch*.

So reading the value **0x00223344** is decoded as:

- Special:0(decimal)
- Major:22(decimal)
- Minor:33(decimal)
- Patch:44(decimal)

This is decoded to the human readable version **22.33.44** (leading zeros are omitted).

Note If a camera returns the register set to all zero, that particular camera does not support the extended version information.



The FPGA type ID (= camera type ID) identifies the camera type with the help of the following list (BL = board level):

ID: S/N 285884416 to 301989887	ID: S/N 319438848 to 335544319	Camera type
401	601	Stingray F-033B (BL)
402	602	Stingray F-033C (BL)
403	603	---
404	604	---
405	605	Stingray F-046B (BL)
406	606	Stingray F-046C (BL)
407	607	Stingray F-080B (BL)
408	608	Stingray F-080C (BL)
409	609	Stingray F-125B (BL)
410	610	Stingray F-125C (BL)
413	613	Stingray F-145B (BL)
414	614	Stingray F-145C (BL)
415	615	Stingray F-146B (BL)
416	616	Stingray F-146C (BL)
417	617	Stingray F-201B (BL)
418	618	Stingray F-201C (BL)
419	619	---
420	620	---
423	623	Stingray F-504B (BL)
424	624	Stingray F-504C (BL)

Table 128: Camera type ID list

Advanced feature inquiry

This register indicates with a named bit if a feature is present or not. If a feature is marked as not present the associated register space might not be available and read/write errors may occur.

Note Ignore unnamed bits in the following table: these bits might be set or not.



Register	Name	Field	Bit	Description
0xF100040	ADV_INQ_1	MaxResolution	[0]	
		TimeBase	[1]	
		ExtdShutter	[2]	
		TestImage	[3]	
		FrameInfo	[4]	
		Sequences	[5]	
		VersionInfo	[6]	
		---	[7]	Reserved
		Look-up tables	[8]	
		Shading	[9]	
		DeferredTrans	[10]	
		HDR mode	[11]	
		---	[12]	Reserved
		---	[13]	Reserved
		TriggerDelay	[14]	
		Mirror image	[15]	
		Soft Reset	[16]	
		High SNR	[17]	
		Color correction	[18]	
		---	[19 to 20]	Reserved
		User Sets	[21]	
---	[22 to 29]	Reserved		
Paramlist_Info	[30]			
GP_Buffer	[31]			

Table 129: Advanced register: Advanced feature inquiry

Register	Name	Field	Bit	Description
0xF1000044	ADV_INQ_2	Input_1	[0]	
		Input_2	[1]	
		---	[2 to 7]	Reserved
		Output_1	[8]	
		Output_2	[9]	
		Output_3	[10]	
		Output_4	[11]	
		---	[12 to 15]	Reserved
		IntEnaDelay	[16]	
		---	[17 to 23]	Reserved
		Output 1 PWM	[24]	Stingray housing and board level cameras
		Output 2 PWM	[25]	
		Output 3 PWM	[26]	
		Output 4 PWM	[27]	
---	[28 to 31]	Reserved		
0xF1000048	ADV_INQ_3	Camera Status	[0]	
		Max IsoSize	[1]	
		Paramupd_Timing	[2]	
		F7 mode mapping	[3]	
		Auto Shutter	[4]	
		Auto Gain	[5]	
		Auto FNC AOI	[6]	
		---	[7 to 14]	Reserved
		Permanent Data Storage	[15]	
---	[16 to 31]			
0xF100004C	ADV_INQ_4	---	[0]	
		---	[1]	
		---	[2]	
		---	[18 to 31]	Reserved

Table 129: Advanced register: Advanced feature inquiry (continued)

Camera status

This register allows to determine the current status of the camera. The most important flag is the **Idle** flag.

If the **Idle** flag is set, the camera does not capture and send any images, though images might be present in the image FIFO.

The **ExSyncArmed** flag indicates that the camera is set up for external triggering. Even if the camera is waiting for an external trigger event the **Idle** flag might get set.

Other bits in this register might be set or toggled: just ignore these bits.

Note



- Excessive polling of this register may slow down the operation of the camera. Therefore, the time between two polls of the status register should not be less than 5 milliseconds. If the time between two read accesses is lower than 5 milliseconds, the response will be delayed.
- Depending on shutter and isochronous settings the status flags might be set for a very short time. In that case, the status flags will not be recognized by your application.

Register	Name	Field	Bit	Description
0xF1000100	CAMERA_STATUS	Presence_Inq	[0]	Indicates presence of this feature (read only)
		---	[1 to 23]	Reserved
		ID	[24 to 31]	Implementation ID = 0x01
0xF1000104		---	[0 to 14]	Reserved
		ExSyncArmed	[15]	External trigger enabled
		---	[16 to 27]	Reserved
		ISO	[28]	Isochronous transmission
		---	[29 to 30]	Reserved
		Idle	[31]	Camera idle

Table 130: Advanced register: Camera status

Maximum resolution

This register indicates the highest resolution for the sensor and is read-only.

Note This register normally outputs the MAX_IMAGE_SIZE_INQ Format_7 Mode_0 value.



This is the value given in the specifications tables under Picture size (maximum) in chapter [Specifications](#) on page 59.

Register	Name	Field	Bit	Description
0xF1000200	MAX_RESOLUTION	MaxWidth	[0 to 15]	Sensor width (read only)
		MaxHeight	[16 to 31]	Sensor height (read only)

Table 131: Advanced register: Maximum resolution inquiry

Time base

Corresponding to IIDC, exposure time is set via a 12-bit value in the corresponding register (SHUTTER_INQ [51Ch] and SHUTTER [81Ch]).

This means that you can enter a value in the range of 1 to 4095.

Stingray cameras use a time base that is multiplied by the shutter register value. This multiplier is configured as the time base via the TIMEBASE register.

Register	Name	Field	Bit	Description
0xF1000208	TIMEBASE	Presence_Inq	[0]	Indicates presence of this feature (read only)
		---	[1 to 7]	Reserved
		ExpOffset	[8 to 19]	Exposure offset in μ s
		---	[20 to 27]	Reserved
		Timebase_ID	[28 to 31]	See Table 133 on page 294.

Table 132: Advanced register: Time base

The time base IDs 0 to 9 are in bit [28] to [31]. See [Table 133](#) on page 294. Refer to the following table for code.

Default time base is 20 μ s: This means that the integration time can be changed in 20 μ s increments with the shutter control.

Note Time base can only be changed when the camera is in idle state and becomes active only after setting the shutter value.



The **ExpOffset** field specifies the camera specific exposure time offset in μs . This time should be equivalent to [Table 67](#) on page 195 and must be added to the exposure time to compute the real exposure time, set by any shutter register.

The **ExpOffset** field might be zero for some cameras: this has to be assumed as an unknown exposure time offset (according to former software versions).

ID	Time base in μs	
0	1	
1	2	
2	5	
3	10	
4	20	Default value
5	50	
6	100	
7	200	
8	500	
9	1000	

Table 133: Time base ID

Note The ABSOLUTE VALUE CSR register, introduced in IIDC V1.3, is not implemented.



Extended shutter

The exposure time for long-term integration of up to 67 s can be entered with μ s precision via the EXTENDED_SHUTTER register.

Register	Name	Field	Bit	Description
0xF100020C	EXTD_SHUTTER	Presence_Inq	[0]	Indicates presence of this feature (read only)
		---	[1 to 5]	Reserved
		ExpTime	[6 to 31]	Exposure time in μ s

Table 134: Advanced register: Extended shutter

The minimum allowed exposure time depends on the camera model. To determine this value write **1** to the **ExpTime** field and read back the minimum allowed exposure time.

The longest exposure time, 3FFFFFFh, corresponds to 67.11 s.

Note



- Exposure times entered via the 81Ch register are mirrored in the extended register, but not vice versa.
- Changes in this register have immediate effect, even when camera is transmitting.
- Extended shutter becomes inactive after writing to a format / mode / frame rate register.
- Extended shutter setting will thus be overwritten by the normal time base/shutter setting after Stop/Start of FireView or FireDemo.

Permanent Data Storage

Stingray cameras with S/N 319438848 to 335544319 offer the Permanent Data Storage (PDS), using the non-volatile memory (Flash) to permanently store data on the camera, such as machine settings, text files, color correction data, or compressed images.

Note



Stingray cameras with S/N 285884416 to 301989887 do not have this feature.

See chapter [Specifications](#) on page 59 for your Stingray model.

Register	Name	Field	Bit	Description
0xF1000B00	PDS_MEM_CTRL	Presence_Inq	[0]	Indicates presence of this feature (read only)
		---	[1 to 4]	Reserved
		EnableMemWR	[5]	Enable write access
		EnableMemRD	[6]	Enable read access
		EraseMem	[7]	Erase data storage
		AddrOffset	[8 to 31]	In bytes
0xF1000B04	PDS_INFO	Presence_Inq	[0]	Indicates presence of this feature (read only)
		---	[1 to 7]	Reserved
		MaxSize	[8 to 31]	Maximum data storage size (in bytes)

Table 135: Advanced register: Permanent Data Storage (PDS)

Note



The memory chip inside the Stingray camera supports typically up to 100,000 erase cycles. This is caused by material aging. Please consider this when using PDS.

Note



Accessing the data storage inside the camera is done through the Gpdata_Buffer. Data must be written/read in multiple steps, because the size of the Gpdata_Buffer is typically smaller than the complete data to be read/written.

Reading from the data storage

To read from the data storage:

1. Query the limits and ranges by reading PDS_INFO and Gpdata_Info.
2. Set **EnableMemRD** to true (1).
3. Set **AddrOffset** to 0.
4. Read n data bytes from PDATA_BUFFER (n might be lower than the size of the Gpdata_Buffer; AddrOffset is automatically adjusted inside the camera).
5. Repeat step 4 until all data is read from the camera.
6. Set **EnableMemRD** to false.

Writing to an empty data storage

Caution



To avoid overwriting, should data be appended in a future session, record the **AddrOffset** value at the end of write session.

For appending data to the data storage, see next: chapter [Append data to the data storage](#) on page 297.

To write to the data storage:

1. Query the limits and ranges by reading PDS_INFO and GPDATA_INFO.
2. Set **EnableMemWR** to true (1).
3. Set **AddrOffset** to 0.
4. Write n data bytes to GPDATA_BUFFER (n might be lower than the size of the GPDATA_BUFFER; AddrOffset is automatically adjusted inside the camera).
This may take up to 400 ms
5. Repeat step 4 until all data is read from the camera.
6. Set **EnableMemWR** to false.

Append data to the data storage

In this case the data storage is not empty.

Note



To append data to the data storage, set **AddrOffset** = [recorded value] + 1.

[Recorded value] is the value noted for the last write session. See chapter [Writing to an empty data storage](#) on page 297.

To continue writing to the data storage:

1. Query the limits and ranges by reading PDS_INFO and GPDATA_INFO.
2. Set **EnableMemWR** to true (1).
3. Set **AddrOffset** to [recorded value] + 1 (see note above).
4. Write n data bytes to GPDATA_BUFFER (n might be lower than the size of the GPDATA_BUFFER; AddrOffset is automatically adjusted inside the camera).
This may take up to 400 ms
5. Repeat step 4 until all data is read from the camera.
6. Set **EnableMemWR** to false.

Erasing data on the camera

Note Erasing the data storage may take up to 30 s.



To erase the data storage:

1. Set **EraseMem** to true (1).
EraseMem is automatically reset to false (0). This cannot be polled.

Test images

Bit [8] to [14] indicate which test images are saved. Setting bit [28] to [31] activates or deactivates existing test images.

By activating any test image the following auto features are automatically disabled:

- Auto gain
- Auto shutter
- Auto white balance

Register	Name	Field	Bit	Description
0xF1000210	TEST_IMAGE	Presence_Inq	[0]	Indicates presence of this feature (read only)
		---	[1 to 7]	Reserved
		Image_Inq_1	[8]	Presence of test image 1 0: N/A 1: Available
		Image_Inq_2	[9]	Presence of test image 2 0: N/A 1: Available
		Image_Inq_3	[10]	Presence of test image 3 0: N/A 1: Available
		Image_Inq_4	[11]	Presence of test image 4 0: N/A 1: Available
		Image_Inq_5	[12]	Presence of test image 5 0: N/A 1: Available
		Image_Inq_6	[13]	Presence of test image 6 0: N/A 1: Available
		Image_Inq_7	[14]	Presence of test image 7 0: N/A 1: Available
		---	[15 to 27]	Reserved
		TestImage_ID	[28 to 31]	0: No test image active 1: Image 1 active 2: Image 2 active ...

Table 136: Advanced register: Test images

Look-up tables (LUT)

The LUT to be used in the camera are chosen via the **LutNo** field. The LUTs are activated via the **LUT_CTRL** register.

The LUT_INFO register indicates how many LUTs the camera can store and shows the maximum size of the individual LUTs.

The possible values for **LutNo** are 0 to n-1; whereas, n can be determined by reading the field **NumOfLuts** of the LUT_INFO register.

Register	Name	Field	Bit	Description
0xF1000240	LUT_CTRL	Presence_Inq	[0]	Indicates presence of this feature (read only)
		---	[1 to 5]	Reserved
		ON_OFF	[6]	Enable/disable this feature
		---	[7 to 25]	Reserved
		LutNo	[26 to 31]	Use LUTwith LutNo number
0xF1000244	LUT_MEM_CTRL	Presence_Inq	[0]	Indicates presence of this feature (read only)
		---	[1 to 4]	Reserved
		EnableMemWR	[5]	Enable write access
		---	[6 to 7]	Reserved
		AccessLutNo	[8 to 15]	
		AddrOffset	[16 to 31]	byte
0xF1000248	LUT_INFO	Presence_Inq	[0]	Indicates presence of this feature (read only)
		---	[1 to 2]	Reserved
		BitsPerValue	[3 to 7]	Bits used per table item
		NumOfLuts	[8 to 15]	Maximum number of look-up tables
		MaxLutSize	[16 to 31]	Maximum LUTsize (bytes)

Table 137: Advanced register: LUT

Note

The **BitsPerValue** field indicates how many bits are read from the LUT for any gray-value read from the sensor. To determine the number of bytes occupied for each gray-value round-up the **BitsPerValue** field to the next byte boundary.

Examples:

- BitsPerValue = 8 → 1 byte per gray-value
- BitsPerValue = 14 → 2 byte per gray-value

Divide **MaxLutSize** by the number of bytes per gray-value in order to get the number of LUT entries (gray levels): that is 2^n with n =number of bits read from sensor.

Note

Stingray cameras have the gamma feature implemented via a built-in LUT. Therefore, gamma and LUT cannot be used at the same time. As a solution, a gamma LUT may be combined with other LUTs.

Note

When using the LUT feature and the gamma feature, pay attention to the following:

- Gamma ON → LUT is switched ON
- Gamma OFF → LUT is switched OFF
- LUT OFF → Gamma is switched OFF
- LUT ON → Gamma is switched OFF

Loading a LUT into the camera

Loading a LUT into the camera is done through the GPDATA_BUFFER. The size of the GPDATA_BUFFER is smaller than a complete LUT; therefore the data must be written in multiple steps.

To load a lookup table into the camera:

1. Query the limits and ranges by reading LUT_INFO and GPDATA_INFO.
2. Set **EnableMemWR** to true (1).
3. Set **AccessLutNo** to the desired number.
4. Set **AddrOffset** to 0.
5. Write n lookup table data bytes to GPDATA_BUFFER (n might be lower than the size of the GPDATA_BUFFER; AddrOffset is automatically adjusted inside the camera).
6. Repeat step 5 until all data is written into the camera.
7. Set **EnableMemWR** to false (0).

Shading correction

Owing to technical circumstances, the interaction of recorded objects with one another, optical effects, and lighting non-homogeneities may occur in the images.

Normally, these effects are not desired. They should be eliminated as far as possible in subsequent image editing. The camera has automatic shading correction to do this.

Provided a shading image is present in the camera, the **on/off** bit can be used to enable shading correction.

The **on/off** and **ShowImage** bits must be set for saved shading images to be displayed.

Note



- Ensure that the shading image is saved at the highest resolution of the camera. If a lower resolution is chosen and **ShowImage** is set to **true**, the image will not be displayed correctly.
- The shading image is computed using the current video settings. On fixed video modes the selected frame rate also affects the computation time.

Register	Name	Field	Bit	Description
0xF1000250	SHDG_CTRL	Presence_Inq	[0]	Indicates presence of this feature (read only)
		BuildError	[1]	Could not built shading image
		---	[2 to 3]	Reserved
		ShowImage	[4]	Show shading data as image
		BuildImage	[5]	Build a new shading image
		ON_OFF	[6]	Shading on/off
		Busy	[7]	Build in progress
		---	[8 to 15]	Reserved
		MemChannelError	[16 to 19]	Indicates memory channel error. See Table 138 on page 302
		MemoryChannel	[20 to 23]	Set memory channel number for save and load operations
GrabCount	[24 to 31]	Number of images		

Table 138: Advanced register: Shading

Register	Name	Field	Bit	Description
0xF1000254	SHDG_MEM_CTRL	Presence_Inq	[0]	Indicates presence of this feature (read only)
		---	[1 to 4]	Reserved
		EnableMemWR	[5]	Enable write access
		EnableMemRD	[6]	Enable read access
		---	[7]	Reserved
		AddrOffset	[8 to 31]	In bytes
0xF1000258	SHDG_INFO	Presence_Inq	[0]	Indicates presence of this feature (read only)
		---	[1 to 3]	Reserved
		MaxMemChannel	[4 to 7]	Maximum number of available memory channels to store shading images
		MaxImageSize	[8 to 31]	Maximum shading image size (in bytes)

Table 138: Advanced register: Shading (continued)

Reading or writing shading image from/into the camera

Accessing the shading image inside the camera is done through the GPDATA_BUFFER. Data must be written in multiple steps, because the size of the GPDATA_BUFFER is smaller than a whole shading image.

To read or write a shading image:

1. Query the limits and ranges by reading SHDG_INFO and GPDATA_INFO.
2. Set **EnableMemWR** or **EnableMemRD** to true (1).
3. Set **AddrOffset** to 0.
4. Write n shading data bytes to GPDATA_BUFFER (n might be lower than the size of the GPDATA_BUFFER; AddrOffset is automatically adjusted inside the camera).
5. Repeat step 4 until all data is written into the camera.
6. Set **EnableMemWR** and **EnableMemRD** to false.

Automatic generation of a shading image

Shading image data may also be generated by the camera. To use this feature make sure all settings affecting an image are set properly. The camera uses the current active resolution to generate the shading image.

To generate a shading image:

1. Set **GrabCount** to the number of the images to be averaged before the correction factors are calculated.
2. Set **BuildImage** to true.
3. Poll the SHDG_CTRL register until the **Busy** and **BuildImage** flags are reset automatically.

The maximum value of GrabCount depends on the camera type and the number of available image buffers. GrabCount is automatically adjusted to a power of two.

SHDG_CTRL register should not be polled too often, while automatic generation is in progress. Each poll delays the process of generating the shading image. An optimal poll interval time is 500 ms.

Memory channel error codes

ID	Error description
0x00	No error
0x01	Memory detection error
0x02	Memory size error
0x03	Memory erase error
0x04	Memory write error
0x05	Memory header write error
0x0F	Memory channel out of range

Table 139: Memory channel error description

Deferred image transport

Using this register, the sequence of recording and the transfer of the images can be paused. Setting **HoldImg** prevents transfer of the image. The images are stored in **ImageFIFO**.

The images indicated by **NumOfImages** are sent by setting the **SendImage** bit. When **FastCapture** is set (in Format_7 only), images are recorded at the highest possible frame rate.

Register	Name	Field	Bit	Description
0xF1000260	DEFERRED_TRANS	Presence_Inq	[0]	Indicates presence of this feature (read only)
		---	[1 to 4]	Reserved
		SendImage	[5]	Send NumOfImages now (auto reset)
		HoldImg	[6]	Enable/Disable deferred transport mode
		FastCapture	[7]	Enable/disable fast capture mode
		---	[8 to 15]	Reserved
		FiFoSize	[16 to 23]	Size of FIFO in number of images (read only)
		NumOfImages	[24 to 31]	Write: Number of images to send Read: Number of images in buffer

Table 140: Advanced register: Deferred image transport

Frame information

This register is used to double-check the number of images received by the host computer against the number of images that were transmitted by the camera. The camera increments this counter with every FrameValid signal. This is a mirror of the frame counter information found at 0xF1000610.

Register	Name	Field	Bit	Description
0xF1000270	FRAMEINFO	Presence_Inq	[0]	Indicates presence of this feature (read only)
		ResetFrameCnt	[1]	Reset frame counter
		---	[2 to 31]	Reserved
0xF1000274	FRAMECOUNTER	FrameCounter	[0 to 31]	Number of captured frames since last reset

Table 141: Advanced register: Frame information

The **FrameCounter** is incremented when an image is read out of the sensor.

The **FrameCounter** does not indicate whether an image was sent over the IEEE 1394 bus or not.

Defect pixel correction

Definition. The defect pixel correction mode allows to correct an image with defect pixels. Threshold defines the defect pixels in an image. Defect pixel correction is done in the FPGA. Defect pixel data can be stored inside the camera's EEPROM.

DPC = defect pixel correction

WR = write

RD = read

MEM, Mem = memory

Note



- Defect pixel correction is always done in **Format_7 Mode_0**.
- When using defect pixel correction with **binning** and **sub-sampling**: first switch to binning/sub-sampling modus and then apply defect pixel correction.

Register	Name	Field	Bit	Description
0xF1000298	DPC_CTRL	Presence_Inq	[0]	Indicates presence of this feature (read only)
		BuildError	[1]	Build defect pixel data that reports an error, e.g. more than 256 defect pixels, see DPDataSize
		---	[2 to 4]	Reserved
		BuildDPData	[5]	Build defect pixel data now
		ON_OFF	[6]	Enable/disable this feature
		Busy	[7]	Build defect pixel data in progress
		MemSave	[8]	Save defect pixel data to storage
		MemLoad	[9]	Load defect pixel data from storage
		ZeroDPData	[10]	Zero defect pixel data
		---	[11 to 17]	Reserved
		Mean	[18 to 24]	Calculated mean value (7 bit)
		Threshold	[25 to 31]	Threshold for defect pixel correction

Table 142: Advanced register: Defect pixel correction

Register	Name	Field	Bit	Description
0xF100029C	DPC_MEM	Presence_Inq	[0]	Indicates presence of this feature (read only)
		---	[1]	Reserved
		EnaMemWR	[2]	Enable write access from host to RAM
		EnaMemRD	[3]	Enable read access from RAM to host
		DPDataSize	[4 to 17]	Size of defect pixel data to read from RAM to host. A maximum of 256 defect pixels can be stored. In case of more than 256 defect pixels, DPDataSize is set to 257 and BuildError flag is set to 1. Defect pixel correction data is done with first 256 defect pixels only.
		AddrOffset	[18 to 31]	Address offset to selected defect pixel data
0xF10002A0	DPC_INFO	Presence_Inq	[0]	Indicates presence of this feature (read only)
		---	[1 to 3]	Reserved
		MinThreshold	[4 to 10]	Minimum value for threshold
		MaxThreshold	[11 to 17]	Maximum value for threshold
		MaxSize	[18 to 31]	Maximum size of defect pixel data

Table 142: Advanced register: Defect pixel correction (continued)

Input/output pin control

Note



- See chapter [Input/output pin control](#) on page 108
- See chapter [IO_INP_CTRL 1-2](#) on page 108
- See chapter [IO_OUTP_CTRL 1-4](#) on page 112
- See chapter [Output modes](#) on page 114

Delayed Integration Enable (IntEna)

A delay time between initiating exposure on the sensor and the activation edge of the **IntEna** signal can be set using this register. The **on/off** flag activates/deactivates integration delay. The time can be set in μs in **DelayTime**.

Note



- Only one edge is delayed.
- If **IntEna_Out** is used to control an exposure, it is possible to have a variation in brightness or to precisely time a flash.

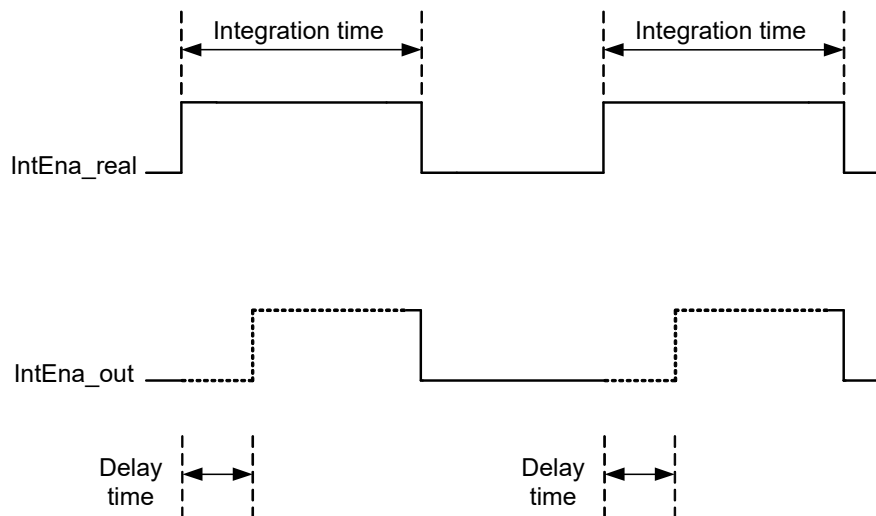

Figure 107: Delayed integration timing

Register	Name	Field	Bit	Description
0xF1000340	IO_INTENA_DELAY	Presence_Inq	[0]	Indicates presence of this feature (read only)
		---	[1 to 5]	Reserved
		ON_OFF	[6]	Enable/disable integration enable delay
		---	[7 to 11]	Reserved
		DELAY_TIME	[12 to 31]	Delay time in μ s

Table 143: Advanced register: Delayed Integration Enable (IntEna)

Auto shutter control

The table below illustrates the advanced register for **auto shutter control**. The purpose of this register is to limit the range within which auto shutter operates.

Register	Name	Field	Bit	Description
0xF1000360	AUTOSHUTTER_CTRL	Presence_Inq	[0]	Indicates presence of this feature (read only)
		---	[1 to 31]	Reserved
0xF1000364	AUTOSHUTTER_LO	---	[0 to 5]	Reserved
		MinValue	[6 to 31]	Minimum auto shutter value lowest possible value: 10 μ s
0xF1000368	AUTOSHUTTER_HI	---	[0 to 5]	Reserved
		MaxValue	[6 to 31]	Maximum auto shutter value

Table 144: Advanced register: Auto shutter control

Note



- Values can only be changed within the limits of shutter CSR.
- Changes in auto exposure register only have an effect when auto shutter is enabled.
- Auto exposure limits are: 50 to 205 (**SmartView** → **Ctrl1 tab: Target grey level**)

When both **auto shutter** and **auto gain** are enabled, priority is given to increasing shutter when brightness decreases. This is done to achieve the best image quality with lowest noise.

For increasing brightness, priority is given to lowering gain first for the same purpose.

MinValue and **MaxValue** limits the range the auto shutter feature is allowed to use for the regulation process. Both values are initialized with the minimum and maximum value defined in the standard SHUTTER_INQ register (multiplied by the current active timebase).

If you change the **MinValue** and/or **MaxValue** and the new range exceeds the range defined by the SHUTTER_INQ register, the standard SHUTTER register will not show correct shutter values. In this case, read the EXTENDED_SHUTTER register for the current active shutter time.

Changing the auto shutter range might not affect the regulation, if the regulation is in a stable condition and no other condition affecting the image brightness is changed.

If both **auto gain** and **auto shutter** are enabled and if the shutter is at its upper boundary and gain regulation is in progress, increasing the upper auto shutter boundary has no effect on auto gain/shutter regulation as long as auto gain regulation is active.

Note

As with the Extended Shutter the value of **MinValue** and **MaxValue** must not be set to a lower value than the minimum shutter time.

Auto gain control

The table below illustrates the advanced register for **auto gain control**.

Register	Name	Field	Bit	Description
0xF1000370	AUTOGAIN_CTRL	Presence_Inq	[0]	Indicates presence of this feature (read only)
		---	[1 to 3]	Reserved
		MaxValue	[4 to 15]	Maximum auto gain value
		---	[16 to 19]	Reserved
		MinValue	[20 to 31]	Minimum auto gain value

Table 145: Advanced register: Auto gain control

MinValue and **MaxValue** limits the range the auto gain feature is allowed to use for the regulation process. Both values are initialized with the minimum and maximum value defined in the standard GAIN_INQ register.

Changing the **auto gain range** might not affect the regulation, if the regulation is in a stable condition and no other condition affecting the image brightness is changed.

If both **auto gain** and **auto shutter** are enabled and if the gain is at its lower boundary and shutter regulation is in progress, decreasing the lower auto gain boundary has no effect on auto gain/shutter regulation as long as auto shutter regulation is active.

Both values can only be changed within the range defined by the standard GAIN_INQ register.

Autofunction AOI

The table below illustrates the advanced register for **autofunction AOI**.

Register	Name	Field	Bit	Description
0xF1000390	AUTOFNC_AOI	Presence_Inq	[0]	Indicates presence of this feature (read only)
		---	[1 to 3]	Reserved
		ShowWorkArea	[4]	Show work area
		---	[5]	Reserved
		ON_OFF	[6]	Enable/disable AOI (see note above)
		---	[7]	Reserved
		YUNITS	[8 to 19]	Y units of work area/pos. beginning with 0 (read only)
0xF1000394	AF_AREA_POSITION	Left	[0 to 15]	Work area position (left coordinate)
		Top	[16 to 31]	Work area position (top coordinate)
0xF1000398	AF_AREA_SIZE	Width	[0 to 15]	Width of work area size
		Height	[16 to 31]	Height of work area size

Table 146: Advanced register: Autofunction AOI

The possible increment of the work area position and size is defined by the YUNITS and XUNITS fields. The camera automatically adjusts your settings to permitted values.

Note



If the adjustment fails and the work area size and/or work area position becomes invalid, then this feature is automatically switched off

Read back the ON_OFF flag, if this feature does not work as expected.

Color correction

To switch off color correction in YUV mode: see bit [6]

Register	Name	Field	Bit	Description
0xF10003A0	COLOR_CORR	Presence_Inq	[0]	Indicates presence of this feature (read only)
		---	[1 to 5]	Reserved
		ON_OFF	[6]	Color correction on/off default: on Write: 02000000h to switch color correction OFF Write: 00000000h to switch color correction ON
		Reset	[7]	Reset to defaults
		---	[8 to 31]	Reserved
0xF10003A4	COLOR_CORR_COEFFIC11 = Crr		[0 to 31]	A number of 1000 equals a color correction coefficient of 1. Color correction values range -1000 to +2000 and are signed 32 bit . In order for white balance to work properly ensure that the row sum equals to 1000. The maximum row sum is limited to 2000.
0xF10003A8	COLOR_CORR_COEFFIC12 = Cgr		[0 to 31]	
0xF10003AC	COLOR_CORR_COEFFIC13 = Cbr		[0 to 31]	
0xF10003B0	COLOR_CORR_COEFFIC21 = Crg		[0 to 31]	
0xF10003B4	COLOR_CORR_COEFFIC22 = Cgg		[0 to 31]	
0xF10003B8	COLOR_CORR_COEFFIC23 = Cbg		[0 to 31]	
0xF10003BC	COLOR_CORR_COEFFIC31 = Crb		[0 to 31]	
0xF10003C0	COLOR_CORR_COEFFIC32 = Cgb		[0 to 31]	
0xF10003C4	COLOR_CORR_COEFFIC33 = Cbb		[0 to 31]	
0xF10003A4 to 0xF10003FC				

Table 147: Advanced register: Color correction

For an explanation of the color correction matrix and for further information read chapter [Color correction](#) on page 179.

Trigger delay

Register	Name	Field	Bit	Description
0xF1000400	TRIGGER_DELAY	Presence_Inq	[0]	Indicates presence of this feature (read only)
		---	[1 to 5]	Reserved
		ON_OFF	[6]	Trigger delay on/off
		---	[7 to 10]	Reserved
		DelayTime	[11 to 31]	Delay time in μ s

Table 148: Advanced register: Trigger delay

The advanced register allows start of the integration to be delayed via **DelayTime** by maximum 2^{21} μ s, which is maximum 2.1 s after a trigger edge was detected.

Note _____ Trigger delay works with external trigger modes only.



Mirror image

The table below illustrates the advanced register for **Mirror image**.

Register	Name	Field	Bit	Description
0xF1000410	MIRROR_IMAGE	Presence_Inq	[0]	Indicates presence of this feature (read only)
		---	[1 to 5]	Reserved
		ON_OFF	[6]	Mirror image on/off 1: on 0: off Default: off
		---	[7 to 31]	Reserved

Table 149: Advanced register: Mirror image

Soft reset

Register	Name	Field	Bit	Description
0xF1000510	SOFT_RESET	Presence_Inq	[0]	Indicates presence of this feature (read only)
		---	[1 to 5]	Reserved
		Reset	[6]	Initiate reset
		---	[7 to 19]	Reserved
		Delay	[20 to 31]	Delay reset in 10 ms steps

Table 150: Advanced register: Soft reset

The **soft reset** feature is similar to the INITIALIZE register, with the following differences:

- 1 or more bus resets will occur
- The FPGA will be rebooted

The reset can be delayed by setting the **Delay** to a value unequal to 0.

The delay is defined in 10 ms steps.

Note

When SOFT_RESET has been defined, the camera will respond to further read or write requests but will not process them.



High SNR mode (High Signal Noise Ratio)

With **High SNR** mode enabled the camera internally grabs **GrabCount** images and outputs a single averaged image.

Register	Name	Field	Bit	Description
0xF100520	HIGH_SNR	Presence_Inq	[0]	Indicates presence of this feature (read only)
		---	[1 to 5]	Reserved
		ON_OFF	[6]	High SNR mode on/off High SNR mode on requires a minimum GrabCount value of 2 . Set grab count and activation of HighSNR in one single write access .
		---	[7 to 22]	Reserved
		GrabCount	[23 to 31]	Enter number of images Permissible values are: 2, 4, 8, 16, 32, 64, 128, 256 If you enter a non-expected value, the firmware will round down to the first permitted value. Example: Enter 255, firmware will write 128 to the register.

Table 151: Advanced register: High Signal Noise Ratio (HSNR)

Note



- The camera must be idle to toggle this feature on/of Idle means: no image acquisition, no trigger.
- Set grab count and activation of HighSNR in **one single write access**.

Note



- Writing to the HIGH_SNR register while capture is active will accept the new value, but it will not become active. Subsequently stopping and starting acquisition will not change this, either.
- Writing the HIGH_SNR register is **only effective** if done while the camera is not actively acquiring.

Maximum ISO packet size

Use this feature to increase the MaxBytePerPacket value of Format_7 modes. This overrides the maximum allowed isochronous packet size specified by IIDC V1.31.

Register	Name	Field	Bit	Description
0xF1000560	ISOSIZE_S400	Presence_Inq	[0]	Indicates presence of this feature (read only)
		---	[1 to 5]	Reserved
		ON_OFF	[6]	Enable/Disable S400 settings
		Set2Max	[7]	Set to maximum supported packet size
		---	[8 to 15]	Reserved
		MaxIsoSize	[16 to 31]	Maximum ISO packet size for S400
0xF1000564	ISOSIZE_S800	Presence_Inq	[0]	Indicates presence of this feature (read only)
		---	[1 to 5]	Reserved
		ON_OFF	[6]	Enable/Disable S800 settings
		Set2Max	[7]	Set to maximum supported packet size
		---	[8 to 15]	Reserved
		MaxIsoSize	[16 to 31]	Maximum ISO packet size for S800

Table 152: Advanced register: Maximum ISO packet size

Example For isochronous packets at a speed of S800 the maximum allowed packet size (IIDC V1.31) is 8192 byte. This feature allows you to extend the size of an isochronous packet up to 11,000 byte at S800. Thus, the isochronous bandwidth is increased from 64 MB/s to approximately 84 MB/s. You need either PCI Express or PCI-X (64 bit).

The **Maximum ISO packet size** feature to

- to reduces the asynchronous bandwidth available for controlling cameras by approximately 75%
- to may lead to slower responses on commands
- to is not covered by the IEEE 1394 specification
- to may not work with all available IEEE 1394 host adapters

Note We strongly recommend to use **PCI-X (64 bit)** or **PCI Express** adapter.



Restrictions Note the restrictions in the following table. When using software with an Isochronous Resource Manager (IRM): deactivate it.

Software	Restrictions
FireGrab	Deactivate Isochronous Resource Manager: SetParameter (FGP_USEIRMFORBW, 0)
FireStack/FireClass	No restrictions
SDKs using Microsoft driver (Active FirePackage, Direct FirePackage, to)	n/a
Linux: libdc1394_1.x	No restrictions
Linux: libdc1394_2.x	Deactivate Isochronous Resource Manager: Set DC1394_CAPTURE_FLAGS_BANDWIDTH_ALLOC flag to 0
Third Party Software	Deactivate Isochronous Resource Manager

Table 153: Restrictions for feature: Maximum ISO packet size

Operation The maximum allowed isochronous packet size can be set separately for the ISO speeds S400 and S800. Check the associated **Presence_Inq** flag to see for which ISO speed this feature is available.

Setting the **Set2Max** flag to 1 sets the **MaxIsoSize** field to the maximum supported isochronous packet size. Use this flag to query the maximum supported size (may depend on the camera model).

Enable this feature by setting the **ON_OFF** flag to 1 and the **MaxIsoSize** field to a value greater than the default packet size.

The camera ensures:

- that the value of the **MaxIsoSize** field is a multiple of 4.
- that the value is not lower than the value specified by the IEEE 1394 specification.

The settings are stored in the user sets.

Note  Enabling this feature will not change the **MaxBytePerPacket** value automatically. The camera may not use the new isochronous packet size for the **MaxBytePerPacket** value until a write access to the desired Format_7 mode has been issued.

Quick parameter change timing modes

You can choose between the following update timing modes:

- **Standard Parameter Update Timing** (slightly modified from previous Stingray cameras)
- **Quick Format Change Mode**

Note For a detailed description see chapter [Quick parameter change timing modes](#) on page 165.



Register	Name	Field	Bit	Description
0xF1000570	PARAMUPD_TIMING	Presence_Inq	[0]	Indicates presence of this feature (read only)
		---	[1 to 5]	Reserved
		UpdActive	[6]	Update active see chapter Encapsulated Update (begin/end) on page 167 0: (default); reset to 0 means Encapsulated Update end 1: set to 1 means Encapsulated Update begin
		---	[7 to 23]	Reserved
		UpdTiming	[24 to 31]	Update timing mode If set to 0: Standard Parameter Update Timing is active If set to 2: Quick Format Change Mode is active

Table 154: Advanced register: Update timing modes

Standard Parameter Update Timing

The camera behaves like older firmware versions without this feature. The **UpdActive** flag has no meaning.

Quick Format Change Mode

This mode behaves like **Standard Parameter Update Timing** mode with the following exception:

An already started image transport to the host will not be interrupted, but an already started integration will be interrupted.

To switch on **Quick Format Change Mode** do the following:

1. Set UpdTiming to 2.
2. Set UpdActive to 1.
3. Be aware that all parameter values have to be set within 10 seconds.

Automatic reset of the UpdActive flag

Quick Format Change Mode clears the **UpdActive** flag after all desired parameters have been set. Every time the **PARAMUPD_TIMING** register is written to with the **UpdActive** flag set to 1 a 10 second time-out is started/restarted. If the time-out passes before the **UpdActive** flag is cleared, the **UpdActive** flag is cleared automatically and all parameter changes since setting the **UpdActive** flag to 1 become active automatically.

Parameter-List Update

The parameter list is an array of address/data pairs which can be sent to the camera in a single bus cycle.

Register	Name	Field	Bit	Description
0xF1100000	PARAMLIST_INFO	Presence_Inq	[0]	Indicates presence of this feature (read only)
		---	[1 to 15]	Reserved
		BufferSize	[16 to 31]	Size of parameter list buffer in bytes
0xF1101000 to 0xF1101nnn	PARAMLIST_BUFFER			

Table 155: Advanced register: **Parameter-List Update**: parameter list

Dependant on the parameter update mode the address/data pairs may become active one by one or after the processing of the complete parameter list. A parameter list may look like follows (the description is for your convenience):

Address offset	Data quadlet	Description
0xF0F00608	0xE0000000	Set video format 7
0xF0F00604	0x00000000	Set video mode 0
0xF0F08008	0x00000000	Set image position
0xF0F0800C	0x028001E0	Set image size
0xF0F08044	0x04840484	Set BytePerPacket value
0xF0F0080C	0x80000100	Set shutter to 0x100
0xF0F00820	0x80000080	Set gain to 0x80

Table 156: Example: parameter list

Note



- The PARAMLIST_BUFFER shares the memory with the GPDATA_BUFFER. Therefore, it is not possible to use both features at the same time.
- Not all CSRs or features of a particular camera model can be used with the parameter list feature.

Format_7 mode mapping

With Format_7 mode mapping it is possible to map special binning and sub-sampling modes to F7M1 to F7M7 (see [Table 76](#) on page 164).

Register	Name	Field	Bit	Description
0xF1000580	F7MODE_MAPPING	Presence_Inq	[0]	Indicates presence of this feature (read only)
		---	[1 to 31]	Reserved
0xF1000584	F7MODE_MAP_INQ	F7MODE_00_INQ	[0]	Format_7 Mode_0 presence
		F7MODE_01_INQ	[1]	Format_7 Mode_1 presence
		to	to	to
		F7MODE_31_INQ	[31]	Format_7 Mode_31 presence
0xF1000588	Reserved	---	---	---
0xF100058C	Reserved	---	---	---
0xF1000590	F7MODE_0	Format_ID	[0 to 31]	Format ID (read only)
0xF1000594	F7MODE_1	Format_ID	[0 to 31]	Format ID for Format_7 Mode_1
0xF1000598	F7MODE_2	Format_ID	[0 to 31]	Format ID for Format_7 Mode_2
0xF100059C	F7MODE_3	Format_ID	[0 to 31]	Format ID for Format_7 Mode_3
0xF10005A0	F7MODE_4	Format_ID	[0 to 31]	Format ID for Format_7 Mode_4
0xF10005A4	F7MODE_5	Format_ID	[0 to 31]	Format ID for Format_7 Mode_5
0xF10005A8	F7MODE_6	Format_ID	[0 to 31]	Format ID for Format_7 Mode_6
0xF10005AC	F7MODE_7	Format_ID	[0 to 31]	Format ID for Format_7 Mode_7

Table 157: Advanced register: Format_7 mode mapping

Additional Format_7 modes

Firmware 3.x adds additional Format_7 modes. Now you can add some special Format_7 modes that are not covered by the IIDC standard. These special modes implement **binning** and **sub-sampling**.

To stay as close as possible to the IIDC standard the Format_7 modes can be mapped into the register space of the standard Format_7 modes.

There are visible Format_7 modes and internal Format_7 modes:

- At any time only 8 Format_7 modes can be accessed by a host computer.
- Visible Format_7 modes are numbered from 0 to 7.
- Internal Format_7 modes are numbered from 0 to 27.

Format_7 Mode_0 represents the **mode with the maximum resolution** of the camera: this visible mode cannot be mapped to any other internal mode.

The remaining visible Format_7 Mode_1 to Mode_7 can be mapped to any internal Format_7 mode.

Example

To map the internal Format_7 Mode_19 to the visible Format_7 Mode_1, write the decimal number 19 to the above listed F7MODE_1 register.

Note

For available Format_7 modes see .

Setting the F7MODE_x register to:

- -1 forces the camera to use the factory defined mode
- -2 disables the respective Format_7 mode (no mapping is applied)

After setup of personal Format_7 mode mappings you have to reset the camera. The mapping is performed during the camera startup only.

Low noise binning mode (2 x and 4 x binning)

This register enables/disables **low noise binning mode**.

An average (and not a sum) of the luminance values is calculated within the FPGA.

The image is darker than with the usual binning mode but the signal to noise ratio is better (approximately a factor of $\sqrt{2}$).

Offset	Name	Field	Bit	Description
0xF10005B0	LOW_NOISE_BINNING	Presence_Inq	[0]	Indicates presence of this feature (read only)
		---	[1 to 5]	Reserved
		ON_OFF	[6]	Low noise binning mode on/off
		---	[7 to 31]	Reserved

Table 158: Advanced register: Low noise binning mode

Secure image signature (SIS)

Definition Secure image signature (SIS) is the synonym for data, that is inserted into an image to improve or check image integrity.

All Stingray models can, for example, insert into a selectable line position within the image:

- **Cycle time** (IEEE 1394 bus cycle time at the beginning of integration)
- **Frame counter** (frames read out of the sensor)
- **Trigger counter** (external trigger seen only)

Frame counter and **trigger counter** are available as advanced registers to be read out directly.

Advanced register: SIS

The **SIS** feature is controlled by the following advanced feature register:

Note This register is **different** to the Marlin **time stamp** (600) register!



Register	Name	Field	Bit	Description
0xF1000630	SIS	Presence_Inq	[0]	Indicates presence of this feature (read only)
		---	[1 to 5]	Reserved
		ON_OFF	[6]	SIS mode on/off
		---	[7 to 15]	Reserved
		LineNo	[16 to 31]	SIS data position inside an image
0xF1000634		UserValue	[0 to 31]	User provided value for sequence mode to be placed into the SIS area of an image

Table 159: Advanced register: secure image signature (SIS)

Enabling this feature, SIS data will be inserted into any captured image. The size of SIS data depends on the selected SIS format.

The **LineNo** field indicates at which line the SIS data will be inserted.

SIS: Position in the image

Enter a

- **positive value** from 0 to HeightOfImage to specify a position relative to the top of the image. LinePos=0 specifies the very first image line.
- **negative value** from -1 to -HeightOfImage to specify a position relative to the bottom of the image. LinePos=-1 specifies the very last image line.

SIS **UserValue** can be written into the camera's image. In sequence mode for every sequence entry an own SIS **UserValue** can be written.

Note



SIS outside the visible image area:

For certain Format_7 modes the image frame transported may contain padding (filling) data at the end of the transported frame. Setting LinePos = HeightOfImage places SIS in this padding data area, outside the visible area (invisible SIS).

If the transported image frame does not contain any padding data the camera will not relocate the SIS to the visible area automatically (no SIS).

Take in mind that the accuracy of SIS might be affected by asynchronous traffic – mainly if image settings are changed.

Note



- The IEEE 1394 **cycle time** will be inserted into the **very first 4 bytes of a line**.
- **Cycle time** is a structure and not really a counter in its first meaning.
- **Cycle time** has the three components:
 - Cycle offset
 - Cycles
 - Seconds
- **Cycle time** is a nested counter: see table below.

Feature	Cycle offset	Cycles	Seconds
Bit depth	12 bit	13 bit	7 bit
Range	0 to 3071 cycle offsets	0 to 7999 cycles	0 to 127 seconds
Frequency	24.576 MHz ⇔ 40.69 ns	8000 Hz ⇔ 125 µs	1 Hz ⇔ 1 s

Table 160: Structure of cycle time

Examples: cycle time

The following three examples allow you:

- A: to access cycle time either via UniAPI or via byte array
- B: to extract cycle offset, cycles and seconds
- C: to combine cycle offset/cycles/seconds to a valid time

Example	Example code and description
A	<p>nCycleTime can be accessed:</p> <ul style="list-style-type: none"> using the SIS structure S_SIS_DATA of the UniAPI: <code>nCycleTime = * (UINT32 *) &Sis[0];</code> using byte array: If you can access the image buffer as an array of bytes you can assemble the first four bytes of the image buffer (assuming that the SIS is in the first row): <code>nCycleTime = data[0] + (data[1]<<8) + (data[2]<<16) + (data[3]<<24);</code>
B	<p>This Cycle time can be divided into its components:</p> <pre>nCtSeconds = ((nCycleTime & 0xFE000000) >> 25; nCtCycles = ((nCycleTime & 0x01FFF000) >> 12; nCtOffset = nCycleTime & 0x00000FFF;</pre>
C	<p>These values can be combined</p> <pre>dTime = nCtSeconds + nCtCycles / 8000 + nCtOffset / 24576000;</pre>

Table 161: Examples: cycle time

Advanced register: frame counter
Note **Different to Marlin SIS:**

Register 610 is only to be used to reset the frame counter.

The **frame counter** feature is controlled by the following advanced feature register:

Register	Name	Field	Bit	Description
0xF1000610	FRMCNT_STAMP	Presence_Inq	[0]	Indicates presence of this feature (read only)
		Reset	[1]	Reset frame counter
		---	[2 to 31]	Reserved
0xF1000614	FRMCNT		[0 to 31]	Frame counter

Table 162: Advanced register: Frame counter

Having this feature enabled, the current **frame counter** value (images read out of the sensor, equivalent to # FrameValid) will be inserted as a 32-bit integer value into any captured image.

Setting the **Reset** flag to 1 resets the frame counter to 0: the **Reset** flag is self-cleared.

Note The 4 bytes of the **frame counter** value will be inserted as the **5th to 8th byte of a line.**

Additionally, there is a register for direct read out of the frame counter value.

Advanced register: trigger counter

The **trigger counter** feature is controlled by the following advanced feature register:

Register	Name	Field	Bit	Description
0xF1000620	TRIGGER_COUNTER	Presence_Inq	[0]	Indicates presence of this feature (read only)
		Reset	[1]	Reset trigger counter
		---	[2 to 31]	Reserved
0xF1000624	TRGCNT	TriggerCounter	[0 to 31]	Trigger counter

Table 163: Advanced register: Trigger counter

Having this feature enabled, the current **trigger counter** value (external trigger seen by hardware) will be inserted as a 32-bit integer value into any captured image.

Setting the **Reset** flag to 1 resets the **trigger counter** to 0: the **Reset** flag is self-cleared.

The **ON_OFF** and **LinePos** fields are simply mirrors of the SIS feature. Settings of these fields are applied to all SIS features.

Note The 4 bytes of the **trigger counter** value will be inserted as the **9th to 12th byte of a line**.



Additionally, there is a register for direct read out of the **trigger counter** value.

Where to find cycle time, frame counter and trigger counter in the image

Figure 108: SIS in the image: cycle time, frame counter, trigger counter

Where to find all SIS values in the image

The following table presents the position of all SIS values (byte for byte) including the endianness of SIS values. (Here SIS has 48 bytes.)

Cycle time [7 to 0]	Cycle time [15 to 8]	Cycle time [23 to 16]	Cycle time [31 to 24]
Byte 1	Byte 2	Byte 3	Byte 4
Frame counter [7 to 0]	Frame counter [15 to 8]	Frame counter [23 to 16]	Frame counter [31 to 24]
Byte 5	Byte 6	Byte 7	Byte 8
Trigger counter [7 to 0]	Trigger counter [15 to 8]	Trigger counter [23 to 16]	Trigger counter [31 to 24]
Byte 9	Byte 10	Byte 11	Byte 12
AOI left [7 to 0]	AOI left [15 to 8]	AOI top [7 to 0]	AOI top [15 to 8]
Byte 13	Byte 14	Byte 15	Byte 16
AOI width [7 to 0]	AOI width [15 to 8]	AOI height [7 to 0]	AOI height [15 to 8]
Byte 17	Byte 18	Byte 19	Byte 20
Shutter [7 to 0]	Shutter [15 to 8]	Shutter [23 to 16]	Shutter [31 to 24]
Byte 21	Byte 22	Byte 23	Byte 24
Gain [7 to 0]	Gain [15 to 8]	Reserved [NULL]	Reserved [NULL]
Byte 25	Byte 26	Byte 27	Byte 28
Output State_1 [7 to 0]	Output State_2 [7 to 0]	Output State_3 [7 to 0]	Output State_4 [7 to 0]
Byte 29	Byte 30	Byte 31	Byte 32
Input State_1 [7 to 0]	Input State_2 [7 to 0]	Reserved [NULL]	Reserved [NULL]
Byte 33	Byte 34	Byte 35	Byte 36
SequenceIndex [7 to 0]	Reserved [NULL]	ColorCoding [NULL]	Reserved [NULL]
Byte 37	Byte 38	Byte 39	Byte 40
Serial number [7 to 0]	Serial number [15 to 8]	Serial number [23 to 16]	Serial number [31 to 24]
Byte 41	Byte 42	Byte 43	Byte 44
SIS user value [7 to 0]	SIS user value [15 to 8]	SIS user value [23 to 16]	SIS user value [31 to 24]
Byte45	Byte46	Byte47	Byte48

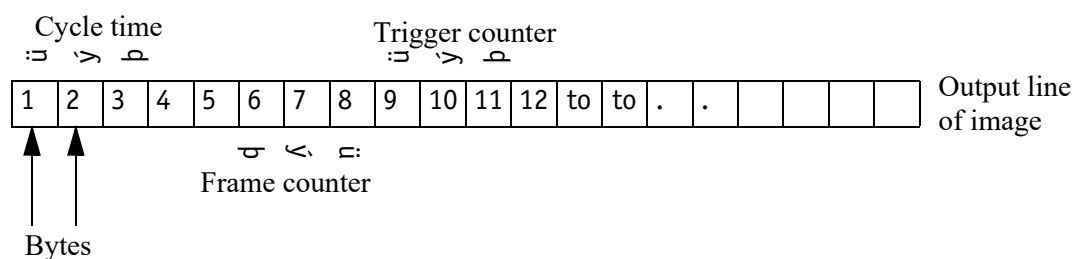
Table 164: All SIS values (increasing order of transmitted pixels)

Software feature control (disable LEDs)

The software feature control register allows to enable/disable some features of the camera (e.g. disable LEDs). The settings are stored permanently within the camera and do not depend on any user set.

Register	Name	Field	Bit	Description
0xF1000640	SWFEATURE_CTRL	Presence_Inq	[0]	Indicates presence of this feature (read only)
		BlankLED_Inq	[1]	Indicates presence of <i>Disable LEDs</i> feature
		---	[2 to 15]	Reserved
		---	[16]	Reserved
		BlankLED	[17]	0: Behavior as described in chapter Status LEDs on page 105 et seq. 1: Disable LEDs. (The LEDs will still show error codes.)
		---	[18 to 31]	Reserved

Table 165: Advanced register: Software feature control (disable LEDs)

Disable LEDs

- To disable LEDs set bit [17] to 1.
- To disable LEDs in SmartView:
Adv3 tab, activate *Disable LED functionality* check box.

The camera does not show any more the status indicators during normal operation:

Examples:

- Power on is not shown
- Isochronous traffic is not shown
- Asynchronous traffic is not shown

Note



During the startup of the camera and if an error condition is present, the LEDs behave as described in chapter [Status LEDs](#) on page 105.

User profiles

Definition Within the IIDC specification **user profiles** are called **memory channels**, known as **user sets**. These are different expressions for the following: storing camera settings into a non-volatile memory inside the camera.

User profiles can be programmed with the following advanced feature register:

Offset	Name	Field	Bit	Description
0xF1000550	USER_PROFILE	Presence_Inq	[0]	Indicates presence of this feature (read only)
		Error	[1]	An error occurred
		---	[2 to 6]	Reserved
		Busy	[7]	Save/Load in progress
		Save	[8]	Save settings to profile
		Load	[9]	Load settings from profile
		SetDefaultID	[10]	Set Profile ID as default
		---	[11 to 19]	Reserved
		ErrorCode	[20 to 23]	Error code See Table 167 on page 332.
		---	[24 to 27]	Reserved
		ProfileID	[28 to 31]	ProfileID (memory channel)

Table 166: Advanced register: User profiles

In general, this advanced register is a wrapper around the standard memory channel registers with some extensions. In order to query the number of available user profiles please check the **Memory_Channel** field of the **BASIC_FUNC_INQ** register at offset **0x400** (see IIDC V1.31 for details).

The **ProfileID** is equivalent to the memory channel number and specifies the profile number to store settings to or to restore settings from. In any case profile #0 is the hard-coded factory profile and cannot be overwritten.

After an initialization command, startup or reset of the camera, the **ProfileID** also indicates which profile was loaded on startup, reset, or initialization.

Note



- The default profile is the profile that is loaded on power-up or an INITIALIZE command.
- A save or load operation delays the response of the camera until the operation is completed. At a time only one operation can be performed.

Store To store the current camera settings into a profile:

1. Write the desired **ProfileID** with the **SaveProfile** flag set.
2. Read back the register and check the **ErrorCode** field.

Restore To restore the settings from a previous stored profile:

1. Write the desired **ProfileID** with the **RestoreProfile** flag set.
2. Read back the register and check the **ErrorCode** field.

Set default To set the default profile to be loaded on startup, reset or initialization:

1. Write the desired **ProfileID** with the **SetDefaultID** flag set.
2. Read back the register and check the **ErrorCode** field.

Error codes

ErrorCode #	Description
0x00	No error
0x01	Profile data corrupted
0x02	Camera not idle during restore operation
0x03	Feature not available (feature not present)
0x04	Profile does not exist
0x05	ProfileID out of range
0x06	Restoring the default profile failed
0x07	Loading LUT data failed
0x08	Storing LUT data failed

Table 167: User profiles: Error codes

Reset of error codes

The **ErrorCode** field is set to zero on the next write access.

Other ways to reset the **ErrorCode**:

- Writing to the **USER_PROFILE** register with the **SaveProfile**, **RestoreProfile** and **SetDefaultID** flag not set.
- Writing 00000000h to the **USER_PROFILE** register.

Stored settings

The following table shows the settings stored inside a profile:

Standard registers	Standard registers (Format_7)	Advanced registers
Cur_V_Frm_Rate	IMAGE_POSITION (AOI)	TIMEBASE
Cur_V_Mode	IMAGE_SIZE (AOI)	EXTD_SHUTTER
Cur_V_Format	COLOR_CODING_ID	IO_INP_CTRL
ISO_Channel	BYTES_PER_PACKET	IO_OUTP_CTRL
ISO_Speed		IO_INTENA_DELAY
BRIGHTNESS		AUTOSHUTTER_CTRL
AUTO_EXPOSURE (Target grey level)		AUTOSHUTTER_LO
SHARPNESS		AUTOSHUTTER_HI
WHITE_BALANCE (+ auto on/off)		AUTOGAIN_CTRL
HUE (+ hue on)		AUTOFNC_AOI (+ on/off)
SATURATION (+ saturation on)		COLOR_CORR (on/off + color correction coefficients)
GAMMA (+ gamma on)		TRIGGER_DELAY
SHUTTER (+ auto on/off)		MIRROR_IMAGE
GAIN		HIGH_SNR
TRIGGER_MODE		LUT_CTRL (on/off + LUT + LutNo)
TRIGGER_POLARITY		SHDG_CTRL (on/off + ShowImage)
TRIGGER_DELAY		DEFERRED_TRANS (HoldImg + NumOfImages)
ABS_GAIN		

Table 168: User profile: stored settings

The user can specify which user profile will be loaded upon startup of the camera.

This frees the user software from having to restore camera settings, that differ from default, after every startup. This can be helpful if third party software is used which may not give easy access to certain advanced features or may not provide efficient commands for quick writing of data blocks into the camera.

Note



- A profile save operation automatically disables capturing of images.
- A profile save or restore operation is an uninterruptable (atomic) operation. The write response (of the asynchronous write cycle) will be sent after completion of the operation.
- Restoring a profile will not overwrite other settings than listed above.
- If a restore operation fails or the specified profile does not exist, all registers will be overwritten with the hard-coded factory defaults (profile #0).
- Data written to this register will not be reflected in the standard memory channel registers.

Pulse-width modulation (PWM): Stingray housing and board level cameras

Note See [Table 31](#) on page 116.



GPDATA_BUFFER

GPDATA_BUFFER is a general purpose register that regulates the exchange of data between camera and host for:

- writing look-up tables (LUTs) into the camera
- uploading/downloading of the shading image

GPDATA_INFO Buffer size query

GPDATA_BUFFER indicates the actual storage range

Register	Name	Field	Bit	Description
0xF100FFC	GPDATA_INFO	---	[0 to 15]	Reserved
		BufferSize	[16 to 31]	Size of GPDATA_BUFFER (byte)
0xF1001000	GPDATA_BUFFER			
...				
0xF10017FC				

Table 169: Advanced register: GPData buffer

Note

- Read the BufferSize before using.
- GPDATA_BUFFER can be used by only one function at a time.



Little endian vs. big endian byte order

- To read or write more than 4 byte data, Read/Write Block accesses to GPDATA_BUFFER are recommended. This increases the transfer speed compared to accessing every single quadlet.
- Each quadlet of the local buffer, containing the LUT data or shading image for instance, has to be swapped byte wise from little endian byte order to big endian byte order before writing on the bus. The reason for this is the difference between the big endian byte order and the little endian byte order of the IEEE 1394 bus on common operating systems (Intel PC).

Bit depth	little endian ⇒ big endian	Description
8 bit	L0 L1 L2 L3 ⇒ L3 L2 L1 L0	L: low byte
16 bit	L0 H0 L1 H1 ⇒ H1 L1 H0 L0	H: high byte

Table 170: Swapped first quadlet at address offset 0

Firmware update

Firmware updates can be carried out via FireWire cable without opening the camera.

Note



Should you need detailed support to use this feature, please contact support at www.alliedvision.com/en/about-us/contact-us/technical-support-repair-/-rma.

Extended version number (microcontroller and FPGA)

The new extended version number for microcontroller and FPGA firmware has the following format (four parts separated by periods; each part consists of two digits):

Special.Major.Minor.Bugfix

or

xx.xx.xx.xx

Digit	Description
First part: Special	Omitted if zero Indicates customer specific versions (OEM variants). Each customer has its own number.
Second part: Major	Indicates big changes Old: represented the number before the dot
Third part: Minor	Indicates small changes Old: represented the number after the dot
Forth part: Bug fix	Indicates bug-fixing only (no changes of a feature) or build number

Table 171: New version number (microcontroller and FPGA)

Appendix

Sensor position accuracy of Stingray cameras

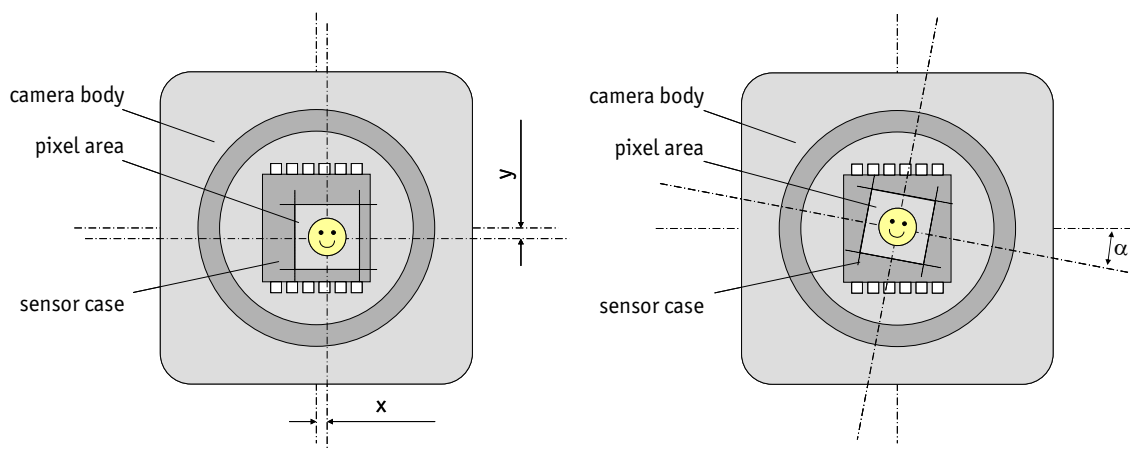

Figure 109: Sensor position accuracy

Criteria	Subject	Properties
Method of Positioning		Optical alignment of the photo sensitive sensor area into the camera front module (lens mount front flange)
Reference Points	Sensor	Center of the pixel area (photo sensitive cells)
	Camera	Center of the lens mount
Accuracy	x/y	± 0.1 mm (sensor shift)
	z	+0/-50 μ m (optical back focal length)
	α	$\pm 0.5^\circ$ (center rotation as the deviation from the parallel to the camera bottom)

Table 172: Criteria of Allied Vision sensor position accuracy

Note x/y tolerances between C-Mount hole and pixel area may be higher.



Index

Numerics

0xF100010 (version info)	288
0xF100040 (advanced feature inquiry) ..	290
0xF1000100 (camera status)	292
0xF1000200 (max. resolution)	293
0xF1000208 (time base)	293
0xF100020C (extended shutter)	196, 295
0xF1000210 (test image)	299
0xF1000220 (sequence mode)	205
0xF1000240 (LUT)	300
0xF1000250 (shading)	302
0xF1000260 (deferred image transport) ..	305
0xF1000270 (frame info)	305
0xF1000274 (frame counter)	305
0xF1000298 (DPC_CTRL)	306
0xF1000300 (input control)	108
0xF1000340 (Delayed IntEna)	309
0xF1000360 (auto shutter control)	309
0xF1000370 (auto gain control)	311
0xF1000390 (autofunction AOI)	312
0xF10003A0 (color correction)	313
0xF1000400 (trigger delay)	314
0xF1000410 (mirror image)	314
0xF1000510 (soft reset)	315
0xF1000520 (High SNR)	316
0xF1000550 (user profiles/memory chan- nels/user sets)	331
0xF1000560 (Max. ISO size S400)	317
0xF1000564 (Max. ISO size S800)	317
0xF1000570 (update timing modes)	319
0xF10005B0 (low noise binning mode) ...	323
0xF1000610 (frame counter)	327
0xF1000620 (trigger counter)	328
0xF1000630 (SIS)	324
0xF1000640 (software feature control)	
disable LEDs	330
0xF1000840 (debounce)	194
0xF100FFC (GPData buffer)	334
0xF1100000 (Parameter-List Update)	321
2 out of 4 H+V sub-sampling (b/w)	
drawing	161
2 out of 4 H+V sub-sampling (color)	
drawing	162
2 x full binning	
drawing	157
2 x horizontal binning	
drawing	156
2 x vertical binning	
drawing	155
A	
Abs_Control (Field) .. 127, 132, 134, 135, 137, 284	
Abs_Control_Inq (Field)	109
access	
binning and sub-sampling	163
Access_Control_Register	273
AccessLutNo (Field)	300
accuracy	
sensor position	336
AddrOffset (Field)	296, 300, 303
Advanced feature inquiry	289
Advanced feature inquiry (advanced register)	
290	
Advanced features	285
activate	287
base address	273
inquiry	271
advanced register	
Advanced feature inquiry	290
Auto gain control	311
Auto shutter control	309
Autofunction AOI	312
Camera status	292
Color correction	313
defect pixel correction	306
Deferred image transport	305
Delayed Integration Enable (IntEna) .	309
Extended shutter	196, 295
Extended version	288
Format_7 mode mapping	322
frame counter	327
Frame information	305
GPData buffer	334

High SNR.....	316	AUTOSHUTTER_HI.....	309
Input control.....	108	AUTOSHUTTER_LO	309
Low noise binning mode	323	B	
low noise binning mode.....	323	bandwidth	215
LUT.....	300	affect frame rate	249
Max. ISO packet	317	available.....	237
Max. resolution	293	deferred image transport.....	172
Mirror image.....	314	FastCapture	175
Output control.....	113	RGB8 format.....	181
Parameter-List Update	321	save in RAW-mode	176
Sequence mode	205	BAYER demosaicing	175, 179
Soft reset	315	BAYER mosaic.....	175
Test images	299	BAYER to RGB	
Time base	293	color interpretation	175
Trigger counter.....	328	binning	153
Trigger delay	314	access.....	163
Update timing modes	319	full	157
User profiles.....	331	horizontal.....	156
algorithm		only Stingray b/w	153
correction data	141	vertical	154
A_M_MODE (Field).....	127, 132, 134, 135, 137	BitsPerValue	300
AOI	142, 233	black level	137
correction data	142	black value	136, 137
appendix	336	black/white camera	
area of interest (AOI).....	142, 235	block diagram.....	125
asynchronous broadcast	200	block diagram	
auto exposure		b/w camera	125
limits.....	309	color camera	126
target grey level	136, 309	block diagrams	
Auto Exposure (CSR register).....	135	cameras	125
auto gain	133, 309	BRIGHTNESS	137, 279
Auto gain control (advanced register).....	311	Brightness	
auto shutter.....	130, 132, 309	inquiry register.....	272
Auto shutter control (advanced register).309		brightness	
auto white balance	130	auto shutter	132
external trigger	130	average.....	133
AUTO_EXPOSURE	135	decrease	309
AUTOFNC_AOI	130, 312	descending	211
AUTOFNC_AOI positioning	131	effects	203
Autofunction AOI (advanced register)	312	IIDC register.....	137
AUTOGAIN_CTRL.....	311	increase	136, 309
Auto_Inq	109	level	140, 143
automatic generation		LUT.....	146
correction data	141	nonlinear	146
AUTOSHUTTER_CTRL	309	reference	132, 133

setting	137	BAYER demosaicing	176
sub-sampling	158	continuous	
variation	308	using Trigger_Mode_15	189
Brightness (CSR register)	137	controlling	
Brightness Control	272	image capture	186
Brightness_inq.	274	correction	
BRIGHTNESS_INQUIRY	274	color	175
buffer		correction data	
LUT	147	algorithm	141
BuildDPData flag	151	AOI	142
advanced register	306	automatic generation	141
bulk trigger	186, 187	requirements	141
bulk trigger (Trigger_Mode_15)	187	shading	139
Bus_Id	253	CSR	253
busy signal	111	shutter	132
C		CSR register	
camera dimensions	85	Auto Exposure	135
2 x IEEE 1394b copper	86	Brightness	137
camera interfaces	100	GAIN	134
camera lenses	98	Temperature	284
Camera status (advanced register)	292	cycle time	
cameras		examples	326
block diagram	125	structure	325
CAMERA_STATUS	292	cycle time (SIS)	213, 324, 325
Camera_Status_Register	253	D	
channel	119	daisy chain	42
color camera		data block packet format	119
block diagram	126	description	119
color coding	170	data exchange buffer	
color codings	170	LUT	147
color correction	175, 179, 180	data packets	119
Allied Vision cameras	179	data path	125
formula	179	data payload size	55, 249
why?	179	data_length	119
Color correction (advanced register)	313	DCAM	41, 215, 253
Color correction (Field)	290	debounce (advanced registers summary)	287
color information	175	debounce time	
Color_Coding	170	for input ports	194
COLOR_CODING_INQ	170	debounce time for trigger	193
common GND		default sequence mode	206
inputs	102	defect pixel correction	
common vcc		advanced register	306
outputs	102	build and store	149
conformity	43	building defect pixel data	150
consequence		calculated mean value	306

- data storing mechanism153
 - max. 2000 defect pixels307
 - mechanisms148
- defect pixel correction (advanced register) .. 306
- defect pixel correction (DPC)306
- deferred image transport172, 305
- Deferred image transport (advanced register) 305
- deferred transport210
- Delayed Integration Enable (IntEna) (advanced register)309
- DelayTime308
- Digital Camera Specification (DCAM)253
- digital video information119
- digitizer146
- disable
 - LEDs330
- disable LEDs
 - software feature control330
- document history25
- DPC (defect pixel correction)306
- DPC data
 - storing mechanism153
- DPC_CTRL306
- DPC_INFO307
- DPC_MEM307
- DPDataSize
 - defect pixel data size (max. 2000)307
- E**
- edge mode (Trigger_Mode_0)111, 186
- effective min. exp. time195
- EnableMemWR (Field)300
- Encapsulated Update (begin/end) ...167, 168
- End of exposure198
- error code
 - user profiles332
- error codes
 - LED106
- example (parameter list)321
- examples
 - cycle time326
- ExpOffset294
- Exposure time
 - (Field)196
- exposure time194
 - 81 Ch register196
 - example195
 - extended shutter295
 - FIFO208
 - formula194
 - longest196
 - long-term integration196
 - minimum195
- Exposure time offset195
- ExpTime (Field)196
- EXTD_SHUTTER295
- extended shutter196
 - FireDemo295
 - FireView295
 - inactive196, 295
 - register295
 - trigger mode186
- Extended shutter (advanced register)196, 295
- Extended version (advanced register)288
- EXTENDED_SHUTTER196
- External GND102
- external signal (SeqMode)206
- external trigger107
- F**
- Fast Parameter Update Timing ..168, 169, 170
- FastCapture
 - bandwidth175
 - deferred image transport305
 - false175
 - only Format_7175
- FastCapture (Field)305
- FireDemo
 - extended shutter295
- FirePackage
 - OHCI API software41
- Firepackage
 - additional checks image integrity214
- Firetool program211
- FireView
 - extended shutter295
- FireWire
 - connecting capabilities51
 - definition49

serial bus	50	CCD models	142
FireWire 400.....	52	gamma LUT	146
FireWire 800.....	52	global pipelined shutter	186
firmware update	335	global shutter	186
focal length	98	GND for RS232.....	102
Format_7 mode mapping (advanced register)		GPData buffer (advanced register)	334
322		GPDATA_BUFFER	144, 145, 147
Format_7 modes		GRAB_COUNT	141
mapping	164	H	
FORMAT_7_ERROR_1	106	hardware trigger	110, 192
FORMAT_7_ERROR_2	106	HDR mode.....	290
formula		heat dissipation	46
color correction	179	high level (SeqMode).....	206
FOV	138	High Signal Noise Ratio (HSNR)	171
FPGA boot error.....	106	High SNR (advanced register).....	316
frame counter	213, 327	High SNR mode	171
frame counter (advanced register)	327	HoldImg	
frame counter (SIS)	324	field	173
Frame information (advanced register) ...	305	flag	173
frame rates	215	mode	173
bus speed.....	216	set.....	305
Format_7	240	HoldImg (Field)	305
maximum	215	horizontal binning	156
tables	236	horizontal mirror function	138
video mode 0.....	239	horizontal sub-sampling (b/w)	
video mode 2.....	239	drawing	158
Frame valid	111	horizontal sub-sampling (color)	
FrameCounter	305	drawing	159
free-run.....	200	HSNR.....	171
full binning.....	157	hue	178
Fval.....	111	offset.....	178
Fval signal	111	I	
G		I/O controlled sequence pointer reset.....	210
gain		I/O controlled sequence stepping mode ..	209
auto.....	133	ID	
auto exposure CSR	133	color coding	170
AUTOFNC_AOI.....	130	IEEE 1394	41
manual	136	Trade Association.....	253
manual gain range.....	128, 136	IEEE 1394 standards	49
ranges	136	IEEE 1394a	
GAIN (CSR register)	134	data transmission	50
GAIN (name).....	134	IEEE 1394b	
GAIN (register).....	129	bandwidths	55
gain CSR.....	136	data transmission	51
gamma function	146		

IIDC	41, 121, 215, 253	IO_INP_CTRL2	108
data structure.....	123, 124	IO_INP_DEBOUNCE	287
isochronous data block packet format	119	IO_OUTP_CTRL1	113
pixel data	119	IO_OUTP_CTRL2	113
trigger delay.....	109	IO_OUTP_CTRL3	113
video data format	120	IO_OUTP_CTRL4	113
YUV 4:1:1	120, 121, 122	isochronous blocks.....	119
YUV 4:2:2	120, 121, 122	isochronous channel number	119
IIDC V1.31	186	isochronous data block packet format	119
IIDC V1.31 camera control standards.....	52	isochronous data packets.....	119
image buffer (RAM)	59	Isochronous Resource Manager (IRM)	318
image capture		ISO_Enable.....	200
controlling.....	186	IsoEnable	210
IMAGE_POSITION.....	233	white balance.....	129
ImageRepeat	209	ISO_Enable mode	200
IMAGE_SIZE	233	multi-shot.....	200
incrementing list pointer	203	one-shot.....	197
input		J	
block diagram.....	107	jitter	198, 202
signals	107	at exposure start.....	202
Input control (advanced register)	108	L	
input mode	108	LED	
input/output pin control.....	308	error codes.....	106
InputMode (Field)	108	indication	106
inputs		status	105
common GND.....	102	LEDs	
general	107	disable.....	330
in detail	107	level mode (Trigger_Mode_1)	186
triggers.....	107	look-up table (LUT)	146, 300
inquiry		user-defined.....	146
software trigger.....	275	Low noise binning mode (advanced register)	
trigger source 0	275	323	
Inquiry register		low noise binning mode (advanced register)	
basic function.....	271	323	
Integration Enable signal.....	111	LUT	300
IntEna	102, 115	data exchange buffer	147
IntEna signal	111, 308	example.....	146
IntEna_Delay	116	gamma	146
IntEna_Out.....	308	general	146
internal trigger	186	loading into camera	147
interpolation		volatile	146
BAYER demosaicing	175, 176	LUT (advanced register)	300
BAYER to RGB	175	LUT_CTRL.....	300
color.....	175	LUT_INFO	300
IO_INP_CTRL1	108		

LUT_MEM_CTRL	300	CCD.....	137
LutNo	300	configuration ROM	257
LutNo (Field)	300	factors	257
M		hue.....	178
Manual_Inq	109	initialize register	260
Max. ISO packet (advanced register)	317	inquiry register video format	260
Max. resolution (advanced register).....	293	inquiry register video mode	261
Maximum resolution (Register)	293	saturation	178
MaxLutSize (Field).....	300	setting brightness.....	137
MAX_RESOLUTION	293	setting gain.....	136
MaxResolution (Field).....	290	OHCI API	
MaxSize (Field)	307	FirePackage.....	41
Max_Value	109	One_Push (Field)	127, 132, 134, 135, 137
MaxValue.....	311	one-push white balance.....	129
Mean		One_Push_Inq	109
defect pixel mean value.....	306	one-shot	197
Memory channel		Trigger_Mode_15	186
error codes.....	304	using Trigger_Mode_15.....	189
memory channels	331	values.....	198
memory channels (user profiles).....	331	one-shot bit.....	197
Min. exp. time + offset	195	one-shot mode.....	197
Minimum exposure time	195	ON_OFF	109
Min_Value	109	ON_OFF (Field).....	127
MinValue	311	optocoupler.....	107
mirror function		output	
horizontal	138	block diagram.....	112
Mirror image (advanced register).....	314	signals.....	111
MSB aligned.....	119	Output control	113
multi-shot	200, 210	Output control (advanced register)	113
external trigger	200	output impulse diagram	
using Trigger_Mode_15.....	189	WaitingForTrigger	115
N		output mode	112
No DCAM object.....	106	ID.....	114
No FLASH object.....	106	Output mode (Field)	113
Node_Id	253	output pin control.....	114
non-uniform illumination	140	outputs	111
non-volatile memory (Flash)	59	common vcc	102
NumOfLuts.....	300	general	107
NumOfLuts (Field)	300	registers	112
O		set by software	116
OFFSET		OutVCC	102
automatic white balance.....	129	P	
offset	194	Packed 12-Bit Mode.....	170
800h.....	137	Packed 12-Bit MONO	170
		Packed 12-Bit RAW	170

packet format.....	119	RGB to YUV	
parameter list		formula.....	181
example.....	169	RGB8 format	181
parameter list (example)	321	rising edge (SeqMode).....	206
Parameter-List Update	167, 168, 169	RS232	102
Parameter-List Update (advanced register) ..	321	RxD_RS232	102
PDS	59, 296	S	
Permanent Data Storage	59, 296	safety	2, 8
Permanent data storage.....	295	heat dissipation.....	46
PI controller	133	lens mounts	45
pin control.....	308	saturation.....	178
PinState (Field).....	108	offset.....	178
PinState flag	112	secure image signature (SIS)	
pixel data	119	definition.....	212
plus integral controller.....	133	scenarios	212
pointer reset.....	203	Sensor.....	336
Polarity (Field).....	108, 113	Sensor position accuracy.....	336
Power		Seq_Length	210
IEEE 1394b.....	100	SeqLength	210
power		SeqMode	
GND	102	description.....	206
presence		sequence	
software trigger	275	deferred mode.....	173
trigger source 0	275	important notes.....	210
Presence_Inq.....	108	modified registers.....	204
Presence_Inq (Field)	109, 127	of images	203
programmable mode (Trigger_Mode_15) 186		one-push white balance	129
pulse-width modulation		OneShot.....	197
signal	111	sequence mode	203
PulseWidthMod signal.....	111	cancel.....	210
Q		changes to registers.....	212
QFCM	166	default.....	206
Quick Format Change Mode.....	165, 168	example of settings.....	211
(QFCM).....	166, 168, 169	features	209
Quick parameter change timing modes	165	flow diagram	208
R		frame rate	204
read value		image size.....	204
trigger input.....	275	implemented.....	205
Readout_Inq.....	109	pointer reset	203
Register mapping (error code).....	106	repeat counter.....	203
repeat counter	203	Sequence mode (advanced register)	205
Requirements		Sequence Reset.....	108
correction data	141	Sequence Step	108
		sequence step mode	206
		SEQUENCE_CTRL	205, 285

SEQUENCE_PARAM.....	205, 285	specifications.....	59
SEQUENCE_STEP.....	205, 285	spectral transmission	
shading		IR cut filter.....	97
correction data.....	139	Stack setup (error code).....	106
shading correction.....	139, 302	Stack start (error code).....	106
shading image.....	140	standard housing.....	86
automatic generation.....	141	Standard Parameter Update Timing.....	165, 166, 319
delay.....	142	Standard Update (IIDC).....	167, 169, 170
Format_7.....	142	status LED.....	105
generation.....	143	Stingray F-033B/C (Specification).....	61
load into camera.....	145	Stingray F-046B (Specification).....	64
load out of camera.....	144	Stingray F-080B/C (Specification).....	67
shading images.....	302	Stingray F-125B/C (Specification).....	70
shading reference image.....	141	Stingray F-145B/C (Specification).....	73
sharpness.....	177	Stingray F-146B (Specification).....	76
SHDG_CTRL.....	142, 302	Stingray F-201B/C (Specification).....	79
SHDG_INFO.....	303	Stingray types.....	42
SHDG_MEM_CTRL.....	296, 303	stored settings	
SHUTTER.....	132	user profile.....	333
Shutter CSR.....	132	structure	
shutter time		cycle time.....	325
formula.....	194	styles.....	39
SHUTTER_MODES.....	186	sub-sampling	
signal-to noise ratio (SNR)		access.....	163
vertical binning.....	155	b/w and color.....	158
signal-to-noise ratio (SNR).....	154	brightness.....	158
signal-to-noise separation.....	154	definition.....	158
single-shot mode.....	210	sy (sync bit).....	119
SIS		symbols.....	39
advanced register.....	324	sync bit (sy).....	119
cycle time.....	213, 324, 325	synchronization value (sync bit).....	119
definition.....	212	system components.....	97
frame counter.....	324	T	
scenarios.....	212, 213	tag field.....	119
trigger counter.....	213, 324	target grey level	
SmartView.....	41	corresponds to Auto_exposure.....	280
SNR.....	154	Target grey level (auto exposure).....	136, 309
Soft reset (advanced register).....	315	Target grey level (SmartView)	
software feature control		corresponds to auto exposure.....	132
disable LEDs.....	330	tCode.....	119
software trigger		TEMPERATURE.....	284
inquiry.....	275	Temperature (CSR register).....	284
write,read.....	277	test image.....	251
Software_Trigger (inquiry register).....	277	b/w cameras.....	251
Software_Trigger_Inq.....	275		

Bayer-coded	252	one-shot	197
color	252	sequence mode	203
color cameras	252	signal	107
configuration register	299	software	200
gray bar	251	synchronize	202
save	298	trigger counter	328
Test images (advanced register)	299	trigger counter (advanced register)	328
TEST_IMAGE	299	trigger counter (SIS)	213, 324
tg	119	trigger delay	190
threshold		advanced CSR	110, 192
defect pixel correction	150, 306	advanced register	110, 192
time base	195	off	110
exposure time	194	on	110
setting	295	Trigger delay (advanced register)	314
trigger delay	109, 190	Trigger Delay CSR	110
Time base (advanced register)	293	trigger delay CSR	191
time base (Register)	293	Trigger delay inquiry register	190
time base ID	294	trigger delay inquiry register	109
time response	198	trigger function	188
TIMEBASE	285, 293	trigger input	
TimeBase (Field)	290	read raw data	275
TPA-		trigger modes	186
IEEE 1394b	100	trigger overrun	213
TPA(R)		trigger source 0	
IEEE 1394b	100	inquiry	275
TPA+	100	TRIGGER_DELAY	110, 191, 192
TPB-		TRIGGER_DELAY_INQUIRY	109, 190
IEEE-1394b	100	TRIGGER_MODE	188
TPB(R)		Trigger_Mode	188
IEEE 1394b	100	Trigger_Mode_0 (edge mode)	111, 186
TPB+	100	Trigger_Mode_1 (level mode)	186
IEEE 1394b	100	Trigger_Mode_15 (bulk trigger)	186, 187
transaction code (tCode)	119	Trigger_Mode_15 (programmable mode)	186
trigger		Trigger_Polarity	188
bulk	186, 187	triggers	107
control image capture	186	input	107
delay	109, 116	Trigger_Source	188
edge	110	Trigger_Source0_Inq	275
external	186	Trigger_Value	188
hardware	110, 192	tripod adapter	87
impulse	197	tripod dimensions	87
IntEna	115	types	
internal	186	Stingray cameras	42
latency time	202	U	
microcontroller	198	U/B_Value (Field)	127

U/V slider range	128	IEEE 1394b.....	100
UNIT_POSITION_INQ.....	233	VP (Power, VCC)	
UNIT_SIZE_INQ	233	IEEE 1394b.....	100
Update timing modes (advanced register)		W	
319		WaitingForTrigger	
user profile		ID 0x0A.....	114
stored settings	333	output impulse diagram	115
user profiles.....	331	WaitingForTrigger signal.....	111
error code	332	white balance	
User profiles (advanced register)	331	auto	130
user sets	331	AUTOFNC_AOI.....	130
user value.....	213	conditions.....	129, 130
V		general.....	126
V/R_Value (Field).....	127	Hue register	178
VCC		one-push	129
IEEE 1394b.....	100	register 80Ch.....	127
Vendor Unique Color_Coding.....	170	six frames	129
Vendor unique Features	271	WHITE_BALANCE	127, 129
vertical binning.....	154		
SNR	155		
vertical sub-sampling (b/w)			
drawing	160		
vertical sub-sampling (color)			
drawing	160		
VG (GND)			
IEEE 1394b.....	100		
video data format			
IIDC V1.31.....	120		
Video data payload	119		
video format			
available bandwidth.....	236		
frame rate	236		
video Format_7			
AOI.....	233		
video formats.....	215		
video information.....	119		
video mode			
CUR-V-MODE.....	277		
Format_7	282		
inquiry register.....	261		
sample C code.....	255		
video mode 0	239		
video mode 2	239		
VMode_ERROR_STATUS	106		
VP			